

# Efficacy of CNC-Diode Laser Combine with Chlorophylls to Eliminate Staphylococcus aureus Biofilm

*by* Suryani Dyah Astuti

---

**Submission date:** 08-Nov-2018 03:55PM (UTC+0800)

**Submission ID:** 1035216357

**File name:** Efficacy-of-CNC-Diode-Laser-Combine-with.pdf (452.49K)

**Word count:** 3191

**Character count:** 17347

# Efficacy of CNC-Diode Laser Combine with Chlorophylls to Eliminate *Staphylococcus aureus* Biofilm

Suryani D. Astuti<sup>1</sup>, Deni Arifianto<sup>2</sup>

bPostgraduate Program in Biomedical Engineering  
Post Graduate School Airlangga University  
Surabaya, Indonesia

<sup>1</sup>suryanidyah@fst.unair.ac.id, <sup>2</sup>denyarifianto23@gmail.com

15  
Nike D.G. Drantantiyas<sup>3</sup>, Aulia M.T. Nasution<sup>4</sup>

\*Postgraduate Program in Engineering Physics  
Institut Teknologi Sepuluh Nopember  
Surabaya Indonesia

<sup>3</sup>grevika@gmail.com, <sup>4</sup>anasution@ep.its.ac.id

Abdurachman

Department of Anatomy  
Faculty of Medicine Airlangga University  
Surabaya Indonesia  
abdurachman1166@gmail.com

**Abstract**— The clinical manifestations of infection by bacteria forming biofilms is their resistance to antibiotic treatment. So, we need an alternative method that is both effective and selective for killing of *Staphylococcus aureus* (*S. aureus*) biofilm bacteria. One of which is a method of photodynamic (PDT) by utilizing light and photosensitizer. The purpose of this study is to build and determine the efficacy of CNC-laser diode, combine with/without chlorophyll to eliminate the microbial *S. aureus* biofilm. CNC (Computer Numerical Control) laser instrument consisted of light source (diode laser), sample holder and controller to control of the intensity values, the number of microplate lines, time duration of irradiation, the stepper motor rotation according to predetermined coordinates, and control the fan. Fan control is aimed to maintain inside temperature of the sample box at room temperature. The characterization of CNC-laser showed the stability of laser power and temperature during irradiation. The 405 nm laser treatment group combine with and without chlorophylls resulted in statistically non-significant efficacy of log CFU ( $p < 0.05$ ) compared to each other. Best efficacy was shown under laser irradiation time of 75 seconds with endogenous PS with the efficacy of 18% and chlorophylls of 22.28%. The result of biofilm viewing of confocal microscopy shows that CNC-laser treatment with exogenous PS (chlorophylls) could eliminate the *S. aureus* biofilm. So CNC-diode laser combine with chlorophylls can eliminate *Staphylococcus* biofilm.

**Keywords**— CNC-laser diode, efficacy, Biofilm, chlorophyll, *Staphylococcus aureus*

## I. INTRODUCTION

Bacteria that can produce biofilms are associated with chronic infectious diseases. *Staphylococcus aureus* (*S. aureus*) is a normal flora that lives in commensal on the skin, nasal passages or humans throat [1]. In abnormal conditions, these bacteria can cause some diseases from mild skin diseases such

as dermatitis, acne vulgaris, cellulitis folliculitis to severe illnesses such as pneumonia, meningitis, osteomyelitis endocarditis, toxic shock syndrome and septicemia [2],[3].

Biofilm is a group of microbial cells irreversibly attached to biological or inanimate surfaces and encased in a matrix of Extracellular Polymeric Substances (EPS) generates its own [4],[5]. This formation allows bacteria to withstand the extreme environment harmfully, survive against antibiotics, disinfectants, even able resistant to immune-system host [5]. The clinical manifestations of infection by bacteria forming biofilms is their resistance to antibiotic treatment. Antibiotic therapy only kill bacterial cells planktonic while the bacteria in the biofilm will survive and develop, and will release from planktonic cells out of the biofilm formation [6]. So, we need an alternative treatment having effective and selective ability for eliminating *S. aureus* biofilm; it is a photodynamic therapy (PDT) [7].

PDT utilizes radical oxygen species that generated from the stimulation of the photosensitizer (PS) by a suitable light source. In the past, PS activation was achieved via a variety of light sources, LED and any various of laser [8]. High power lasers have a complicated system and expensive. However, diode laser has a more simple system, small dimensions, and inexpensive [9]. The choice of PS used in dentistry is strongly dependent on the light source used. Laser diode produces light with a spectral range, based on the composition of the semiconductor material. The use of PDT laser in vitro has been widely investigated. Research results demonstrated that PDT can eliminate the bacterial biofilms [10],[11].

Number of PS on PDT can be increased by administering

exogenous PS. Exogenous PS is PS that is added to enhance the concentration and absorption of light. Efficacy of PDT depends on the type and concentration of PS, quantum yield, output power and irradiation time of diode laser [12].

Organic PS is extracted from natural materials such as chlorophyll from green plants and photosynthetic bacteria. Chlorophylls have physical properties similar to porphyrins, but they have wider absorption area and higher intensity than porphyrins. Chlorophylls are more applicable to be developed for PDT in tumors and cancer [13],[14]. High energy absorption during the process of photosynthesis is caused by the presence of relatively long excitation phase of chlorophyll ( $\leq 10^{-8}$ seconds). The longer phase of singlet excitation of chlorophyll, the higher the electronic energy conversion from the basic level to an excited triplet. Excess energy at the level of the excited triplet chlorophyll gives an opportunity to transfer its energy to nearby oxygen molecules. This reaction produces ROS [15].

The purpose of this study was to build and determine the efficacy of CNC-laser diode combine without/with chlorophyll to eliminate the microbial *S. aureus* biofilm.

## II. METHODS

### A. Bacterial Strain

Bacterial isolate of *Staphylococcus aureus* (ATCC 28923), obtained from the Faculty of Veterinary Medicine - Airlangga University. The isolates were grown in TSA - *Tryptic soy agar* (Oxoid, UK), taken and placed in TSB *Tryptic soy broth* solution (Merk, Germany) and for 24 hours incubated until optical density value of  $OD_{600nm} = 0.5$  is reached, which is equal to  $\sim 10^6$  CFU/mL.

Biofilm cultures were taken of 100 mL in each well in 96 well microplate. Each well was added 20 $\mu$ L of 2% sucrose and placed on a shaker for 4 hours. Sample culture cleaned with Phosphate Buffered Saline pH 7.4 three times and placed in the incubator for 48 hours.

### B. Materials

Chlorophyll was extracted from Alfalfa leaves or *Medicago sativa L* (K-Link liquid, Indonesia) with a concentration of 1.6 mg/ml diluted with sterile normal saline. The absorption spectrum of chlorophyll measured using Shimadzu UV-VIS 1800 spectrometer.

### C. CNC Laser for Treatment

The schematically set up of treatment shown in Figure 1. The block diagram of CNC (Computer Numerical Control) laser instrument for irradiation treatment is shown in Figure 2. It comprises of light source and controller. The light source used to excite photosensitizer in photodynamic mode is a diode laser output wavelengths of 405 nm. The power output is  $82.22 \pm 0.11$  mW focal spot @ $\times$ ed: 0.3  $cm^2$ .

The CNC-laser instrument consists of the sample holder and the microcontroller. Sample holder consists of: 1) a light source (laser diode) (2) laser driver to limit the current and

voltage to the laser. (3) a temperature sensor serves to detect the temperature during the process of irradiation. (4) fans serve to control the temperature to remain constant. If the room temperature irradiation  $> 27^\circ C$ , the fan will turn on. It remains silent if the room temperature irradiation  $\leq 27^\circ C$ . (5) The stepper motor serves to move the microplate in the X and Y coordinates and set the height of the laser on the coordinate Z.

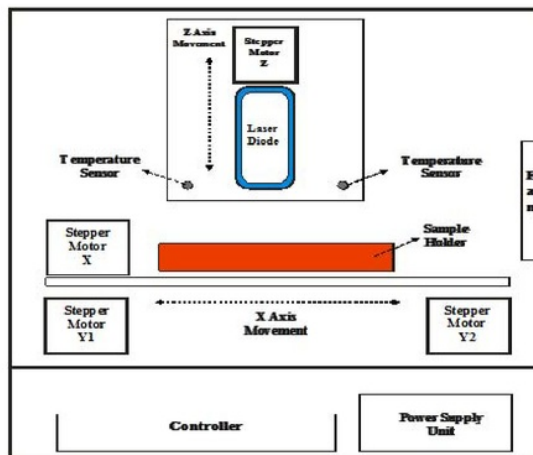

Fig. 1. The schematic CNC laser for irradiation treatment

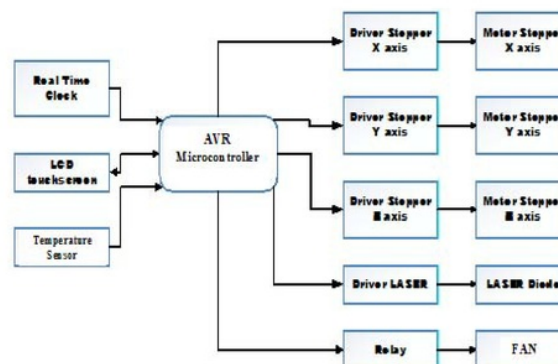

Fig. 2. The block diagram performance of CNC laser for irradiation treatment

The function of the microcontroller is (1) to control the intensity values, the number of microplate lines and time duration of irradiation. (2) to counts time according to a predetermined of time duration. (3) to control the stepper motor rotation according to predetermined coordinates. (4) to activate and deactivate the fan to keep sample box temperature at room temperature.

### D. Sample Treatments

To determine the antimicrobial effect of treatments on *S. aureus* biofilm, the samples were distributed into 4 groups as follow: (1) Groups A (treated with laser), (2) Groups B

photodynamic (treated with laser and chlorophylls), (3) Group C<sup>-</sup> (negative control, no exposure to either chlorophylls), (4) Group C<sup>+</sup> (treated only with chlorophylls). For each group, the experiment was repeated at least 3 times. Treatments of samples done in a completely dark room.

#### E. Crystal Violet Assay

After treatments, samples were cleaned with PBS for 3 times and then incubated for 24 hours. A 150µL of 0.2% crystal violet dyes were then applied and incubated for 15 minutes. Samples were then cleaned with distilled water for three times, and then 50µL 33% glacial acetic acid (GAA) were given. Measurements were then carried out using microplate reader S/N 17539 (Bio-rad, US) at 595nm. Irradiation times are 0; 15s; 30s; 45s; 60s; 75s. For each group, the experiment was repeated at least 4 times. Samples treatments were done in completely dark room

#### F. Biofilm View in Confocal Laser Scanning Microscopy

Morphology of biofilm is visualized by confocal laser scanning microscopy (CLSM). A sample of CLSM was used a cover glass 1.5cm×1.5 cm collagen-containing and taken place in a petri dish with 6cm diameter that filled 3 mL TSA. Biofilm was taken 2 mL culture and stored in an incubator for 48 hours. After treatment, sample was rinsed by 10% PBS at pH 7.4 three times. The sample was dyed using 2% Acridine Orange (Sigma, Aldrich) for 30 minutes and rinsed using PBS pH 7.4 once. The sample was ready to be measured using Confocal Microscopy PV1000 (Olympus) with 200x magnification. The 3D images morphology was visualized by Bioview3D. Image of CLSM is computed by COMSTAT ver2.1 via ImageJ software [16].

#### G. Statistical analysis

The results were log-transformed and analyzed by analysis of variance (ANOVA). A p-value  $\leq 0.05$  was considered to indicate a statistically significant difference. The % efficacy of log CFU/mL from samples treatments defined as:

$$\% \text{ Efficacy} = \left| \frac{\sum \text{ necrosis colony} / \sum \text{ control colony}}{\sum \text{ control colony}} \right| \times 100\%$$

### III. RESULTS AND DISCUSSION

The characteristic of output power of the CNC laser instrument for irradiation treatment is depicted in Figure 3. Figure 4 shows the temperature measurements during irradiation. It can be seen that the temperature is below 45°C. This temperature is still in the range of optimum growth of *S. aureus* so that the bacterial death not caused by an increase in temperature due to irradiation.

PS used in this study is chlorophyll from an extract of Alfalfa leaves or *Medicago sativa L.* with 1.6 mg/ml concentration. The absorption spectrum of chlorophyll was measured using a UV-Visible spectrophotometer. The absorption spectrum of chlorophylls is shown in Figure 5.

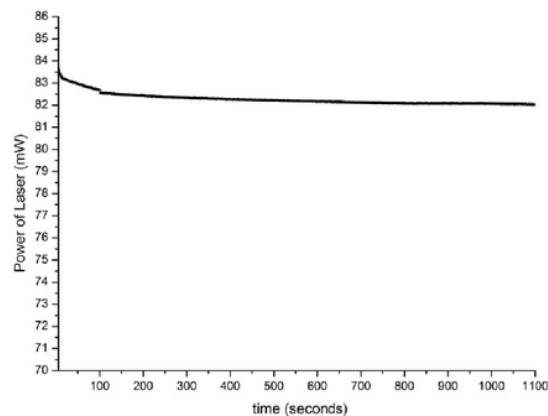

Fig. 3. The steady state of Power of Laser.

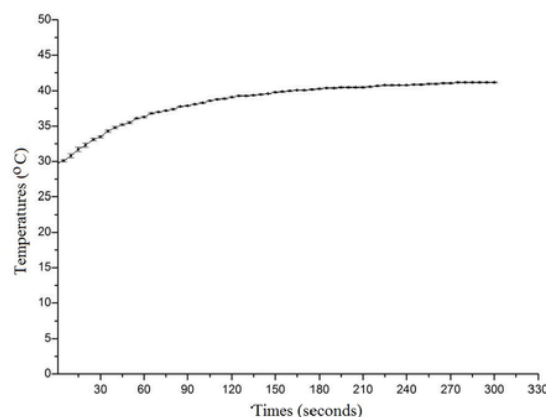

Fig. 4. Temperatures measurement of Laser

The CNC-Diode laser had benefit to control microplate position and real time irradiation. Microplate position and laser position had controlled by a motor servo, and they gave benefit to give distance irradiation accurately. Laser position could accurately move in every well of the microplate. The user could easily use it with touchscreen and understanding of language performance.

The absorption percentage of PS will affect the production of ROS. The concentration of oxygen and PS, the effectiveness of the light source holds an important role in the success of the PDT [17]. The absorption spectrum of exogenous PS from Alfalfa leaves or *Medicago sativa L.* indicates good absorption at a wavelength of blue and red. Based on these results, the quantum yield of the laser diode at 405 nm [18] is 92.97%.

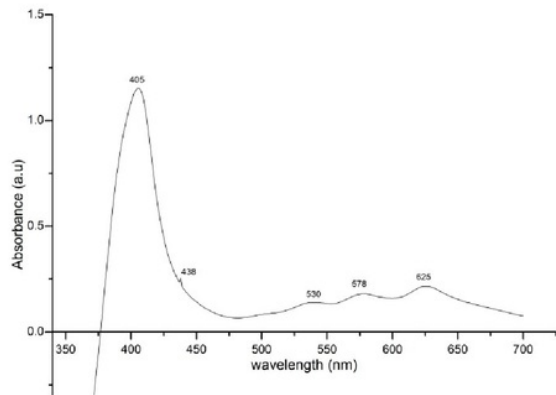

Fig. 5. The absorption spectrum of chlorophyll.

Results of PDT treatment with endogen PS is shown in Figure. 6. The laser at 405 nm treatment group resulted in a not significant efficacy of log CFU/mL ( $p < 0.05$ ) compared to each other. Best efficacy was shown under laser irradiation time 75 seconds with efficacy 18.95%.

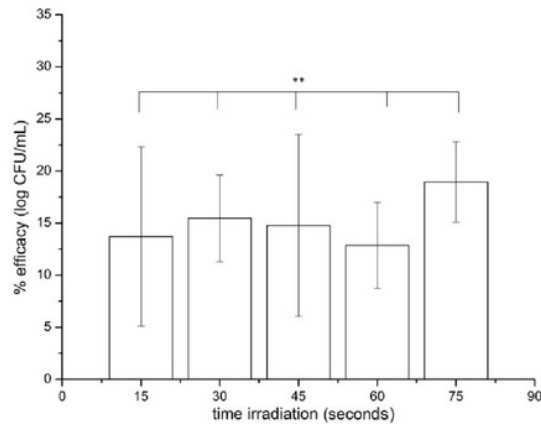

Fig. 6. Results of PDT treatment with endogenous PS. Marker \*\* shows not significant level in ANOVA one-way test  $p > 0.05$ .

The endogenous porphyrin of *S. aureus* consists of Uroporphyrin (89%)[19] and Coproporphyrin III (68.3 - 74.6%)[20]. The absorbance of this porphyrin is in the blue region (405 nm), so suitable for laser spectrum.

Results of PDT treatment with exogenous PS is shown in Fig 7. The laser 405 nm treatment group resulted in a non-significant efficacy of log CFU ( $p < 0.05$ ) compared to each other. Best efficacy was shown under laser irradiation time 75s with efficacy 22.28%.

Results of biofilm viewing of confocal microscopy for the control group (without and with exogenous PS) and CNC-laser treatment group (without and with exogenous PS) are shown in Fig.8. They had difference morphology and adding of

chlorophyll gave less thickness and surface on biofilm. Table 1. showed the parameter measurement of biofilm after treatment.

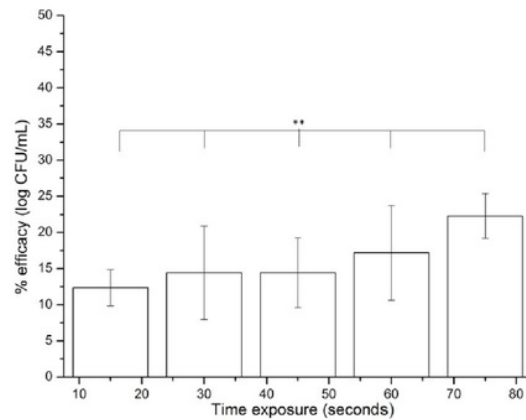

Fig. 7. Results of PDT treatment with exogenous PS. Marker \*\* shows not significant level in ANOVA one-way test  $p > 0.05$ .

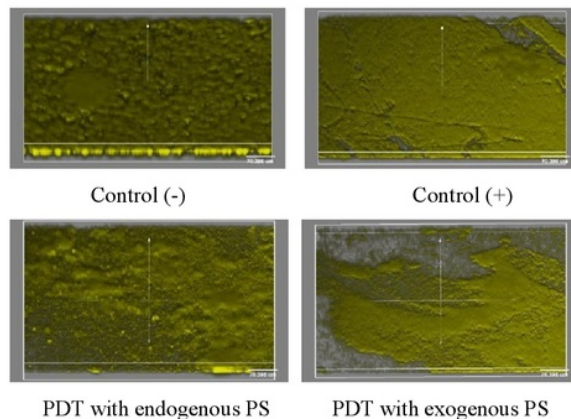

Fig. 8. Biofilm viewing of confocal microscopy using Bioview3D

Results of confocal laser scanning microscopy is an image that will show some parameters and properties of biofilms [21]. Biomass of biofilm showed turbidity or the ratio between volume and surface area. Biomass measurement in each treatment showed that the irradiation of laser and the addition of exogenous photosensitizer provide a decrease of biomass. The maximum thickness of biofilm showed a maximum altitude of community bacteria that are able to produce. The average height biofilm is a normalized height of biofilm. From the results of measurements of heights, laser irradiation and the addition of the sensitizer able to reduce the height of the biofilm. Roughness state has a relationship with the height of the biofilm. This parameter is the distance of biomass each other or can be inferred roughness biofilm. Biofilm surface area is the region that occupied by a community of bacteria.

TABLE I. PARAMETER MEASUREMENT OF BIOFILM

Parameter	Control (-)	Control (+)	PDT (-)*	PDT (+)**
Biomass ( $\mu\text{m}^3/\mu\text{m}^2$ )	15.25	8.09	9.19	5.37
Max Thick ( $\mu\text{m}$ )	57	41	33	26
Roughness State	1.05	1.08	1.10	1.07
Surface area ( $\mu\text{m}^2$ )	$16.02 \times 10^6$	$9.02 \times 10^6$	$9.41 \times 10^6$	$6.12 \times 10^6$
Average Thickness (entire surface ( $\mu\text{m}$ ))	23.68	15.89	13.11	9.87

PDT (-)\* = PDT with endogenous PS

PDT (+)\*\* = PDT with exogenous PS

The result of biofilm viewing of confocal microscopy showed that CNC-laser treatment with exogenous PS (chlorophylls) could eliminate the *S. aureus* biofilm.

#### IV. CONCLUSION

The characterization of CNC-laser showed the stability of laser power and temperature during irradiation. The 405 nm laser treatment combine with and without chlorophylls resulted in the non-significant efficacy of log CFU ( $p < 0.05$ ) compared to each other. Best efficacy was shown under laser irradiation time of 75 seconds with endogenous PS efficacy of 18 % and chlorophylls 22.28%. The confocal microscopy image of the biofilm shows that CNC-laser treatment with exogenous PS (chlorophylls) could eliminate the *S. aureus* biofilm. So CNC-diode laser combine with chlorophylls can eliminate *S. aureus* biofilm.

#### ACKNOWLEDGMENT

We are grateful to Biophysics Research Group in Airlangga University and Photonics Engineering Research Group at the Engineering Physics - the Institut Teknologi Sepuluh Nopember, Indonesia for the ongoing collaboration.

#### REFERENCES

- [1] F. D. Lowy, "Staphylococcus aureus Infections," *N. Engl. J. Med.*, vol. 339, pp. 520–532, 1998.
- [2] K. Plata, A. E. Rosato, and G. Węgrzyn, "Staphylococcus aureus as an infectious agent : overview of biochemistry and molecular genetics of its pathogenicity," *Acta Biochim. Pol.*, vol. 56, no. 4, pp. 597–612, 2009.
- [3] N. K. Archer, M. J. Mazaitis, J. W. Costerton, J. G. Leid, M. E. Powers, and M. E. Shirtliff, "Staphylococcus aureus biofilm: Properties , regulation, and roles in human disease," *Virulence*, vol. 2, no. 5, pp. 445–459, 2011.
- [4] S. Periasamy, H.-S. Joo, a. C. Duong, T.-H. L. Bach, V. Y. Tan, S. S. Chatterjee, G. Y. C. Cheung, and M. Otto, "How Staphylococcus aureus biofilms develop their characteristic structure," *Proceedings of the National Academy of Sciences*, vol. 109, no. 4, pp. 1281–1286, 2012.
- [5] C. Babra, J. G. Tiwari, G. Pier, T. H. Thein, R. Sunagar, S. Sundareshan, S. Isloor, N. R. Hegde, S. de Wet, M. Deighton, J. Gibson, P. Costantino, J. Wetherall, and T. Mukkur, "The persistence of biofilm-associated antibiotic resistance of Staphylococcus aureus isolated from clinical bovine mastitis cases in Australia," *Folia Microbiol. (Praha)*, vol. 58, no. 6, pp. 469–474, 2013.
- [6] P. S. Stewart, "Mechanisms of antibiotic resistance in bacterial biofilms.," *Int. J. Med. Microbiol.*, vol. 292, no. 2, pp. 107–113, 2002.
- [7] A. Taraszewicz, G. Fila, M. Grinholc, and J. Nakonieczna, "Innovative strategies to overcome biofilm resistance.," *BioMed Research International*, vol. 2013, 2013.
- [8] K. Konopka and T. Goslinski, "CRITICAL REVIEWS IN ORAL BIOLOGY & MEDICINE Photodynamic Therapy in Dentistry.," *J. Dent. Res.*, vol. 86, no. 8, pp. 694–707, 2007.
- [9] A. Kübler, C. Niziol, M. Sidhu, A. Dünne, and J. A. Werner, "Eine Kosten – Effektivitäts – Analyse der photo – dynamischen Therapie mit Foscan ( Foscan – PDT ) im Vergleich zu einer palliativen Chemotherapie bei Patienten mit fortgeschrittenen Kopf – Halstumoren in Deutschland.," *Laryngorhinootologie*, vol. 84, pp. 725–732, 2005.
- [10] M. Baffoni, L. J. Bessa, R. Grande, M. Di Giulio, M. Mongelli, A. Ciarelli, L. Cellini, M. Baffoni, B. Lj, R. Grande, D. G. M. M. Mongelli, A. Ciarelli, and C. L. Laser, "Laser irradiation effect on Staphylococcus aureus and Pseudomonas aeruginosa biofilms isolated from venous leg ulcer.," *Int. Wound J.*, pp. 1–8, 2011.
- [11] S. F. G. Vilela, J. C. Junqueira, J. O. Barbosa, M. Majewski, E. Munin, and A. O. C. Jorge, "Photodynamic inactivation of Staphylococcus aureus and Escherichia coli biofilms by malachite green and phenothiazine dyes: An in vitro study.," *Arch. Oral Biol.*, vol. 57, no. 6, pp. 704–710, 2012.
- [12] N. Chiniforush, M. Pourhajibagher, S. Shahabi, E. Kosarieh, and A. Bahador, "Can Antimicrobial Photodynamic Therapy (aPDT) Enhance the Endodontic Treatment?," *Laser Appl. Med. Sci. Res. Cent.*, vol. 7, no. 2, pp. 76–85, 2016.
- [13] M. C. DeRosa and R. J. Crutchley, "Photosensitized singlet oxygen and its applications.," *Coord. Chem. Rev.*, vol. 233–234, pp. 351–371, 2002.
- [14] F. Vatansever, W. C. M. a de Melo, P. Avci, D. Vecchio, M. Sadasivam, A. Gupta, R. Chandran, M. Karimi, N. a. Parizotto, R. Yin, G. P. Tegos, and M. R. Hamblin, "Antimicrobial strategies centered around reactive oxygen species - bactericidal antibiotics, photodynamic therapy, and beyond.," *FEMS Microbiol. Rev.*, vol. 37, no. 6, pp. 955–989, 2013.
- [15] M. Michalik and T. H. P. Brotsudarmo, "Reconstitution Approach to Tune Spectral Features of Light Harvesting Complexes for Improved Light Absorption and Energy Transfer.," *Energy Procedia*, vol. 47, pp. 113–122, 2014.
- [16] M. Vorregaard, "Comstat2 - a modern 3D image analysis environment for biofilms," Technical University of Denmark, 2008.
- [17] J. Y. Nagata, N. Hioka, E. Kimura, V. R. Batistela, R. S. S. Terada, A. X. Graciano, M. L. Baesso, and M. F. Hayacibara, "Antibacterial photodynamic therapy for dental caries: Evaluation of the photosensitizers used and light source properties.," *Photodiagnosis Photodyn. Ther.*, vol. 9, no. 2, pp. 122–131, 2012.
- [18] S. D. Astuti, A. Zaidan, E. M. Setiawati, and Suharningsih, "Chlorophyll mediated photodynamic inactivation of the blue laser on Streptococcus mutans.," *AIP Conf. Proc. 1718*, vol. 120001, p. 120001, 2016.
- [19] Y. Nitzan and M. Kauffman, "Endogenous porphyrin production in bacteria by delta-aminolaevulinic acid and subsequent bacterial photooxidation.," *Lasers Med. Sci.*, vol. 14, no. 4, pp. 269–277, 1999.
- [20] Y. Nitzan, M. Salmon-Divon, E. Shporen, and Z. Malik, "ALA induced photodynamic effects on gram positive and negative bacteria.," *Photochem. Photobiol. Sci.*, vol. 3, no. 5, pp. 430–435, 2004.
- [21] Z. Lewandowski and H. Beyenal, *Fundamentals of Biofilm Research*, Second edi. CRC Press, 2014.

# Efficacy of CNC-Diode Laser Combine with Chlorophylls to Eliminate Staphylococcus aureus Biofilm

## ORIGINALITY REPORT

9%

SIMILARITY INDEX

7%

INTERNET SOURCES

8%

PUBLICATIONS

0%

STUDENT PAPERS

## PRIMARY SOURCES

1

[toc.proceedings.com](http://toc.proceedings.com)

Internet Source

2%

2

Sinari Alfat Sunarko, Wiwied Ekasari, Suryani Dyah Astuti. " Antimicrobial effect of pheophytin A activation with diode laser to ", Journal of Physics: Conference Series, 2017

Publication

1%

3

Totok Ruki Biyanto, Naindar Afdanny, Muhammad Salman Alfarisi, Toto Haksoro, Shita Agustin Kusumaningtyas. "Optimization of acid gas sweetening plant based on least squares — Support Vector Machine (LS-SVM) Model and Grey Wolf Optimizer (GWO)", 2016 International Seminar on Sensors, Instrumentation, Measurement and Metrology (ISSIMM), 2016

Publication

1%

4

[www.laser-therapy.us](http://www.laser-therapy.us)

Internet Source

1%

5	<a href="http://www.spandidos-publications.com">www.spandidos-publications.com</a> Internet Source	1%
6	<a href="http://www.esp.org">www.esp.org</a> Internet Source	1%
7	<a href="http://jdr.sagepub.com">jdr.sagepub.com</a> Internet Source	<1%
8	<a href="http://wrap.warwick.ac.uk">wrap.warwick.ac.uk</a> Internet Source	<1%
9	Araújo, N. C., C. R. Fontana, V. S. Bagnato, and M. E. M. Gerbi. "Photodynamic antimicrobial therapy of curcumin in biofilms and carious dentine", <i>Lasers in Medical Science</i> , 2014. Publication	<1%
10	Misba, Lama, Shatavari Kulshrestha, and Asad U. Khan. "Antibiofilm action of a toluidine blue O-silver nanoparticle conjugate on <i>Streptococcus mutans</i> : a mechanism of type I photodynamic therapy", <i>Biofouling</i> , 2016. Publication	<1%
11	Springer Series on Biofilms, 2014. Publication	<1%
12	<a href="http://digital.library.adelaide.edu.au">digital.library.adelaide.edu.au</a> Internet Source	<1%
13	<a href="http://www.sciencedomain.org">www.sciencedomain.org</a> Internet Source	<1%



14

Reza Fekrazad, Farzaneh Khoei, Neda Hakimiha, Abbas Bahador. "Photoelimination of Streptococcus mutans with two methods of photodynamic and photothermal therapy", Photodiagnosis and Photodynamic Therapy, 2013

Publication

<1%

15

"Table of content", 2016 International Seminar on Sensors, Instrumentation, Measurement and Metrology (ISSIMM), 2016

Publication

<1%

Exclude quotes Off

Exclude matches Off

Exclude bibliography On

# Efficacy of CNC-Diode Laser Combine with Chlorophylls to Eliminate Staphylococcus aureus Biofilm

---

## GRADEMARK REPORT

---

FINAL GRADE

**/0**

GENERAL COMMENTS

**Instructor**

---

PAGE 1

---

PAGE 2

---

PAGE 3

---

PAGE 4

---

PAGE 5

---