

Detection of magnesium ion concentration using fiber coupler based displacement sensor with concave mirror target

by Miratul Khasanah

Submission date: 15-Jun-2019 03:51PM (UTC+0800)

Submission ID: 1143871290

File name: Optik_Vol_158_-2018_-Magnesium_sensor-Yasin.pdf (1.32M)

Word count: 2659

Character count: 13506



Original research article

Detection of magnesium ion concentration using fiber coupler based displacement sensor with concave mirror target

M. Yasin^{a,*}, Samian^a, M. Khasanah^b^a Physics Department, Faculty of Science and Technology, Airlangga University, Surabaya 60115, Indonesia^b Chemistry Department, Faculty of Science and Technology, Airlangga University, Surabaya 60115, Indonesia

ARTICLE INFO

Article history:

Received 2 October 2017

Received in revised form 5 December 2017

Accepted 6 December 2017

Keywords:

Fiber coupler

Displacement sensor

Concave mirror

Refraction

ABSTRACT

Detection of magnesium ion concentration was successfully demonstrated using a fiber coupler based displacement sensor probe in conjunction with a concave mirror target. Analysis of peak voltage result, which was obtained by moving a sensing port displacement from a fixed concave mirror (CM) was found to be useful to detect a magnesium ion concentration, which is filled in between the probe and target. The proposed sensor is capable for measuring magnesium ion with variation of concentration 0–5%. The resolution of the sensor can be achieved at 0.2%. It was also observed that the use of CM with a longer focal length improves the sensitivity of the sensor. The high sensitivity, the small size, the ease fabrication process, and the bio-compatibility of the proposed device are appealing characteristics that makes it ideal for practical bio-sensing applications.

© 2017 Elsevier GmbH. All rights reserved.

1. Introduction

Detections of refractive index and concentration of liquid solution have widely been reported using various fiber-optic sensors [1–5]. Owing to the intrinsic characteristics of the optical fiber, these sensors are in general simple to fabricate, compact, robust, immune to electromagnetic radiation, chemical and biological inert, and can be integrated in complex networks for real-time multiple parameter sensing. In recent years, many important advances were achieved in the fiber optic sensor technology; in terms of sensitivity, resolution, dynamic range, response time, signal to noise ratio and fabrication techniques. These advances have also promoted the development of optical fiber chemical sensors and biosensors [1,2]. For instance, the side-emitting technique was conducted using fiber optic micro-bend [3] and tapered fiber [4] to detect refractive index of chlorinated water and concentration of uric acid, respectively. Optical fibers coated with silver thin layer [5] and nanocomposite of ZnO-polypyrrol [6] were also used to detect concentration of uric acid and manganese ion based on surface plasmon resonance (SPR). Coreless fiber [7] and thin core fiber [8] connected to single mode fiber were used to detect concentration of sucrose and refractive index of solution, respectively.

A method based on displacement sensor can also be used to measure the concentration or refractive index of solution. For instance, a displacement sensor with a bundled fiber probe was capable of measuring refractive of solution [9], glucose concentration [10], calcium [11] and salinity [12]. This type of sensor works based on detection the output voltage as the displacement between sensor probe and mirror immersed in liquid of the solution sample is varied. Fiber coupler is an

* Corresponding author.

E-mail address: yasin@fst.unair.ac.id (M. Yasin).

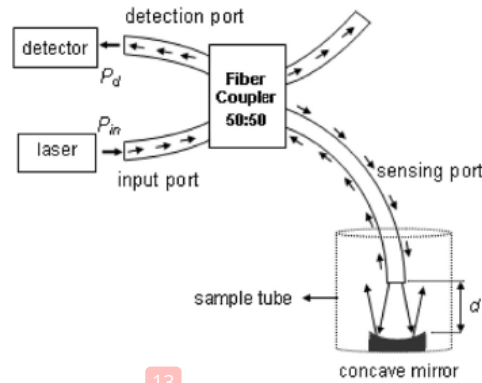

Fig. 1. Design of magnesium ion sensor using fiber coupler with concave mirror as reflector.

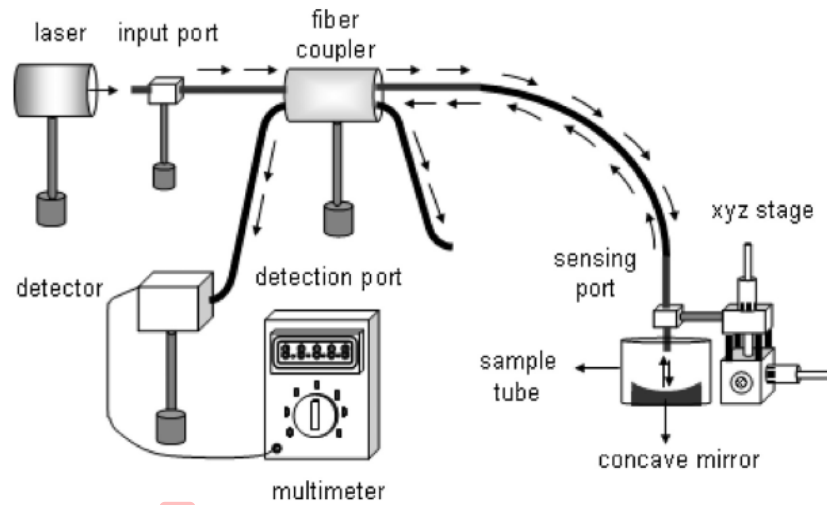

Fig. 2. Experimental setup for magnesium ion concentration sensor.

optical device that can be used to split a beam of light. It was used as a displacement sensor using a mirror as a target [13]. Based on the displacement sensor, fiber coupler was also employed as a level sensor [14] and a Rhodamine B concentration sensor [15] using a concave mirror (CM) as a target in conjunction with a green light source.

In this paper, we propose a new displacement sensor for measuring magnesium ion concentration using a fiber coupler as a probe and a concave mirror as a target. The magnesium ions detection is explored in this study since the ion is very important for the human in energy metabolism process, protein synthesis, muscle contraction, fat breakdown, DNA stability, and cell growth. Lack of magnesium ions in the body will affect health even can cause disease and cancer [16]. Therefore, the magnesium ions sensing device is becoming important especially for the food and beverage industry in order to meet the needs of magnesium ions that are perceived by the body.

2. Working principle of the sensor

Mechanism of magnesium ion detection using fiber coupler and concave mirror (CM) is shown in Fig. 1. Light source of the laser is coupled to input port of the coupler, part of the output light beam from the sensing port (P_e) enter to concave mirror. Medium between sensor port and CM is the testing sample. Partial of the reflected light beam from CM passed through a sensing port (P_b) and then transmitted to the detection port (P_d). The distance between sensing port and CM is attributed by d . If position of sensing port is changed in relation to CM, then the detected optical power as function of d is given by [15];

$$P_d = P_0 \left(1 - \exp \left(- \frac{2(d-f)^2/f^2}{\left(\frac{d^2-2df}{(d-f)a} \tan \sin^{-1} \left(\frac{NA}{n} \right) + 1 \right)^2} \right) \right) \quad (1)$$

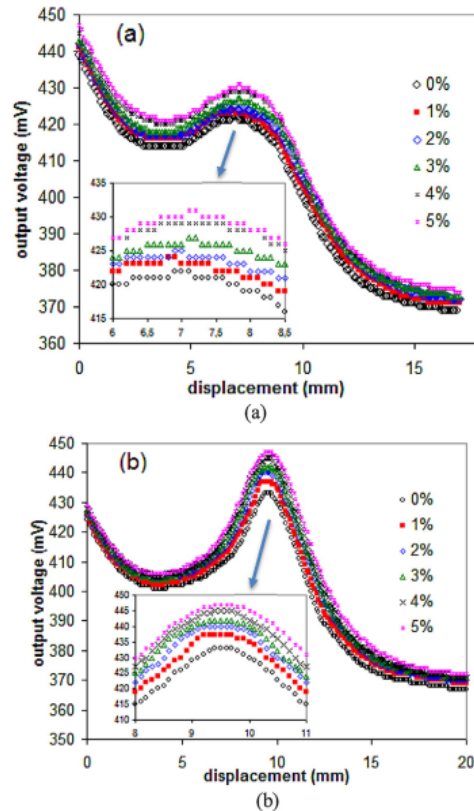

Fig. 3. Output voltage against the the displacement of sensing port as (a) CM 1 and (b) CM 2 was used as a target.

where a , NA , f and n is core of radius, numerical aperture, focal length of CM and refractive index of medium between sensing port and CM, respectively. P_0 can be written by equation as follows;

$$P_0 = 1.15cr(1 - cr)(10^{-0.1L_e} - 2 \times 10^{-0.1D})^2 P_{in}, \quad (2)$$

where cr , L_e , and D are coupling ratio, excess loss, and directivity of fiber coupler respectively. While P_{in} optical power of the laser which is coupled to input port [13].

Optical power of laser is measured by an optical detector using digital voltmeter in term of output voltage (P_d). Output power is proportional to output voltage. When Eq. (1) is simulated, we can obtain the curve showing the relationship between output voltage (V) and d . The curve also indicates a peak voltage at a certain location. The value of V_p increase with refractive index of medium. If we assumed that refractive index is a linear function to magnesium ion concentration in solution as a medium, then the test sample of magnesium ion concentration can be read from the peak voltage. Variation of position scanning between sensing port and concave mirror is used to obtained peak voltage.

3. Experimental Setup

The schematic experimental setup for the proposed magnesium ion concentration sensor is shown in Fig. 2. It consists of a He-Ne laser (with wavelength of 632.8 nm and maximum power of 10 mW), fiber coupler and silicon detector. The fiber coupler probe was constructed from a multimode plastic fiber with structure 2×2 , diameter of 1 mm, 50/50 splitting ratio, 4 dB insertion loss and 1.6 dB excess loss. A CM with two different focal length 4.5 and 6 mm was used as reflector. CM was placed on the bottom sample tube with diameter of 4 cm and 3 cm height.

The positioning of the fiber coupler sensing port was accomplished by mounting it on a micro-displacement meter, which was rigidly attached to a vibration free table. Light from the fiber coupler input port was coupled into the sensing port. The signal from sensing port was measured by moving the probe away from the zero point, where the reflective surface of concave mirror and the probe were in close contact. The signal from the optical detector was converted into voltage and was measured by a digital voltmeter. The output intensity was measured by changing the position of the fiber coupler sensing port, which functions as probe from 0 to 15 mm in step of 100 μ m. The measurements were carried out for magnesium

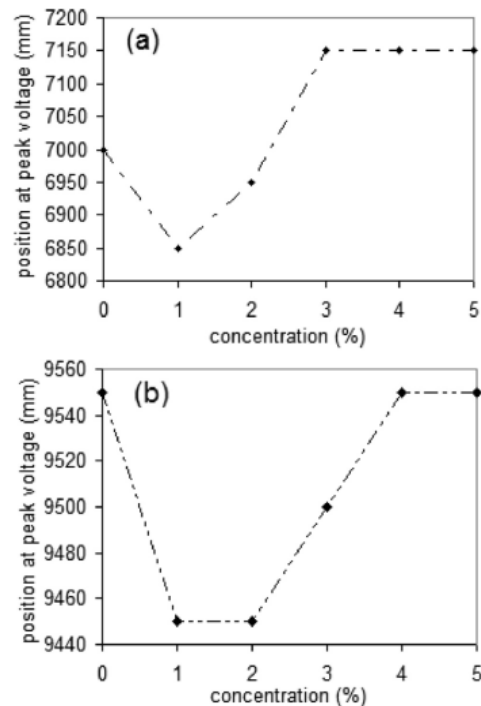

Fig. 4. Position at peak voltage versus magnesium ion concentration for (a) CM 1 and (b) CM 2.

ion with concentrations of 1, 2, 3, 4 and 5%. During the experiment, temperature was kept constant to that error due to temperature fluctuation is negligible.

4. Result and Discussion

Detection of magnesium ion concentration was obtained by monitoring the output voltage while the displacement between the sensing port and CM is varied. The initial position of the sensing port is about 2 mm above the center of the CM. The curves related to the output voltage as function of displacement sensing port was measured for two different CMs for comparison purpose. The results are analyzed and plotted as shown in Fig. 3. Figs. 3(a) and (b) shows the displacement curves with CM1 and CM2, which has a focal length 6 and 12 mm, respectively. The measurement error for both curves is obtained at around 0.6 mV. It is shown that the peak voltage position was obtained at around 7.0 mm and 9.5 mm for the displacement curves with CM1 and CM2, respectively. It is worthy to note that CM 1 and CM 2 has a diameter of 9.0 mm and 12.0 mm, respectively. In the experiment, the starting position of sensing port was at 2.0 m from surface of concave mirror. Compare to reference of 12, the main novelty of the proposed setup is applying fiber coupler probe as element sensing. In this probe, we have a first peak voltage at very close distance, therefore the sensor is suitable for a shorter distance measurement.

Figs. 4(a) and (b) show the peak voltage position at various magnesium ion concentrations for CM1 and CM2 target respectively. It is shown from both figures that peak voltage position changes irregularly with the variation of magnesium ion concentration. Therefore, it is difficult to predict magnesium ion concentration using the peak voltage position.

Correlation between peak voltage value and magnesium ion concentration is shown in Fig. 5. It indicates a linear trend relation between the peak voltage and magnesium ion concentration. The linearity is more than 99%. Therefore, we can determine value of concentration based on value of peak voltage. Slope of the curve in Fig. 5 defines sensitivity of the sensor, which indicates CM2 produces a better sensitivity than that of CM1. This is attributed to the longer focal length that allows the sensing fiber port to collect more light and increases the sensitivity. The refractive index of various magnesium ion concentrations was also measured using Abbe refractometer and the result is summarized in Fig. 6. The result shows that the refractive index is linearly correlated with the concentration. Therefore, this approach can be used for detection of magnesium ion concentration.

The stability of the sensor was then tested for 720 s for each interval 30 s and the result is presented in Fig. 7. Fig. 7 shows the sensor has a high stability with standard of deviation is 0.4 mV (0.1%) and 0.5 mV (0.11%) for CM 1 and CM 2, respectively. Resolution of the sensor is defined by ratio of standard deviation over sensitivity (slope of the linear curve). Overall, performance of the proposed magnesium ion concentration sensor using fiber cou-

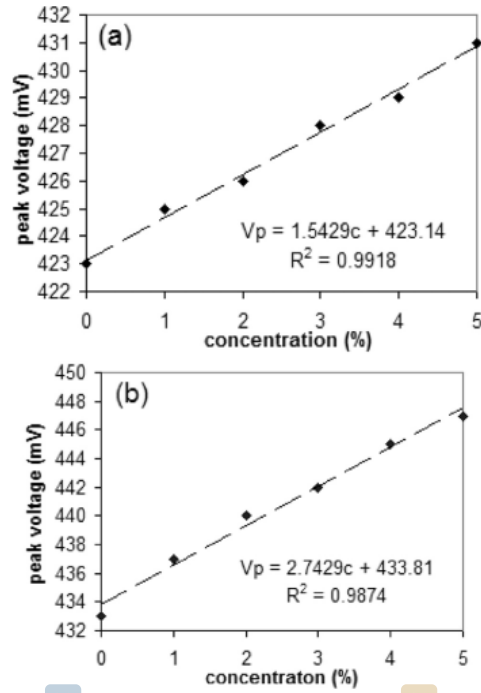

Fig. 5. Peak voltage as a function of magnesium ion concentration for (a) CM 1 and (b) CM 2.

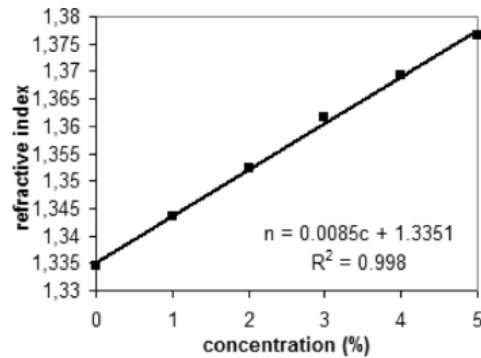

Fig. 6. Result of refractive index measurement versus a magnesium ion concentration.

Table 1
 Performance of the sensor for magnesium ion detection with CM 1 and CM 2.

Parameters	Value	
	CM 1	CM 2
Sensor range (%)	0 – 5	0 – 5
Linear region (%)	0 – 5	0 – 5
Sensitivity (mV/%)	1.54	2.75
Resolution (%)	0.3	0.2

pler probe for CM 1 and CM 2 is summarized in Table 1. Table 1 shows that sensitivity of the sensor with CM 1 is higher than sensor with CM 2, therefore the sensor resolution with CM 2 is lower than CM 1 (1/1.5 times). The results indicate that fiber coupler based displacement sensor can be used for detection of magnesium ion concentration. During the experiment, the error due to this temperature variation is negligible as the temperature is kept constant at 25°C.

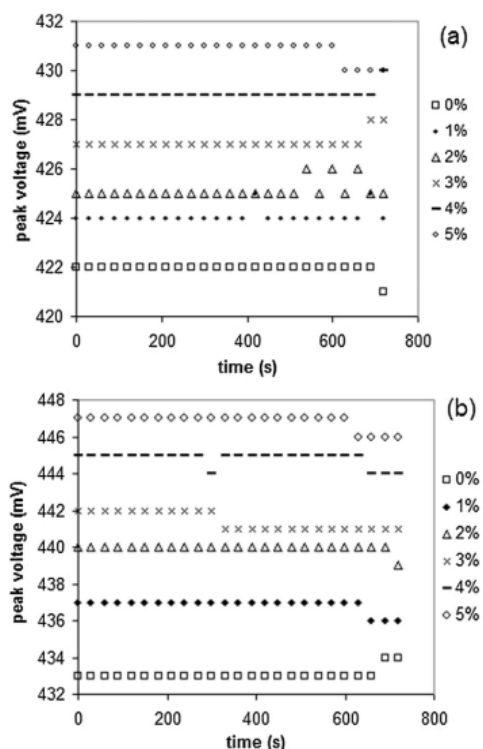

Fig. 7. Stability of the sensor for (a) CM 1 and (b) CM 2.

Based on a simple calculation, a response time or bandwidth of optical detector is used in this experiment can be found at 0.175 kHz.

5. Conclusion

Fiber optic coupler based displacement sensor configured with CM was proposed and demonstrated for detection of magnesium ion concentration. The results shows that a peak voltage of the sensor is linear to the concentration with the best resolution is obtained at 0.2% and range of 0–5%. The use of CM with a longer focal length improves the sensitivity of the sensor. The simplicity and low cost of the sensor make it suitable for various industrial applications.

Acknowledgement

This work was supported by the Airlangga University through “Mandat Grant” No: 569/UN3/2017.

References

- [1] Xu-dong Wang, Otto S. Wolfbeis, Fiber-optic chemical sensors and biosensors (2013–2015), *Anal. Chem.* 88 (2016) 203–227.
- [2] Christophe Caucheteur, Tuan Guo, Jacques Albert, Review of Plasmonic Fiber optic biochemical sensors: improving the limit of detection, *Anal. Bioanal. Chem.* 407 (2015) 3883–3897.
- [3] Nibu A. George, Anu Maria Paul, M.S. Saranya, Microbend Fiber optic detection of continuously varying refractive index of chlorinated water, *Optik* 125 (2014) 301–303.
- [4] H.R.A. Rahim, N. Irawati, H.A. Rafaie, H. Ahmad, S.W. Harun, R.M. Nor, detection Of different concentrations Of uric acid using tapered silica optical sensor coated with zinc oxide (Zno), *Jurnal Teknologi* 74 (8) (2015) 55–58.
- [5] Ravi Kant, Rana Tabassum, Banshi D. Gupta, Fiber optic SPR based uric acid biosensor using uricase entrapped polyacrylamide gel, *IEEE* 28 (19) (2016) 2050–2053.
- [6] Rana Tabassum, Banshi D. Gupta, Fiber optic manganese ion using SPR nanocomposite of ZnO-polypyrrol, *Sens. Actuators B* 220 (2015) 903–909.
- [7] WuroodAbdulkhaleq Khaleel, AbdulHadiM. Al-Janabi, High-sensitivity sucrose erbium-doped fiber ring laser sensor, *Opt. Eng.* 56 (2) (2017) 026116.
- [8] Jiangtao Zhou, Yiping Wang, Changrui Liao, Sun Bing, Jun He, Guolu Yin, Shen Liu, Zhengyong Li, Guanjun Wang, Xiaoyong Zhong, Jing Zhao, Intensity modulated refractive index sensor based on optical fiber Michelson Interferometer, *Sens. Actuators B* 208 (2015) 315–319.
- [9] Gobi Govindan, Dillibabu Srinivasan Gokul Raj, Sastikumar, Measurement of refractive index of liquids using fiber optic displacement Sensors, *J. Am. Sci.* 5 (2) (2009) 13–17.
- [10] S. Binu, V.P. Mahadevan Pillai, V. Pradeepkumar, B.B. Padhy, C.S. Joseph, N. Chandrasekaran, Fibre optic glucose sensor, *Mater. Sci. Eng. C* 29 (2009) 183–186.

- [11] M. Yasin, S. Soelistono, Y.G. Yhun Yhuwana, M. Khasanah, H. Arof, N. Irawati, S.W. Harun, Intensity based optical fiber sensors for calcium detection, *J. Optoelectron. Adv. Mater.* 9 (9–10) (2015) 1185–1189.
- [12] HusnaAbdul Rahman, SulaimanWadi Harun, M. Yasin, Harith Ahmad, fiber-optic salinity sensor using fiber-optic displacement measurement with flat and concave mirror, *IEEE J. Sel. Top. Quant. Electron.* 18 (5) (2012) 1529–1533.
- [13] Samian, Y.H. Pramono, A.Y. Rohedi, F. Rusydi, A.H. Zaidan, Theoretical and experimental study of fiber-optic displacement sensor using multimode fiber coupler, *J. Optoelectron. Adv. Mater. Rapid Commun.* 3 (5) (2009) 411–414.
- [14] Samian, G.Y.Y. Yhosep, A.H. Zaidan, Herlik Wibowo, Gasoline level sensor based on displacement sensor using fiber coupler, *Measurement* 58 (2014) 342–348.
- [15] Samian, A.H. Zaidan, Moh. Yasin, Detection of Rhodamine B levels in distilled water based on displacement sensor using fiber coupler and concave mirror, *J. Optoelectron. Adv. Mater.* 18 (11–12) (2016) 988–992.
- [16] K.P. Schlingmann, M. Konrad, H.W. Seyberth, Genetics of hereditary disorders of magnesium Homeostasis, *Pediatr. Nephrol.* 19 (1) (2004) 13–15.

Detection of magnesium ion concentration using fiber coupler based displacement sensor with concave mirror target

ORIGINALITY REPORT

16%

SIMILARITY INDEX

8%

INTERNET SOURCES

14%

PUBLICATIONS

0%

STUDENT PAPERS

PRIMARY SOURCES

- 1 Rahman, Husna Abdul, Sulaiman Wadi Harun, Hamzah Arof, Ninik Irawati, Ismail Musirin, Fatimah Ibrahim, and Harith Ahmad. "Classification of reflected signals from cavitated tooth surfaces using an artificial intelligence technique incorporating a fiber optic displacement sensor", *Journal of Biomedical Optics*, 2014.

Publication

3%
- 2 M. Yasin. "Fiber optic chemical sensor using fiber coupler probe based on intensity modulation for alcohol detection", *Microwave and Optical Technology Letters*, 08/2011

Publication

1%
- 3 www.sensorsportal.com

Internet Source

1%
- 4 Harun, S.W., H.Z. Yang, H. Arof, and H. Ahmad. "Theoretical and experimental studies on coupler based fiber optic displacement sensor with concave mirror",

1%

Optik - International Journal for Light and Electron Optics, 2012.

Publication

5	doaj.org Internet Source	1 %
6	Y.G. Yhun Yhuwana, R. Apsari, M. Yasin. "Fiber optic sensor for heart rate detection", Optik - International Journal for Light and Electron Optics, 2017 Publication	1 %
7	www.chalcogen.infim.ro Internet Source	1 %
8	Samian, G.Y.Y. Yhosep, A.H. Zaidan, Herlik Wibowo. "Gasoline level sensor based on displacement sensor using fiber coupler", Measurement, 2014 Publication	1 %
9	oro.open.ac.uk Internet Source	1 %
10	P., Kishore, Dinakar D., Srimannarayana K., Vengal Rao P., Kemao Qian, and Anand Asundi. "A simple 1×2 plastic optical fiber coupler based vibration sensor", International Conference on Optics in Precision Engineering and Nanotechnology (icOPEN2013), 2013. Publication	1 %
11	Samian, Y.G.Y. Yhuwana, A.H. Zaidan, Supadi, Sujito. "Application of two-output	1 %

port fiber coupler as gasoline level sensor",
Measurement, 2016

Publication

12 H. H. M. Yusof, H. R. A. Rahim, S. Thokchom,
K. Dimiyati, S. W. Harun. "Uric acid sensing
using tapered silica optical fiber coated with
zinc oxide nanorods", Microwave and
Optical Technology Letters, 2018

Publication

13 Moh. Budiyanto, Suhariningsih, Moh. Yasin.
"Optical fiber displacement sensor using
concave mirror for cholesterol detection",
2017 International Seminar on Sensors,
Instrumentation, Measurement and
Metrology (ISSIMM), 2017

Publication

14 M. Yasin. "The performance of a fiber optic
displacement sensor for different types of
probes and targets", Laser Physics Letters,
01/2008

Publication

15 Samian Samian, Andi Zaidan, Moh Yasin,
Sujito Sujito. "Performance comparison of
liquid level sensors using fiber coupler and
fiber-bundled probe", Microwave and
Optical Technology Letters, 2018

Publication

16 Hang Zhou Yang, Xue Guang Qiao, Dong
Luo, Kok Sing Lim, WuYi Chong, Sulaiman
Wadi Harun. "A review of recent developed

and applications of plastic fiber optic displacement sensors", Measurement, 2014

Publication

17

Rahman, H. A., M. Yasin, S. W. Harun, and H. Ahmad. "A new fiber optic salinity sensing device based on beam-through technique", 2012 International Conference on Computer and Communication Engineering (ICCCE), 2012.

Publication

<1 %

18

Samian, A.H. Zaidan, Sujito, M. Yasin, M. Pujiyati, Supadi. "Liquid level sensor using two fiber bundles", Sensors and Actuators A: Physical, 2018

Publication

<1 %

19

Rahman, Husna Abdul, Sulaiman Wadi Harun, Norazlina Saidin, Moh. Yasin, and Harith Ahmad. "Fiber Optic Displacement Sensor for Temperature Measurement", IEEE Sensors Journal, 2012.

Publication

<1 %

20

Frank G. Harmon, Stephen C. Kowalczykowski. " Biochemical Characterization of the DNA Helicase Activity of the RecQ Helicase ", Journal of Biological Chemistry, 2001

Publication

<1 %

Exclude quotes Off

Exclude matches Off

Exclude bibliography On

Detection of magnesium ion concentration using fiber coupler based displacement sensor with concave mirror target

GRADEMARK REPORT

FINAL GRADE

/0

GENERAL COMMENTS

Instructor

PAGE 1

PAGE 2

PAGE 3

PAGE 4

PAGE 5

PAGE 6

PAGE 7
