

Analyze Activation Marker of Azurophilic Granule (CD63) and CFSE CD11C Expressions of Salivary Neutrophils Insevere Early Childhood Caries.

by Retno Indrawati.,drg

Submission date: 18-Jun-2018 09:27AM (UTC+0800)

Submission ID: 976498895

File name: ions_of_Salivary_Neutrophils_Insevere_Early_Chilhood_Caries..pdf (6.93M)

Word count: 62763

Character count: 332270



Institute of Tropical Disease
Universitas Airlangga

Institute for Protein Research
Osaka University

Molecular and Cellular Life Sciences: Infectious Diseases, Biochemistry and Structural Biology

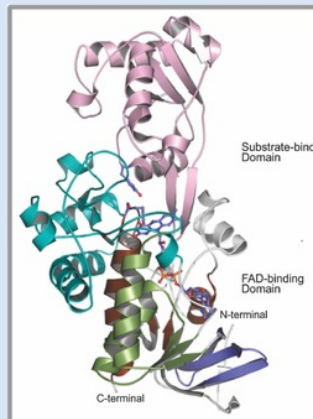
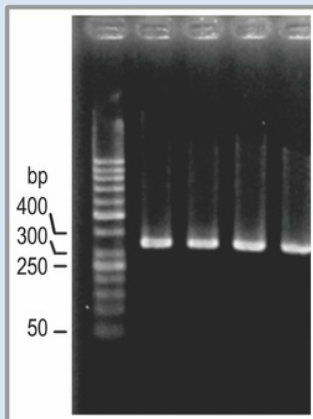
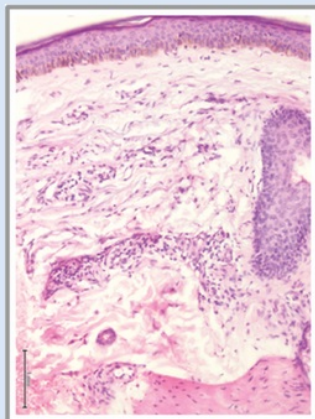

Editors:

Prof. Dr. Ni Nyoman Tri Puspaningsih
Prof. Dr. Maria Inge Lusida
Dr. Juniastuti
Dr. Mirny Lamid
Dr. Purkan
Ali Rohman

Molecular and Cellular Life Sciences (MCLS) Conference
Surabaya, 7 – 8 May 2015

Proceeding

Molecular and Cellular Life Sciences:
Infectious Diseases, Biochemistry and Structural Biology

Editors:

Prof. Dr. Ni Nyoman Tri Puspaningsih
Faculty of Sciences & Technology and Institute of Tropical Disease, Universitas Airlangga,
Indonesia

Prof. Dr. Maria Inge Lusida
Faculty of Medicine and Institute of Tropical Disease, Universitas Airlangga, Indonesia

Dr. Juniastuti
Faculty of Medicine and Institute of Tropical Disease, Universitas Airlangga, Indonesia

Dr. Mirny Lamid
Faculty of Veterinary Medicine, Universitas Airlangga, Indonesia

Dr. Purkan
Faculty of Sciences & Technology, Universitas Airlangga, Indonesia

Ali Rohman
Faculty of Sciences & Technology and Institute of Tropical Disease, Universitas Airlangga,
Indonesia

Guest Editors:

Prof. Toshiharu Hase
Institute for Protein Research, Osaka University, Japan

Prof. Bauke W. Dijkstra
Laboratory of Biophysical Chemistry, University of Groningen, Netherlands

Prof. Nicholas E. Dixon
School of Chemistry, Centre for Medical and Molecular Bioscience, University of Wollongong,
Australia

Prof. Genji Kurisu
Institute for Protein Research, Osaka University, Japan

Molecular and Cellular Life Sciences (MCLS) 2015 Conference
Surabaya, 7 – 8 May 2015

Copyright © The authors
Copyright © Institute of Tropical Disease, Universitas Airlangga

All rights reserved
ISBN 978-602-14292-4-2



Institute of Tropical
Disease
Universitas Airlangga

in a collaboration
with



Institute for Protein Research
Osaka University

Proceeding

Molecular and Cellular Life Sciences:
Infectious Diseases, Biochemistry and
Structural Biology
MCLS 2015

ISBN 978-602-14292-4-2

Preface

The International Seminar on Molecular and Cellular Life Sciences: Infectious Diseases, Biochemistry & Structural Biology (MCLS 2015) was held in Hotel Pullman Surabaya City Centre, Surabaya, Indonesia, on 7 – 8 May 2015. This seminar was organized by the Institute of Tropical Disease, Universitas Airlangga, Indonesia in a very productive collaboration with the Institute for Protein Research, Osaka University, Japan. The seminar program included plenary lectures, invited lectures, oral presentations, poster exhibition, as well as a welcome visit to the house of the Mayor of Surabaya. In total of 208 scientific participants, 14 of whom are invited speakers, contributed to this conference. During conference, they had very effective shares and discussions in the fields of infectious diseases, biochemistry, and structural biology. MCLS 2015 was indeed in a truly international atmosphere. The participants came from 9 different countries, *i.e.* Australia, Indonesia, Japan, Malaysia, Netherlands, Singapore, Thailand, Taiwan, and Vietnam.

In order to spread the seminar outcomes, I would like to introduce you a conference proceeding (Molecular and Cellular Life Sciences: Infectious Diseases, Biochemistry and Structural Biology, ISBN 978-602-14292-4-2. A total of 62 papers were submitted to MCLS 2015 and each paper was reviewed by three peers. Of these reviewed papers, 32% were selected to be published in this proceeding. My grateful thanks to you all the peer-reviewers, who are Prof. Toshiharu Hase (Osaka University, Japan), Prof. Bauke W. Dijkstra (University of Groningen, Netherlands), Prof. Nicholas E. Dixon (University of Wollongong, Australia), Prof. Genji Kurisu (Osaka University, Japan), Prof. Ni Nyoman Tri Puspaningsih (Universitas Airlangga, Indonesia), Prof. Maria Inge Lusida (Universitas Airlangga, Indonesia), Dr. Juniastuti (Universitas Airlangga, Indonesia), Dr. Mimy Lamid (Universitas Airlangga, Indonesia), Dr. Purkan (Universitas Airlangga, Indonesia), and Ali Rohman (Universitas Airlangga, Indonesia).

On behalf of the organizing committee, in this joyful moment I would like to express my sincere gratitude to Prof. Fasich (Rector of Universitas Airlangga), Prof. Saburo Aimoto (Executive Vice President of Osaka University), Prof. Dr. Nasronudin (Director of the Institute of Tropical Disease, Universitas Airlangga), Prof. Haruki Nakamura (Director of the Institute for Protein Research, Osaka University), and Prof. Toshiharu Hase (the Institute for Protein Research, Osaka University) who facilitated this event to be smoothly taken place. I would also like to thank all the invited speakers for their discussions and sharing. They are Prof. Toshiharu Hase (Osaka University, Japan), Prof. Bauke W. Dijkstra (University of Groningen, Netherlands), Prof. Nicholas E. Dixon (University of Wollongong, Australia), Prof. Genji Kurisu (Osaka University, Japan), Prof. James R. Ketudat Cairns (Suranaree University of Technology, Thailand), Prof. Chun-Jung Chen (National Synchrotron Radiation Research Center, Taiwan), Prof. Bambang Sugiharto (Jember University, Indonesia), Prof. Kiyoshi Kita (University of Tokyo, Japan), Prof. Eiji Konishi (Mahidol University, Thailand and Osaka University, Japan), Prof. Atsushi Nakagawa (Osaka University, Japan), Prof. Robert C. Robinson (The Agency for Science, Technology and Research (A*STAR), Singapore), Prof. Hitoshi Sakakibara (Nagoya University, Japan), Prof. Ni Nyoman Tri Puspaningsih (Universitas Airlangga, Indonesia), and Prof. Maria Inge Lusida (Universitas Airlangga, Indonesia). Moreover, I wish to convey my sincere appreciation to the Mayor of Surabaya Madam Dr. (H.C.) Tri Rismaharini for inviting our distinguished guests to a warm welcome dinner in her official residence. An event such this conference requires a lot of work from many people. Therefore, I take this opportunity to thank to the Organizing Committee of MCLS 2015 and all people who supported this conference in various ways.

Last but not least, we hope that this proceeding provides a valuable contribution for the development of science and technology, especially in the area of infectious diseases, biochemistry, and structural biology.

Sincerely yours,

Maria Inge Lusida

Chairperson of the Organizing Committee

Scientific Committee of MCLS 2015

Prof. Toshiharu Hase

Institute for Protein Research, Osaka University, Japan

Prof. Bauke W. Dijkstra

Laboratory of Biophysical Chemistry, University of Groningen, Netherlands

Prof. Nicholas E. Dixon

School of Chemistry, Centre for Medical and Molecular Bioscience, University of Wollongong, Australia

Prof. Genji Kurisu

Institute for Protein Research, Osaka University, Japan

Prof. Ni Nyoman Tri Puspaningsih

Faculty of Sciences & Technology and Institute of Tropical Disease, Universitas Airlangga, Indonesia

Prof. Maria Inge Lusida

Faculty of Medicine and Institute of Tropical Disease, Universitas Airlangga, Indonesia

Dr. Juniastuti

Faculty of Medicine and Institute of Tropical Disease, Universitas Airlangga, Indonesia

Dr. Mirny Lamid

Faculty of Veterinary Medicine, Universitas Airlangga, Indonesia

Dr. Purkan

Faculty of Sciences & Technology, Universitas Airlangga, Indonesia

Ali Rohman

Faculty of Sciences & Technology and Institute of Tropical Disease, Universitas Airlangga, Indonesia



Institute of Tropical
Disease
Universitas Airlangga

in a collaboration
with



Institute for Protein Research
Osaka University

Proceeding

Molecular and Cellular Life Sciences:
Infectious Diseases, Biochemistry and
Structural Biology
MCLS 2015

ISBN 978-602-14292-4-2

Contents

	Page
Cover	i
Preface	iii
Contents	v
HIV-1 Mutations Associated to RT Inhibitor Were Identified On Drug Naive and Arv Treated Subjects In Jayapura	1
Hotma Martogi Lorensi Hutapea	
Total Lymphocytes and Basophiles Blood Count in Chicken after Being Infected with <i>Newcastle Disease</i> Antigen (Early Study on the Potency of <i>Curcuma domestica val</i> as Immunostimulator Candidate)	6
Nurul Hidayah	
In the case of an emphysematous lung, could MMP-9 activity of gingival crevicular fluid substitute that of the sputum?	11
Mulkan Azhary	
Cloning and expression of cDNA encoding membrane protein of tachyzoite of <i>Toxoplasma gondii</i> local isolate in bacteriophage	15
Mufasirin	
Contribution Bioactive Flavan-3-ol Callus <i>Camellia sinensis</i> as a Candidate Healing Diarrhea Disease	24
Sutini	
In Vitro Antimalarial Activity of Ethanol and Methanol Extract <i>Carthamus tinctorius</i> L	30
Rini Hamsidi	
Vanillin Production from Lignocellulosic Extract of Oil Palm Empty Fruit Bunch Fiber (OPEFBF) by <i>Pycnoporus cinnabarinus</i>	34
Tang Pei-Ling	
A High Prevalence of Oral Manifestation and Their Profile Among HIV/AIDS Patients at UPIPI RSUD Dr. Soetomo Surabaya 2014	38
Bagus Soebadi	
Isolation of Duck Ceca Bacteria as Probiotics to Prevent Salmonellosis	44
Mohammad Anam Al-Arif	
Predominant Genotype of Hepatitis B Virus in HBsAg Positives Patient on Maintenance Hemodialysis, in Surabaya, Indonesia	48
Retno Handajani	

The Prevalence of Anti-Hepatitis C Virus (anti-HCV) Antibody among Blood Donors in Tuban, East Java, Indonesia	51
Supiana Dian Nurtjahyani	
Analyze Activation Marker of Azurophilic Granule (CD63) And CFSECD11C Expressions of Salivary Neutrophils in Severe Early Childhood Caries	54
Muhammad Luthfi	
Insilico Docking Analysis Of <i>Imperata Cylindrica</i> Pure Compound And Human Thymidylate Synthetase Mutant As Choriocarcinoma Anti Cancer Candidate	61
Reza Arta Bagaskoro Nugroho	
Loewe additivity analysis to find synergism ratio doxorubicin and quercetin	66
Abdul Khairul Rizki Purba	
Preventive Effect of <i>Marsilea crenata</i> Leaves and Stalks Juice Againts Urolithiasis in Rats (<i>Rattus norvegicus Wistar Strain</i>)	73
Sri Murwani	
Pathogenecity and molecular studies of zoonotic disease caused <i>Edwardsiella tarda</i>	79
Kurniasih	
Biological Toxicity and Identification of Extract of n-Hexane, Chloroform, Ethyl Acetate and Ethanol from <i>Chlorella pyrenoidosa</i> Against Larvae of <i>Artemia salina</i>	83
Ni Wayan Sri Agustini	
Beta Glucan From <i>Saccharomyces Cerevisiae</i> Derived From The Local Ragi And Its Potential As Antioxidants	89
Kusmiati	
Anti-tuberculosis activity of chloroform and methanol extracts of <i>Michelia champaca</i> L. stem bark against <i>Mycobacterium tuberculosis</i> MDR	97
Ni Putu Ariantari	
Determination of free Prostate of Specific Antigen (fPSA) in Normal Patients Using The Immunoradiometricassay (IRMA) PSA Kit Developed in Center for Radioisotopes and Radiopharmaceuticals Technology National Nuclear Energy Agency	100
Puji Widayati	



Institute of Tropical
Disease
Universitas Airlangga

in a collaboration
with



Institute for Protein Research
Osaka University

Proceeding

Molecular and Cellular Life Sciences:
Infectious Diseases, Biochemistry and
Structural Biology
MCLS 2015

ISBN 978-602-14292-4-2

HIV-1 Mutations Associated to RT Inhibitor Were Identified On Drug Naive and Arv Treated Subjects In Jayapura

Hotma Martogi Lorensi Hutapea^{a*}, Mima Widiyanti^a, Try Nury Kridaningsih^a,
Eva Fitriana^a

^aBalai Litbang Biomedis Papua Jln. Kesehatan No.10 Dok II Jayapura

Abstract

Human Immunodeficiency Virus (HIV) type 1 cases in Papua province has categorized as high. The high incidence of HIV can be the result of ineffective antiretroviral (arv) therapy in patients. Ineffectiveness of ARV treatment might be the result of mutation that causes the virus to become resistant to a given arv. The objective of this study was to identify mutations associated with HIV against arv Reverse Transcriptase Inhibitors (RTI) group. The study was applied to 50 plasma samples of both arv naive and arv treated subjects. The 500 µl of each plasma sample was precipitated by centrifugating 14,000 rpm for 1 hour at 4°C. RNA was extracted from the precipitated pellet using membrane filtration technique. Each RNA was converted into cDNA by using One-Step RT-PCR kit and incubated at 50°C for 30 min, and 95°C for 15 minutes. Amplification of DNA fragment encoding Reverse Transcriptase (RT) was performed using PCR technique with the program 95°C, 4 minutes, 35x (95°C, 1 min; 53°C, 1 min; 72°C, 1 min); 72°C, 7 min. PCR products were purified and then characterized by migration analysis and sequencing. Sequencing results showed 5 samples were identified as mutants, 3 out of 5 were associated to RTI that occurred in subjects who were treated with ARV, 1 polymorphism in drug naive subject samples, and 1 RT inhibitor resistance-associated mutation in drug naive subject.

Keywords: Drug Resistance; HIV-1; Mutation

1. Introduction

The invention of antiretroviral (arv) has increased the expectation of Human Immunodeficiency Virus type 1 (HIV-1) infection eradication. The arv has been given to decrease the viral load in human CD4 cells. That makes arv as the primer choice to treat people living with HIV/AIDS. One of several arv group which is used in therapy program is Reverse Transcriptase Inhibitor (RTI). RTI basically works by inhibiting the activity of Reverse Transcriptase (RT) in viral multiplication. This therapy has been conducted as the first line therapy program in Jayapura. The decretion of HIV replication in blood has to be sustainable so that the patient can experience the immune system recovery. The recovery can be obtained by the patients with good adherence during the arv therapy. The patients' adherence is important to reduce the resistancy level of HIV-1 to the arv, and to prevent the transmission of HIV-1 mutant strain. The arv therapy is given as an arv combination to reduce the possibility of viral drug resistancy. Virus resistancy to arv occur because of the particular point mutation on viral DNA that change the sequence of amino acid of protein¹. The arv therapy conducted to the patient in Clinic of Care, Support, and Therapy (CST) in Jayapura are the combination of nucleotide analog, Lamivudine (3TC)+Tenofovir Disoproxil Fumarate (TDF), Zidovudine (AZT)+3TC+ nonnucleoside analog Nevirapin (NVP) or Efavirenz (EFV).

Mutation is the alternation of DNA in the gene on chromosome and can be passed down to next generation. The mutation associated to drug resistancy can change the DNA sequence of the targeted pathogen so it will not be recognized by the drug. The mutations associated to NRTI resistancy are M41L, E44A/D, A62/V, K65R, D67N, T69D/G/N, T69 insertions, K70R, L74V, V75I/A/M/S/T, Y115F, F116Y, V118I, Q151M, M184V/I,

* Corresponding author. Tel.: -; fax: -.
E-mail address: hotmahutapea@gmail.com

L210W, T215F/Y, and K219Q/N/E and mutation associated to NNRTI resistancy is A98G, L100I, K101E/Q, K103N, V106A/I, V108I, V179D/E, Y181C/I, Y188L/C/H, G190A/S/T, P225H, M230L, and P236L^{2,3}.

Mutations that often occur in people living with HIV/AIDS are selective mutations resulting from 3TC exposure. The mutation altered the methionine at codon position 184 changed into valine (M184V). Such changes lead to the decretion of viral susceptibility to 3TC. The therapy using 3TC also limit the use of arv drugs from the same group in the future. Miller *et al* in 1998 who conducted a study about resistancy of HIV against 3TC showed that mutations that cause HIV resistance to 3TC also trigger HIV resistance to abacavir, emtricitabine, and didanosine¹.

Another research study concerning to mutation associated to resistancy was conducted by Bansode in Karonga District, Malawi on 2011 showed the high level of mutation associated to RTI. There were 15 out of 75 individuals were identified carrying drug resistant HIV variants. The resistances was associated to mutation occur in codon number 118 where valin was changed in to isoleucine to form V118I motive. Another mutation is Y181C and G190A/E, K103K/N, Y181N/Y, V190I/V, dan H221H/Y². Based on drug resistance database Stanford, G190A mutation causes a high level of resistance against EFV.

The database of the Stanford HIV drug resistance showed that resistance to TDF-associated mutations are K65R, Y115F, M41L, K70R, L210W, T215Y/F, T69 insertions, Q151M⁴. Based on research conducted by Wainberg in 1998, K65R motif occurs selectively when the HIV-1 cultured together with various concentration of TDF⁵. Another study done by the Rhee in 2006 showed that the presence of K65R lowering efficacy of TDF approximately 2 times when measured using the test PhenoSense⁶.

This study focuses on arv resistance associated mutations identified in the DNA of HIV rt region by referring the nucleotide sequences to previous research data that has been published. HIV resistance testing against RTI was not conducted either in vitro or in vivo. The mutation data of HIV rt obtained from this study was able to describe whether the combination of arv used in CST in Jayapura still effective for this study subject.

2. Method

2.1. Study Subjects

The clinical isolate of this study included the arv naive patients (13 subjects) and the RTI group arv exposed patients (37 subjects).

2.2. Design of PCR primers

The rHIV-1 gene sequences were collected from genbank. The sequences were: HIV-1 subtype A (AB052995.1), subtype B (AY180905.1), subtype C (AY162225.1), subtype D (AY322187.1), subtype E (AB052995.1), and subtype CRF01_AE (AY167123.1). The collected gene sequences were aligned using clustal W2 EMBL-ABI and primer design was focused on the most conserved region on nucleotide 30 to 700. A pair of primer was designed manually at 1839-2569 in full genome and was confirmed by using BLAST on <http://ncbi.nlm.nih.gov>.

2.3. HIV-1 RNA extraction

The five hundreds microliter blood plasma was prepared by precipitating the viral through centrifugation at 14,000 rpm, 4°C for 1 hour. Viral RNA was extracted from blood plasma according to QiaAmp Viral RNA Extraction Minikit (Qiagen) with modification in elution step. The elution of RNA was performed by applying preheated AVL buffer.

2.4. Amplification rHIV-1 region by PCR

Prior to amplification step of rt of HIV-1 region, viral RNA was reverse transcribed using a pair of specific primer which was designed for this research to obtain specific cDNA. Synthesis of cDNA was performed in a total volume 25 µl containing 5xRT-PCR buffer, 10 uM dNTP, 0.5 uM pRTHIVF, 0.5 uM pRTHIVR, 200 ng RNA template, and 1 µl of SSIII-Platinum Taq Polymerase enzyme mix (Invitrogen). The reaction was performed by incubating the tube at 50°C for 30 minutes, and 95°C for 15 minutes to inactivate the SSIII enzyme. PCR amplification from cDNA as the template was performed in a total volume 50 µl containing 25 µl reverse transcription reaction, and 25 µl green PCR ready mix (Thermoscientific). Denaturation step was performed at 95°C followed by 35 cycles of (95°C; 57°C; 72°C). The final elongation was performed at 72°C. PCR product was characterized on agarose gel 1%.

2.5. Mutation analysis

PCR product was purified from agarose gel and sequenced. The sequencing was performed using ABI technology. Sequencing result was analyzed by assaying the homology of the product to the data from genbank. DNA fragment confirmed as rHIV was proceeded into mutation analysis using application on <http://hivdb.stanford.edu>. Every sample identified as mutant associated to resistance was referred back to the peak of chromatogram to assure the mutation.

3. Results

3.1. The rHIV-1 from isolates were successfully amplified using the designed primer

Among the 50 samples sequenced, 5 samples were identified as mutant (table 1). Mutation M184V and Y115F were identified on 2 samples. Mutan K70R was identified on 1 sample who receive arv combination D4T and EFV.

Table 1 Mutation motive in sample subjects.

Sample code	Sex	Age (years old)	ARV/ Length of Therapy	Mutation Motive	Resistancies status
601229	P	26	TDF, 3TC / 6 months	Y115F, M184V	TDF: intermediate 3TC: high level
601243	P	23	Duvi (AZT+3TC), NPV / 3 months	K70R	AZT:intermediate 3TC: susceptible NPV: susceptible
601250	L	56	Duvi (AZT+3TC), NPV/ 2 years	Y115F, M184V	AZT: susceptible 3TC: high level NPV: susceptible
601253	P	30	-	M41L, D67E	Low level resistancies to ABC, AZT, D4T, DDI, TDF
601264	L	27	-	V106I	Polymorphisme

A pair of primer was manually designed to anneal specifically to DNA fragment encoded for rHIV-1 at nucleotide (nt) 1839-2569 on HIV-1 complete genome. The expected PCR product was 730 base pair (bp). The sequence of primer is Prthivf 5'-TGTACAGAGATGGAAAAGGAAGGGAA-3' and Prthivr³⁸⁵-CCTCTAAGGAGTTTACATAATT GCCTTA-3'. The primer was confirmed by aligning the sequence on Basic Local Alignment Search Tool (BLAST) on website <http://www.ncbi.nlm.nih.gov>.

Mutation motive Y115F was identified on 2 subject samples together with M184V mutant. According to the study conducted by Sarafianos *et al.*, on 1999, M184V mutation related to viral resistancy to 3TC. It is associated with the substitution of isoleucine for methionine at position of 184 of HIV-1 RT which results from single base change. The M184I is rapidly replaced by the variant M184V during 3TC therapy⁹. The combination of Y115F mutation with M184V increasing the HIV-1 resistance to 3TC, but still susceptible to AZT and D4T. K70R mutation was identified once in 1 subject sample receiving Duviral and Nevirapine. Duviral is antiretroviral that contains AZT and 3TC. The K70R mutation was associated to intermediate resistance to AZT.

Another mutation also identified in 2 RT inhibitors naive subjects. One of the subject carrying mutation associated to low resistance level to several types of NRTI, but still susceptible to 3TC, FTC, and also NNRTI antiretroviral group. Another naive subject carried nucleotide polymorphisme V106I which is not associated to any drug resistancies.

4. Discussion

HIV-1 replication is prone to error and it causes genetic variation. Viral genetik variation is important to help in escaping from host immune system, and also in distribution of the drug resistance variant. There are 3 stages in viral life cycle where mutation can occur : 1) in dividing infected host cell, the genomic proviral of the virus is copied by DNA replication system of the host cells. 2) at the time viruses are produced by infected cell, viral genomic RNA is made by RNA polymerase of the host cell. 3) when virus infects the host cell, RT converts viral RNA genome into DNA. Approximately, the error level in those process relatively high, about 10^{-4} error each base in 1 replication cycle. The highly variant of HIV-1 sequences occurs not only in individual virus but also in the infected subject. The variation of the viral in the patient showed that one individual can be infected only by 1 virus, this explained that the viral sequences variation is generally occurred after the cell is infected. Though the main explanation of high viral diversity is because the amount of the infected cells, and the high rate of infected cell turn over, the mutation that occur during the viral life cycle is the main source of viral variation^{3,8}.

Reverse Transcriptase (RT) is viral essential component for replication which its activity is an etiological agent of Acquired Immunodeficiency Syndrome, AIDS. RT enzyme consists of 3 catalytic sites essential for converting viral genomic RNA into cDNA. However, RT is a polymerase with the lowest accuracy. Accuracy test conducted on 3 RT recombinant enzymes showed that lowest accuracy level identified on RT from HIV-1, 1 nucleotide per 1700 incorporated nucleotide, while the most accurate RT is from Moloney Leukemia Virus (MLV), 1 nucleotide per 30,000 incorporated⁹.

This study described the presence of mutation identified in subject sample. The subject of this study is HIV patient receiving arv and RTI naive patient as well. The arv given to the patient is combination of TDF+3TC+EFV, TDF+3TC+NVP, D4T+TDF, and D4T+EFV. Therapy of infected HIV patients was conducted by giving 2 or 3 arv combination to decrease the mutation rate associated to arv resistancies. Arv contribution to decrease the viral load in patient blod is significantly increase the HIV-1 infected patient's health and quality of life. RT is an ideal target in designing arv. The incomplete reverse transcription step which is facilitated by RT, the preintegration complex will not be formed and the virus will fail to replicate. Good adherence in therapy will help arv to repress the viral load in years, but will not be totally eliminated.⁴

The identification result showed that 5 subjects carried M184I which is substitution type of mutation. This mutation involve the enhanced differentiation mechanism in determining the normal dNTP from analogue nucleotide when NRTI-TP incorporated. The RT choose not to incorporate 3TC and FTC by steric hindrance^{5,6}. M184V mutation selectively occur in HIV-1 exposed to 3TC. The study conducted by Petrella on 2004 showed that substitution type of mutation occurred in cultured wild type HIV-1 as the concentration of 3TC was increased. M184V mutation was also related to several RT function alteration in vitro that altered the replication capacity⁷. M184V mutation decreases the viral susceptibility to ABC 2-3 fold, and more to 3TC in vitro^{10,11}. M184V mutation is not related to viral response to ABC significantly^{12,13}. However, M184V that arises with another analog thymidine mutant M41L, D67N, K70R, L210W, T215F/Y, and K219Q/E increasing the viral susceptibility to AZT¹⁴.

Mutation in position amino acid 115 was identified in 2 subject samples. Position 115 in RT domain is part of dNTP binding. Mutation occurs in this domain associated to viral resistancies to ABC and TDF, but increasing the RT accuracy. In lentivirus group, amino acid number 115 in RT is tyrosine (Y), whileas in another retroviral is phenylalanine. In HIV-1, Y115F mutation associated to low resistant level to nucleotide analogue. The conversion from Y into F in amino acid 115 causes the deletion of hydroxyl group. The RT error rate at Y115F is 1.0×10^{-4} , lower than wild type RT¹⁵.

Motive K70R mutation was identified on 1 subject sample exposed to AZT and 3TC combination and EFV for 3 months. The mutation is thymidine analogue mutant and associated to resistancies to AZT, ABC, d4T, and DDI. AZT is one of the analogue thymidine arv. It works by inhibiting the DNA rt chain formation specifically, leading to the failure of RT synthesis¹⁶. In a very high dose, AZT is able to inhibit the human cell DNA polymerase in cell binary division stage, but unlike in viral replication system, human cell has the ability in DNA repairing¹⁷. In this study, it was unknown whether the mutation identified in the subject sample was selected by arv or transmitted from the other patient.

In the RT inhibitor naive subjects, there were 2 HIV-1 infected subject identified as drug resistance related mutant and polymorphism carrier respectively. The mutation associated to drug resistancies were identified was more frequent identified in subject receiving arv. Another mutation, M41L motive known as the result of thymidine analogue arv therapy. It reduces the viral susceptibility to all approved NRTI. On this study, M41L mutant was detected on naive subject following mutant D67E.

Nucleotide sequences on HIV-1 that causes the changes of amino acid may occur naturally on untreated patients. Polymorphic can be identified in whole HIV-1 genome, even in the arv targeted gene. In this study, a V106I polymorphic mutant was identified in one sample subject. This V106I polymorphic mutant is unable to alter the viral RT response to arv. A study conducted by Gatanaga on 2010 revealed that V106I polymorphic mutant combine with V179D might alter the viral susceptibility to EFV and NVP significantly¹⁸.

Mutation associated to resistancies was also identified on an arv untreated non B subtype sample subject. It was assumed that virus carrying mutation associated to resistancies had a lower transmission level compared to the wild type virus. However, the current publication showed that 10.4% out of 2208 HIV-1 infected patients studied on a research conducted by Wensing on 2005 in 19 European countries was infected by more than 1 point mutation mutant. Most of the infection was subtype B originated from Europe and North America. Infected non subtype B HIV-1 infected arying drug resistant associated mutant was 4.8%¹⁹.

RT-HIV-1 must be able to complete the viral cDNA synthesis so it can be replicated and transmitted. Whileas the NRTI resistant RT has to maintain its ability to incorporate dNTP normally and efficiently by differentiating the normal nucleotide from NRTI. Mutation associated to arv resistancies has been a big challenge on HIV-1 eradication program. These mutants are transmitted and increasing the prevalence of resistant HIV on naive HIV-1 infected patients.

5. Conclusion

HIV-1 mutant associated to arv resistance has been identified in HIV-1 infected subject in Jayapura. However, the treatment by using the same arv combination can repress the HIV-1 multiplication.

Acknowledgement

The Authors gratefully acknowledge the CST clinic in Jayapura Hospital.

Reference

1. Miller V, Martin S, Schlomo S, Bettina G. The M184V Mutation in HIV-1 Reverse Transcriptase (RT) Conferring Lamivudine Resistance Does Not Result in Broad Cross-Resistance to Nucleoside Analogue RT Inhibitors. *AIDS* 1998, 12: 705 – 712.
2. Bansode VB, Simon AAT, Amelia CC, Bagrey N. Reverse Transcriptase Drug Resistance Mutations in HIV-1 Subtype C Infected Patients on ART in Karonga District, Malawi. *AIDS Research and Therapy* 2011, 8:38.
3. Hu, W.S., Hughes, S.H., 2012. HIV-1 Reverse Transcription. *Cold Spring Harb Perspect Med* 2012 (2) : a006882.
4. Arts, J.E. and D.J. Hazuda. HIV-1 Antiretroviral Drug Therapy. *csHPerspect*.a007161.
5. Kohlstaedt LA, Wang J, Friedman JM, Rice PA, Steitz TA. Crystal structure at 3.5 Å resolution of HIV-1 reverse transcriptase complexed with an inhibitor. *Science* 256:1783–1790.
6. Ding J, Das K, Hsiou Y, Sarafianos SG, Clark AD Jr, Jacobo-Molina A, Tantillo C, Hughes SH, Arnold E. Structure and functional implications of the polymerase active site region in a complex of HIV-1 RT with a double-stranded DNA template-primer and an antibody Fab fragment at 2.8 Å resolution. *J Mol Biol* 1998;284:1095–1111.
7. Keele BF, Elena E, Giorgi JF, Salazar G, Julie MD. Identification and Characterization of Transmitted and Early Founder Virus Envelopes in Primary HIV-1 Infection. *PNAS* 105 (21): 7552-7557.
8. Roberts, JD, K. Bebenek, Kunkel, T.A. The Accuracy of Reverse Transcriptase From HIV-1. *Science* 242 (4882): 1171-1173.
9. Sarafianos SG, Kalyan D, Arthur DC JR., Jianping D, Paul LB, Stephen HH, Edward A. 1999. Lamivudine (3TC) resistance in HIV-1 reverse transcriptase involves steric hindrance with β-branched amino acids. *Proc. Natl. Acad. Sci. USA* Vol. 96, pp. 10027–10032.
10. Petrella, M., Maureen O, Daniela M, M. Deterio. Differential Maintenance of the M184V Substitution in the Reverse Transcriptase of Human Immunodeficiency Virus Type 1 by Various Nucleoside Antiretroviral Agents in Tissue Culture. *ASM*, 48 No. 11 4189–4194.
11. Tisdale M, Kemp SD, Parry NR, Larder B. Rapid in vitro selection of human immunodeficiency virus type 1 resistant to 3'-thiacytidine inhibitors due to a mutation in the YMDD region of reverse transcriptase. *Proc Natl Acad Sci U S A*. 1993, 90(12):5653–5656.
12. Lanier, E. R., S. Glenn, M. Daniel, B. Stephen. HIV-1 reverse transcriptase sequence in plasma and cerebrospinal fluid of patients with AIDS dementia complex treated with Abacavir. *AIDS* 2001, 15 (6): 747 – 751.
13. Stone C., M. Ait-Khaled, C. C. P. Griffin, Tisdale, M. Human Immunodeficiency Virus Type 1 Reverse Transcriptase Mutation Selection during In Vitro Exposure to Tenofovir Alone or Combined with Abacavir or Lamivudine. *AMC* 2004, 48(4): 1413 – 1415.
14. Clavel, F., and A. Hance. HIV Drug Resistance. *N Engl J Med* 2004(350):1023 - 1035.
15. Boyer, P.L., Hughes, S.H. Effects of Amino Acid Substitutions at Position 115 on the Fidelity of Human Immunodeficiency Virus Type 1 Reverse Transcriptase. *J. Virol.* 2000, 74(14):6494-6500.
16. Khairunisa, SQ, T. Kotaki, A.M. Witaningrum, M.Q Yunifiar., *et al.* Appearance of Drug Resistance-Associated Mutation in Human Immunodeficiency Virus Type 1 Protease and Reverse Transcriptase Derived from Drug-Treated Indonesian Patients. *AIDS Res. Hum. Retroviruses*. 2014. (30), doi:10.1089/aid.2014.0221.
17. Mitsuya H, Weinhold K, Furman P, St Clair M, Li, Lars, Lehrman S, Gallo R, Bolognesi D, Barry D, Broder S. 3'-Azido-3'-deoxythymidine (BW A509U): an antiviral agent that inhibits the infectivity and cytopathic effect of human T-lymphotropic virus type III/lymphadenopathy-associated virus in vitro. *Proc Natl Acad Sci USA* 1985. 82 (20): 7096–100.
18. Gatanaga H., H. Ode, A. Hachiya, T. Hayashida. Efavirenz and Nevirapine but Not Etravirine Transcriptase Confers Resistance to Immunodeficiency Virus Type 1 Reverse Polymorphic Mutations in Human. *Antimicrob. Agents Chemother.*, 2010. 54(4):1596 – 1602.
19. Wensing, A.M.J., D. A. van de Vijver, Giocchino A., Birgitta A. Prevalence of Drug Resistant HIV-1 Variants in Untreated Individuals in Europe: Implications for Clinical Management. *JID* 2005. 192: 958-966.



Institute of Tropical
Disease
Universitas Airlangga

in a collaboration
with



Institute for Protein Research
Osaka University

Proceeding

Molecular and Cellular Life Sciences:
Infectious Diseases, Biochemistry and
Structural Biology
MCLS 2015

ISBN 978-602-14292-4-2

Total Lymphocytes and Basophiles Blood Count in Chicken after Being Infected with *Newcastle Disease Antigen* (Early Study on The Potency of *Curcuma domestica val* as Immunostimulator Candidate)

Nurul Hidayah^{a*}, Dyah Widhowati^b, Retina Yunani^c, Andri Prio Resmijai^d

^aDepartment of Microbiology and Virology, Veterinary Medicine Faculty, Wijaya Kusuma Surabaya University (UWKS), Surabaya 60255, Indonesia

^bDepartment of Microbiology and Virology, Veterinary Medicine Faculty, Wijaya Kusuma Surabaya University (UWKS), Surabaya 60255, Indonesia

^cDepartment of Pharmacology, Veterinary Medicine Faculty, Wijaya Kusuma University, Surabaya 60255, Indonesia

^dStudent of Veterinary Medicine Faculty, Wijaya Kusuma University, Surabaya 60255, Indonesia

27

Abstract

The aim of this research was to observe total lymphocytes and basophiles in chicken after has been administered with *Curcuma domestica val* (*Cdv*) and infected with *Newcastle disease Antigen* (*NDA*). The research was performed to forty chicken which were divided into four groups. Group 1 received drinking water, group 2 received drinking water + 40% *Cdv* twice a day for 2 weeks, group 3 received drinking water + 50% *Cdv* and group 4 received drinking water + 60% *Cdv*. They were infected with *NDA* after 2 weeks and total lymphocytes and blood basophiles were counted. The research showed that 40% *Cdv* increased total lymphocytes and total basophiles.

Keywords: Lymphocytes; basophiles; Newcastle disease; immunostimulator; *Curcuma domestica*

Nomenclature

NDA Newcastle Disease Antigen
Cdv *Curcuma domestica val*

1. Introduction

Newcastle Disease (ND) is an acute and easily transmitted respiratory disease. The disease is caused by a virus that attacks poultry, especially chickens, and causes significant loss to poultry economy. This is because its morbidity and mortality rates are high. Up to 100% of ND infects poultry farms^{2,3}.

ND disease outbreaks often occur in groups of chickens that do not have immunity or a group that has low immunity due to late vaccination or because of the failure of the vaccination program. In other countries, such as in China, poultry farms have already applied immunomodulator prior to vaccination. It is intended to be able to raise or increase the immune response prior to vaccination because it is expected to provide immunity against diseases like ND.

Immunomodulator is a compound that can increase the body's defense mechanisms both specific and non-specific. Compounds that have a fairly good prospect to increase the activity of the immune system are usually of the flavonoid, curcumin, limonoids, vitamin C, vitamin E (tocopherol) and catechins. Results of in vitro test of the flavonoid class of flavones and flavonols have been shown to increase immune response⁵. One of the

cc

* Corresponding author Tel.: +62 857 3290 8167; fax: +62 031 5679791.
E-mail address: ululsantoso@gmail.com

medicinal plants that can be used as an immunomodulator is turmeric. Several studies on the content of bioactive compounds in turmeric plant showed that turmeric contains curcumin compounds, demetoxykurkumin, bisdemetoxykurkumin and essential oils. This is supported by Napirah *et al.*⁸, who found that the administration of turmeric powder in quail broilers feed showed immunomodulator activity ie as reflected in the increase of total leukocyte count, neutrophyl, lymphocytes, basophils and monocytes percentage.

Assessment of turmeric use as an immunomodulator in broilers in Indonesia is remains rare. Therefore, more studies regarding the application of turmeric as an immunomodulator are needed. This aim of this research was to prove the effect of turmeric on the number of basophils in broilers infected with Newcastle Disease (ND) antigen that causes Newcastle Disease (ND).

2. Methods

This research used experimental animals comprising 40 Day Old Chick (DOC) broiler obtained from PT. Charoen Pokphan. Materials used in this study were turmeric juice, and Newcastle Disease (ND) antigen (derived from PUSVETMA, Surabaya), 10% Giemsa solution, methanol, water, and commercial broiler chicken feed. Equipments used in the study included henhouse, food and drink container, 1 ml syringe, EDTA tube, glass objects, capillary pipette, and a light microscope for observation.

2.1. Sampling Techniques

Blood sampling was carried out once the DOC arrived. As many as four samples of blood were taken, and the volume taken from each sample was maximally 1 ml. DOC blood sampling was done through wing veins, and the blood was collected in EDTA tubes to prevent blood clotting. After rearing for seven days, chicken blood sample was taken again through the brachial vein and then the blood was collected in EDTA tubes to prevent blood clotting. Three days after being infected with Newcastle Disease (ND) antigen, chicken blood sample was taken again through the brachial vein and then the blood was collected in EDTA tubes to prevent blood clotting. Basophil counting was done in the Laboratory of Microbiology, Faculty of Veterinary Medicine, Wijaya Kusuma Surabaya University.

2.2. Research Procedure

Forty samples, two-week old chicken, were placed in experimental unit with ad libitum supply of food and water. The chicken were randomly divided into four groups, each of 10 chicken ($n = 10$). Group 1 (P0) served as control group, receiving drinking water without *Curcuma domestica val.* Group 2 (P1), group 3 (P2), and group 4 (P3) served as treatment groups I, II, and III. These groups received drinking water of respectively 40%, 50% and 60% *Curcuma domestica val* twice a day for 2 weeks and, thereafter, they were infected with Newcastle disease virus.

The drinking water was given with turmeric extract once daily in the morning and after that the chicken were given with regular drinking water. The research was carried out until the chicken were about 2 weeks old. Exposure to Newcastle Disease (ND) antigen was done intramuscularly or through drinking water to the three-day old chicken treatment group. Blood sampling was performed 3 times, first when the chicken (DOC) arrived, 7 days after the administration of turmeric juice in drinking water, and 3 days after the chicken were infected with Newcastle Disease (ND) antigen. Furthermore, the blood sample was taken to the laboratory to quantify basophil count.

Basophil counting was performed using blood smear preparation and stained with 10% Giemsa for 30 minutes. The blood sample was mixed homogeneously before it was taken with capillary pipette. Then, a small drop of blood was placed near the end of the object glass at the flat surface. The second object glass was placed with the tip touching the glass surface of the first objects glass forming an angle of 30-45°. The second object glass was pulled aside and allowed the blood to flow by capillary power to achieve the first 2/3 object area. Both object glasses were driven by the same angle so as to form a thin layer. Blood smear preparations were left to dry in open air.

Blood smear preparations were fixed with methyl alcohol for 3-5 minutes. Preparations were taken and allowed to dry in the air. Once dried, the preparations were soaked with Giemsa dye for 15-60 minutes. The mixture was washed with water several times and allowed to dry in a rack. Calculation of basophils percentage was conducted with an objective magnification of 100x, basophil classification was done in some fields of view and counted per 100 leukocytes. At the end of the experiment, the blood was collected intrabradially, and the lymphocytes and basophiles were counted.

3. Result and discussion

After performing research on the effect of turmeric juice (*Curcuma domestica Val.*) on the number of basophils in broilers infected with Newcastle Disease (ND) antigen, the result can be seen in some of the following tables and will be further described in the section below.

3.1. Total Lymphocytes

Table 1 Average and Standard Deviation ($\bar{X} \pm St. D$) of Total Lymphocyte (/mm³)

Treatment	Aged	$\bar{X} \pm St. D$
P0	0	(42150.40 ± 8545.57) ^{a,a}
	7	(81548.80 ± 25762.71) ^{a,b}
	14	(41395.20 ± 21766.75) ^{a,a}
P1	0	(43699.20 ± 9426.64) ^{a,a}
	7	(45862.40 ± 16360.71) ^{a,b}
	14	(44005.60 ± 16360.71) ^{a,a}
P2	0	(42150.40 ± 8545.57) ^{a,a}
	7	(57212.00 ± 20371.10) ^{a,b}
	14	(27168.00 ± 3857.03) ^{a,a}
P3	0	(43699.20 ± 9426.64) ^{a,a}
	7	(67827.20 ± 25163.09) ^{a,b}
	14	(36729.60 ± 4120.95) ^{a,a}

Description : The same superscript letters in the same column states non-significant difference at the level of $p \geq 0.05$

Table 1 shows that the average lymphocyte count in each treatment group did not differ significantly. The average lymphocyte count in age 0 day (DOC) ranges (42150.40 ± 8545.57)^{a,a} - (43699.20 ± 9426.64)^{a,a}/mm³. The average value of lymphocyte count in age 7 days (45862.40 ± 16360.71)^{a,b} - (81548.80 ± 25762.71)^{a,b}/mm³ and the average value of highest lymphocyte count at this age is in treatment group P0 ((81548.80 ± 25762.71)^{a,b}/mm³). On age 14 days or 7 days after infection, the average lymphocyte count ranges (27168.00 ± 3857.03)^{a,a} - (44005.60 ± 16360.71)^{a,a}/mm³ and the average value of the lowest lymphocyte count at this age is in treatment group P2 ((27168.00 ± 3857.03)^{a,a}/mm³).

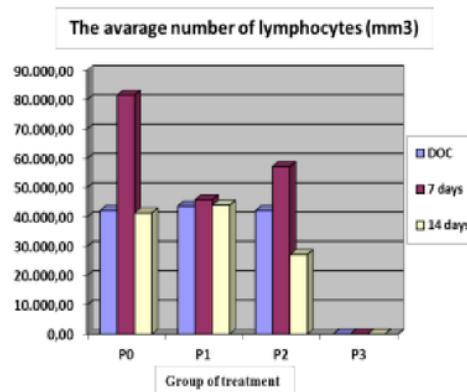

Fig. 1. The average of lymphocyte count (/mm³)

Fig. 1 shows that 7-day old chicken have a decrease in average lymphocytes count in the treatment group continued to increase at P1, P2 and P3 treatment groups. Chicken aged 14 days or 7 days after infection shows a decrease in the average lymphocytes count in treatment group P2.

3.2. Total Basophiles

Table 2. Average and Standard Deviation ($X \pm St. D$) Total Basophiles ($/mm^3$)

Treatment	Aged	$X \pm St. D$
P0	0	$(0.00 \pm 0.00)^{ab,a}$
	7	$(0.00 \pm 0.00)^{ab,a}$
	14	$(204.80 \pm 280.43)^{ab,b}$
P1	0	$(0.00 \pm 0.00)^{b,a}$
	7	$(0.00 \pm 0.00)^{b,a}$
	14	$(1616.80 \pm 2154.45)^{b,a}$
P2	0	$(0.00 \pm 0.00)^{ab,a}$
	7	$(0.00 \pm 0.00)^{ab,a}$
	14	$(204.80 \pm 311.57)^{ab,b}$
P3	0	$(0.00 \pm 0.00)^{a,a}$
	7	$(0.00 \pm 0.00)^{a,a}$
	14	$(0.00 \pm 0.00)^{a,b}$

Description: The same superscript letters in the same column states non-significant difference at the level of $p \geq 0.05$

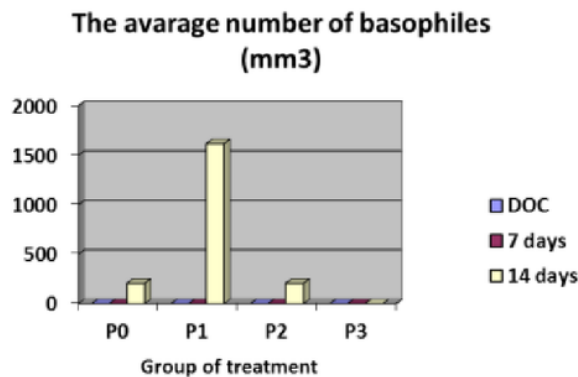

Fig. 2. The average basophile count ($/mm^3$)

Table 2 and Fig. 2 show that the basophils counts did not differ significantly, only in treatment group P1 aged 14 days or 7 days after infection shows significant increase in average basophil count. The average value of the number of basophils P1 at the age of 14 days or 7 days after infection ranges $(0.00 \pm 0.00)^{a,b}$ - $(1616.80 \pm 2154.45)^{b,a}/mm^3$ and the average value of the highest number of basophils at this age is in the treatment group P1 ($(1616.80 \pm 2154.45)^{b,a}/mm^3$).

At the age of 7 days ($P0 : (81548.80 \pm 25762.71)^{a,b}/mm^3$) the increase of average lymphocyte count was very significant compared to those in other treatment groups. Such improvement can be caused by a bacterial infection, where in treatment group there were a few chickens that died due to a bacterial infection, which was thought to have come from drinking water sources. According to Jackson⁶, the increase in leukocytes and lymphocyte count in poultry or birds can be caused by inflammation (infectious or noninfectious), poisoning, bleeding in body cavity, fast-growing neoplasms, and leukemia.

At the age of 14 days or 7 days ($P2 : (27168.00 \pm 3857.03)^{a,a}/mm^3$) after infection there was decrease in the average lymphocyte count as compared to those in other treatment groups. The decline may be caused by one of the curcumin compound in turmeric, the bisdesmetoxykurkumin. The nature of this compound is antagonistic to the work activity of curcumin and desmetoxykurkumin¹. According to Kohli⁷, one of the functions of turmeric (curcumin) is as an anti-inflammatory that can inhibit lymphocyte secretion into circulation. The inflammation comes from infected ND antigen and Newcastle disease incubation period is averagely 5-6 days^{2,3}. The provision of turmeric powder in certain dose can reduce lymphocyte count in blood since curcumin in turmeric can stimulate the secretion of glucocorticoid hormones that cause a decrease in lymphocytes count in the circulation⁴.

The administration of turmeric juice in multilevel doses (40%, 50%, and 60% turmeric juice) until the age of 14 days had no significant result, but the average lymphocytes count increased compared to normal lymphocyte

count. Normal chicken lymphocyte count is $5.45 - 18.4 \times 10^3/\text{mm}^3$. This is consistent with the function of one of the compounds present in turmeric, in which curcumin, as an immunomodulator, can increase total leukocytes count, including lymphocytes⁸.

The results of average basophils count showed that the administration of turmeric juice in graded doses (40%, 50%, and 60% turmeric juice) until the age of 14 days was not significant. The average basophils count in each treatment group ranged from $(0.00 \pm 0.00)^{ab}$ - $(1616.80 \pm 2154.45)^{b,a}/\text{mm}^3$. According to Swenson¹¹, normal basophil count in chickens is 0.36 to $1.32 \times 10^3/\text{mm}^3$. Basophils are rarely found in chicken blood. Less presence of basophils is normal, considering basophils have a very low power of phagocytic and normally there is only very small number of these cells in blood circulation.

Increased average basophil count in the age of 14 or 7 days after infection in group P1 treatment ($(1616.80 \pm 2154.45)^{b,a}/\text{mm}^3$) is due to inflammation caused by infection with ND antigen. Basophils will usually appear with the release of mediators for bleeding and allergic activity. Basophils play a role in a wide range of allergic reaction and would release heparin into the blood to prevent blood coagulation¹⁰. Basophils also has a function to evoke acute bleeding at the site of antigen deposit.

4. Conclusion

Provision of a dose of turmeric juice results in 40% increase in average lymphocytes and basophiles counts in chickens aged 14 days or 7 days after ND antigen infection.

231

Acknowledgements

The authors thank to the Head of the Department of Microbiology, Virology and Immunology, Faculty of Veterinary Medicine, Wijaya Kusuma Surabaya University for the facilities to do this research. This research was supported by Wijaya Kusuma Surabaya University Research Grant.

References

1. Afifah E. Khasiat dan manfaat temulawak. Jakarta: Agromedia Pustaka; 2003
2. Alexander DJ, Aldous EW. The long view : a selective review of 40 years of Newcastle Disease Research. *Avian Pathology* 2012; 41: 329-35.
3. Alexander D. Newcastle disease, other avian paramyxovirus, and pneumovirus infection. In: Syarif YM, Barnes HJ, Fadly AM, Glysson JR, McDougald LB, Swyne DE. *Disease of poultry*. IOA, USA: Blackwell publishing professional. IOA; 2003. p.63-98.
4. Ganiswara. *Farmakologi dan Terapi*. 4rd ed. Jakarta: Gaya Baru; 1995
5. Hollman PM. Analysis and health effect of flavonoids. *Food Chemistry* 1996;57: 43-6.
6. Jackson M. *Veterinary Clinical Pathology : an introduction*. USA: Blackwell Publishing; 2007
7. Kohli KJ. Curcumin : a natural antiinflammatory agent. *Indian. J. Pharmacol* 2005;37: 141-7.
8. Napirah AS. Pengaruh penambahan tepung kunyit (Curcuma domestica Valet). In: *Pakan terhadap parameter hematologi darah puyuh (coturnix-coturnix japonica) pedaging*. Yogyakarta: Universitas Gajah Mada; 2013.
9. Varalaksmi, et al. Immunomodulatory effects of curcumin : in vivo. *Int.Immunopharmacol* 2008;8:688-700.
10. Wakenel PS. Hematology of chickens and turkeys. In: *Schalm's Veterinary Hematology*. 6hd ed. Blackwell Publishing; 2010.
11. Swenson MJ. *Duke's physiology of domestic animal*. 9th ed. London: Cornell University Press; 1993.



Institute of Tropical
Disease
Universitas Airlangga

in a collaboration
with



Institute for Protein Research
Osaka University

Proceeding

Molecular and Cellular Life Sciences:
Infectious Diseases, Biochemistry and
Structural Biology
MCLS 2015

ISBN 978-602-14292-4-2

In The Case of An Emphysematous Lung, Could MMP-9 Activity of Gingival Crevicular Fluid Substitute that of The Sputum?

Mulkan Azhary^{a*}, Muhammad Amin^b, Soetjipto^b, Mulyadi^a and Sunnati^c

^aFaculty of Medicine, Syiah Kuala University, Kopelma Darussalam, Banda Aceh 23111, Indonesia

^bFaculty of Medicine, Universitas Airlangga, Prof. Dr. Moestopo 47, Surabaya 60131, Indonesia

^cFaculty of Dentistry, Syiah Kuala University, Kopelma Darussalam, Banda Aceh 23111, Indonesia

Abstract

The imbalance between the matrix metalloproteinase (MMP)-9 and the tissue inhibitor of metalloproteinase (TIMP)-1 may serve the proteolysis degradation of extracellular matrix (ECM). MMP-9 has been mainly produced by alveolar macrophages and granulated neutrophils leading to destruction of extracellular matrix (ECM). This study aimed to propose a less invasive relevant biomarker from gingival crevicular fluid (GCF). Fifteen smokers with emphysema underwent the physical assessment, the spirometry, and radiological examination. Both GCF and sputum were collected to measure MMP-9 activity. Results showed that the activity of MMP-9 between GCF and sputum differed insignificantly ($p > 0.05$). The MMP-9 activity of GCF might substitute the one of the sputum among emphysematous respondents and be suggested as a biomarker for emphysema.

Keywords: ECM; GCF; Sputum; MMP-9; Biomarker

Nomenclature

BAL	Broncho-alveolar lavage
COPD	Chronic obstructive pulmonary disease
CT	Computerized tomography
EBC	Expiratory breath condensate
ECM	Extracellular matrix
FEV ₁	Forced expiratory volume in 1 second
FVC	Forced vital capacity
GCF	Gingival crevicular fluid
GOLD	Global initiative for chronic obstructive lung disease
MMP	Matrix metalloproteinase
TIMP	Tissue inhibitor of metalloproteinase

1. Introduction

Smoking has been the major risk factor for the development of the chronic obstructive disease (COPD) among smokers. On the averagem COPD has developed into 20-25% among smokers. The more cigarette consumed is linear with the higher risk occurring among smokers¹. Smoking also exposes oral cavity including the periodontal tissues^{2,3}.

Smoking induces inflammatory responses releasing neutrophils, macrophages, lymphocytes as well as pro inflammatory cytokines from epithelial tissues, fibroblast, and cultured macrophage. Prolonged exposure could

601

* Corresponding author. Tel.: +6282160168314 ; fax: -.
E-mail address: mulkan.azhary@unsyiah.ac.id

make morphological and physiological changes in the lung parenchyma i.e. the disorder of alveolar septa, the enlargement of terminal bronchioles, the decrease of alveolar elastic recoil and more of other disorders of lung and respiratory tracts⁴.

Biomarkers have been developed in order to assess the severity of the disease based on related molecules and agents from either cells or tissues. Cytokines, chemokines, oxidants and proteases are taken as biomarkers to evaluate pathophysiology, inflammation, destruction and lung remodeling in COPD. These biomarkers are commonly taken from bronchial biopsy, bronchoalveolar fluid (BAL), sputum, and expiratory breath condensate (EBC)^{5,6}.

Emphysema mostly occurs as the process of elastolytic destruction since MMP-9 activity increases and so does MMP-9/TIMP-1 ratio^{7,8}. The evaluation for both MMP-9 activity and MMP-9/TIMP-1 ratio has been beneficial to assess the progressivity of emphysema among COPD patients⁹. Those parameters also occur in destructing periodontal tissues¹⁰. Some studies still engaged MMP-9 activity to assess the recovery of COPD and periodontitis among patients who quit smoking after treatment as MMP-9 activity has shown the elevated and less influenced recovery of diseases^{11,12}.

Due to patients' similar exposure and final state, this study aimed to associate the correlation between MMP-9 activity in periodontal and the one in lung tissues in order to evaluate the progressivity of emphysema.

2. Methods

The study methods and procedures have been officially approved by The Ethical Committee of Faculty of Medicine, Syiah Kuala University, Banda Aceh, Indonesia. Fifteen respondents were employed in this research. They were outpatients at Pulmonary Department of Zainoel Abidin Hospital, Banda Aceh-Indonesia. They were male, >50 year olds, smokers or former smokers, with 20 pack years and more, and without periodontal pocket. Those with asthmatic, infection of respiratory lower tract and pulmonary malignancies were excluded.

Furthermore, all eligible respondents had to undergo the physical examination, the spirometry test, and CT scan as well. This study showed FEV₁/FVC ratio <70%, FEV₁% predicted <50%. Next, respondents underwent sputum induction with nebulizer-assisted 3% NaCl solution collected into sterile pots. Then, GCF was collected by putting small piece of cut *Whatman*[®] filter papers (2 mm x 8 mm) into gingival sulcus stored into micro-centrifuge tubes¹³. All samples were preserved into 80°C freezer for further analysis. The activity of MMP-9 from both sputum and GCF was analysed with *Sensolyte*[®] 520 Generic MMP assay kit Fluorimetric.

587

3. Results and Discussion

3.1. Characteristics of respondents

Respondents' mean age (SD) was 59.53 (5.579) with 33.40 (6.468) pack years. Spirometry tests showed mean FEV₁/FVC ratio (SD) and FEV₁ predicted i.e. 44.648 (7.356) % and 34.33 (6.377) % respectively. This was in accord with the criteria of COPD based on GOLD¹⁴. The above data were shown in table 1.

Table 1. Characteristics of respondents based on age and pack year

Variables	N	Mean (SD)
Age (yr)	15	59.53 (5.579)
Pack year	15	33.40 (6.468)
FEV ₁ /FVC ratio (%)	15	44.648 (7.356)
FEV ₁ % predicted (%)	15	34.33 (6.377)

3.2. Activity of MMP-9 from GCF and sputum

Mean MMP-9 activity (SD) from GCF and sputum was 0.939 (0.722) μ M and 1.653 (1.574) μ M respectively. Activity of MMP-9 from sputum was higher than the one from GCF, as shown in table 2.

Table 2. Activity of MMP-9 from GCF and sputum

Variables	N	Mean (SD)
MMP-9 activity (μ M) (GCF)	15	0.939 (0.722)
MMP-9 activity (μ M) (Sputum)	15	34.33 (1.574)

3.3. Correlation of MMP-9 activity between GCF and sputum

After the data were calculated with paired sample t test, the correlation of MMP-9 activity between GCF and sputum showed insignificant differences ($p > 0.05$) as seen in Table 3.

Table 3. Paired sample t test of MMP-9 activity between GCF and sputum

Variable	n	Mean (SD)	p value
MMP-9 activity (μM)	15	0.714 (1.948)	0.177

3.4. Discussion

Mostly, COPD occurs in midyears as conducted in the study including respondents whose mean age (SD) was 59.53 (5.579) years old. Respondents also had more than 20 pack years, i.e. mean (SD) 33.40 (6.468) pack years. They had been diagnosed with COPD as they had worse FEV₁/FVC ratio and FEV₁ % predicted according to GOLD¹⁴ (Table 1). Smoking cessation among smokers was supposedly difficult to begin until they suffer from clinical signs and symptoms of airway obstruction. This condition was common among public to comply with the widespread smoking warning advertised and promoted. Supports from medical staffs helped smokers with COPD to quit smoking. However, healthy smokers still kept smoking although they had similar supports from medical staffs¹⁵.

Emphysema is caused by destruction of lung parenchyma mainly known by the decrease of FEV₁. The compensatory of upper lobes of lungs might increase the perfusion and ventilation instead of the disorder of lower lobes. The decline of FEV₁ in emphysematous lung occurs since the closure of lower lobe airways is faster during the expiration due to collapsed airways and the extracellular matrix (ECM) degradation. Structures of lower lobes contribute more than those of upper lobes so that the decrease of FEV₁ reflects disorders of lower lobes as emphysema mostly occurs within these parts¹⁶.

Regarding mean MMP-9 activity (SD) (Table 2), respondents had lower MMP-9 activity from GCF than the one from sputum. Lung parenchyma is more susceptible to suffer from degradation than periodontium since smoking might directly expose the lung and the respiratory tract. However, periodontitis would be mainly caused by prolonged exposure of smoking³. Age, pack year, and gender have influenced the spirometry and MMP-9 activity among smokers with COPD. MMP-9 activity is regulated tightly by genetic factor and its anti protease. The number of MMP-9 activities is not the key point to cause an emphysema among smokers as individual genetic susceptibility and amount of anti protease maintaining the balance might lead the fate of increasing MMP-9 activity among smokers¹⁷. The appropriateness of included respondents and matched inclusion criteria should be considered fairly since cigarette consumptions and ages may influence results. The insignificant difference of MMP-9 activity among healthy smokers was also found compared to smokers with COPD. It seems that healthy smokers still accumulate more exposures to keep increased induction of neutrophils within airway leading to the release of MMP-9¹⁸.

Neutrophils, monocytes, and macrophages release MMP-9 from epithelial tissues were found in GCF in which increased amount of MMP-9 had effects in degradation of ECM within periodontium¹⁰. Smoking habit led to the increasing amount of neutrophils from airway, subsequently followed by increased activity of MMP-9. Neutrophil is well known as a source of MMP, particularly MMP-9¹⁸. Smoking injured tissues of periodontium and respiratory, and induced neutrophils, macrophages and lymphocytes to release and activate MMP-9. The severity of inflamed tissues was linear with release of MMP-9 into the circulation¹⁷. Although the study did not focus on periodontitis, ECM degradation has been mostly caused by the increased activity of MMP-9¹⁰.

The imbalance of protease and anti protease, found in sputum, normally increased among COPD respondents. However, the correlation of MMP-9 activity was linear with the number of neutrophils from inflamed airways caused by prolonged exposure of smoking leading to the ECM degradation of lung parenchyma, commonly known as emphysema. Moreover, airway obstruction commonly occurs in small airways and lung parenchyma evaluated with radiological examination and spirometry^{9,19,20}.

The insignificant difference of MMP-9 activity ($p > 0.05$) (Table 3) between GCF and sputum concluded that MMP-9 activity from GCF would substitute the one from sputum. Although periodontitis and COPD were independently associated with each other, smoking exposure would affect pathogenesis course of either periodontitis or COPD which then will activate various mediators of pro inflammatory mediators, macrophages and neutrophils releasing MMP-9. Active MMP-9 is able to cleave ECM of related tissues, i.e. periodontium and lung parenchyma. Additionally, periodontitis may serve as a risk factor for COPD as bacteria from periodontitis sites might spread rapidly to respiratory tract. Bacteria from those infected sites could lead the exacerbation among COPD patients. However, causality effect of both diseases remained obscure^{3,21}.

4. Conclusion

This study suggests that the MMP-9 activity from GCF be a useful biomarker to assess progressivity of emphysema. Then, further studies should be conducted in order to determine better proximity between periodontium and lung parenchyma.

References

1. Anwar D, Chan Y, Basyar M. Hubungan Derajat Sesak Napas Penderita Penyakit Paru Obstruktif Kronik Menurut Kuisioner Modified Medical Research Council Scale dengan Derajat Penyakit Paru Obstruktif Kronik. *J Respir Indo* 2012;32(4):200-207.
2. Pejčić A, Obradović R, Kesić L, Kojović D. Smoking and Periodontal Disease A Review. *Facta Universitatis Series: Medicine and Biology* 2007;14(2):53-59.
3. Usher AK, Stockley RA. The Link between Chronic Periodontitis and COPD: a Common Role for the Neutrophils? *BMC Medicine* 2013;11(41):1-11.
4. Daheshia, M. Pathogenesis of Chronic Obstructive Pulmonary Disease (COPD). *Clinical and Applied Immunology Reviews* 2005;5:339-351.
5. Snell N, Newbold P. The Clinical Utility of Biomarkers in Asthma and COPD. *Current Opinion in Pharmacology* 2008;8(3):222-235.
6. Cazzola M, Novelli G. Biomarkers in COPD. *Pulmonary Pharmacology & Therapeutics* 2010;23(6):493-500.
7. Churg A, Zhou S, Wright JL. Matrix metalloproteinases in COPD. *European Respiratory Journal*, 2012;39(1):197-209.
8. le Quément C, Lagente V, Guénon I, Muzio V, Gillon J-Y, Boichot E. Anti-Inflammatory Properties of MMP Inhibitors in Experimental Models of Chronic Obstructive Pulmonary Disease and Lung Inflammation. In: Lagente V, Boichot E, editors. *Matrix Metalloproteinases in Tissue Remodelling and Inflammation*. Basel: Birkhäuser; 2008. p. 57-69.
9. Boschetto P, Quintavalle S, Zeni E, Leprotti S, Potena A, Ballerini L, Papi A, Palladini G, Luisetti M, Annovazzi L, Iadarola P, Rosa ED, Fabbri LM, Mapp CE. Association between Markers of Emphysema and More Severe Chronic Obstructive Pulmonary Disease. *Thorax* 2006;61(12):1037-1042.
10. Rai B, Kaur J, Jain R, Anand SC. Levels of gingival crevicular metalloproteinases-8 and -9 in periodontitis. *Saudi Dent J*. 2010;22:129-132.
11. Louhelainen N, Stark H, Mazur W, Ryttilä P, Djukanovic R, Kinnula VL, Louhelainen N., Stark, H., Mazur, W. Elevation of Sputum Matrix Metalloproteinase-9 Persists up to 6 Months after Smoking Cessation: A Research Study. *BMC Pulmonary Medicine* 2010;10:13.
12. Rauten AM, Surlin P, Oprea B, Silosi I, Moisa M, Caramizaru D, Vătu M. Matrix Metalloproteinase 9 Level in Gingival Crevicular Fluid in Patients after Periodontal Microsurgery for Orthodontic Induced Gingival Hypertrophy. *Rom J Morphol Embryol* 2011;52(1 Suppl):431-433.
13. Johnson RB, Streckfus CF, Dai X, Tucci MA. Protein recovery from several paper types used to collect gingival crevicular fluid. *J Periodont Res* 1999;34(6):283-289.
14. *Global Strategy for the Diagnosis, Management and Prevention of COPD*. Global Initiative for Chronic Obstructive Lung Disease (GOLD) 2015. Available from: <http://www.goldcopd.org/>.
15. Stratelis G, Jakobsson P, Molstad S, Zetterstrom O. Early Detection of COPD in Primary Care: Screening by Invitation of Smokers Aged 40 to 55 Years. *British Journal of General Practice* 2004;54(500):201-206.
16. Holme J, Stockley RA. Radiologic and Clinical Features of COPD Patients with Discordant Pulmonary Physiology: Lessons from Alpha1-Antitrypsin Deficiency. *CHEST* 2007;132(3):909-915.
17. Fujita M. The Role of MMPs in the Progression of Chronic Lung Inflammatory Diseases. In: Ong K-C, (Editor). *Lung Inflammation*. ISBN: 978-953-51-1373-7, InTech; 2014 DOI: 10.5772/57391. Available from: <http://www.intechopen.com/books/lung-inflammation/the-role-of-mmps-in-the-progression-of-chronic-lung-inflammatory-diseases>.
18. Lowrey GE, Henderson N, Blakey JD, Come JM, Johnson SR. MMP-9 protein level does not reflect overall MMP activity in the airway of patients with COPD. *Resp Med* 2008;102:845-851.
19. Kang MJ, Oh Y-M, Lee JC, Kim DG, Park MJ, Lee MG, Hyun IG, Han SK, Shim Y-S, Jung K-S. Lung Matrix Metalloproteinase-9 Correlates with Cigarette Smoking and Obstruction of Airflow. *J Korean Med Sci* 2003;18:821-7.
20. Chaudhuri R, Mcsharry C, Spears M, Brady J, Grierson C, Messow C, Miele G, Nocka K, Maenee W, Connell M, Murchison JT, Sproule M, Hilmi O, Miller DK, Thomson NC. Sputum Matrix Metalloproteinase-9 is Associated with the Degree of Emphysema on Computed Tomography in COPD. *Translational Respiratory Medicine* 2013;1(11):1-5.
21. Peter KP, Mute BR, Doiphode SS, Bardapurkar SJ, Borkar MS, Raje DV. Association between Periodontal Disease and Chronic Obstructive Pulmonary Disease: A Reality or Just a Dogma? *J Periodontol* 2012;84:1717-1723.



Institute of Tropical
Disease
Universitas Airlangga

in a collaboration
with



Institute for Protein Research
Osaka University

Proceeding

Molecular and Cellular Life Sciences:
Infectious Diseases, Biochemistry and
Structural Biology
MCLS 2015

ISBN 978-602-14292-4-2

8

Cloning and Expression of cDNA Encoding Membrane Protein of Tachyzoite of *Toxoplasma gondii* Local Isolate in Bacteriophage

Mufasirin^{a*}, Wayan T. Artama^b, Sumartono^b, and Sri Suhartati^b

^aInstitute of Tropical Disease, Faculty of Veterinary Medicine, Universitas Airlangga, Surabaya 60115, Indonesia

^bFaculty of Veterinary Medicine, Gadjah Mada University, Yogyakarta 55281, Indonesia

Abstract

Toxoplasmosis is a disease caused by obligatory intracellular protozoa of *Toxoplasma gondii*. Generally, diagnosis relies on serological methods. However, immuno diagnosis might be indistinct in immunocompromised patients. The aims of the research are to clone and to express cDNA encoding membrane protein of *Toxoplasma gondii* for developing molecular diagnosis. Total RNA and messenger RNA were isolated from tachyzoites growing up in Swiss strain mice by using PolyAtract[®]mRNA Isolation Systems (Promega) and cDNA was synthesized using Riboclone[®]cDNA Synthesis Systems (Promega). Complementary DNA was ligated with *EcoRI* adaptor using Riboclone[®]EcoRIAdaptor Systems (Promega). Bacteriophage of λ gt11 ligated with cDNA was transfected in *E. coli* Y1090. Recombinant plaque was analyzed using polyclonal antibodies against membrane protein of tachyzoite of *T. gondii*. Over-expression of recombinant was analyzed by dot blot technique in order to identify cDNA recombinant expressing membrane protein tachyzoite of *T. gondii*. Transfection in *E. coli* Y1090 by λ gt11 produced 7 clones with cDNA encoding membrane protein of tachyzoite of *T. gondii*.

Keywords: *Toxoplasma gondii*; tachyzoite; membrane protein; bacteriophage; cloning.

492

1. Introduction

Toxoplasmosis is a parasitic disease caused by *Toxoplasma gondii*. The disease is spread all over the world, and is more common in cold climate regions¹. In acute infections, the disease is asymptomatic and only shows a slight pain symptom which is usually undiagnosed². An infection in adults shows no clinical symptoms, but it sometimes shows lymphadenitis in cervical region and other regions accompanied by a mild fever³. In pregnant women and animals, severe infections can lead to miscarriage or congenital defects in infants born^{1,4}. Primary *Toxoplasma gondii* infection in pregnant women in the first trimester results in 20% of infected fetuses and the third trimester of pregnancy, the fetus is infected 65%⁵. In the definitive host, toxoplasmosis with extraintestinal cycle, clinical symptoms are common, but the cycle intraepithelial clinical symptoms are frequently seen, such as anterior uveitis, posterior uveitis, fever, muscle suffered hyperaesthesia, weight loss, not eating, breathing disorders, like attacking, and loss of balance^{6,7}.

Toxoplasmosis causes several clinical manifestations in individuals who suffer from immunosuppression and it can cause defects in infants born from infected mothers during pregnancy. In individuals with AIDS, *Toxoplasma* is an opportunistic parasite that causes a very serious problem⁸. Toxoplasmosis losses cause, either directly or indirectly, huge economic losses. In the United States, some researchers reported that toxoplasmosis in humans had caused economic losses covering medical costs and care for people with mental retardation⁹. The cost of the treatment of infants affected by congenital toxoplasmosis at the average was 67,246 dollars per patient⁸. Other economic losses due to toxoplasmosis are loss of income due to illness, death and reduction in work participation¹.

Toxoplasmosis is a disease that can be transmitted from animals to humans. It requires good disease control strategies which include knowledge of toxoplasmosis, treatment and vaccination of meat before eating. Prevention of toxoplasmosis can be done, for example, by cooking meat at the temperature of minimal 66°C for 20 minutes or by cooling it at the temperature of -20°C for several days. The use of gloves in the meat

* Corresponding author. Tel.: +6231-5992785 (ext 203); fax: +6231-5993015.
E-mail address: mufasirinfkunair@gmail.com

processing and washing hands after the meat processing are recommended⁶. Prevention is better than treatment to avoid the risk of toxoplasmosis¹⁰. *Toxoplasma gondii* vaccines that have been used are in the forms of a live vaccine (tachyzoite), the surface protein¹¹, and nucleic acids¹². Constraint on development of live vaccines is the development of the culture and the handling of tachyzoite which are relatively insecure and expensive; while, the surface protein is vaccine used as an antigen supply which is not easy. The use of inactivated vaccine and sub unit vaccine of *Toxoplasma* is one alternative to vaccination. However, the obstacles faced are contaminants, cost prohibitive in the provision, as well as toxic effects when administered in large quantities¹³.

Diagnosis of toxoplasmosis is often based on the presence of antibodies against *Toxoplasma*. Humans and animals showing seropositive for *Toxoplasma* is not necessarily suffering from toxoplasmosis, although once infected with *Toxoplasma*. Diagnosis is confirmed by finding cysts on the brain or tissue and the presence of *Toxoplasma* circulating in the form of bradyzoite or tachyzoite⁶. The Presence of antigens in the body can be detected by techniques Enzyme Linked Immunoassay (ELISA)⁶, Polymerase Chain Reaction (PCR)^{14,15,16}, Polymerase Chain Reaction - DNA Enzyme Immunoassay (PCR-DEIA)¹⁷. PCR diagnostics constraint-DEIA or hybridization tracker techniques provide *Toxoplasma* protein for the production of antibodies and DNA is used as a tracer.

Toxoplasma gondii is an obligate intracellular protozoan that infects several types of nucleated cells. Contacts among others, the receptors on host parasite with an initial entry of the parasite into the host¹⁸. P30 is a major membrane protein which is a ligand that is essential in *Toxoplasma*¹⁹. P30 is located on the membrane surface and rhoptri of tachyzoite²⁰. Tachyzoite of *Toxoplasma gondii* has five major proteins. The fifth of these proteins is SAG1 (P30) which is the most dominant major protein while SAG3 is the least amount of protein and other proteins are minor third²¹.

The development of recombinant DNA technology solves the problem of providing a surface protein that is immunogenic in a large amount. Therefore, the production of the vaccine may be cheaper. Recombinant DNA technology can also provide a solution in providing both nucleic acid used as a vaccine and material for hybridization tracers in the diagnosis of disease. Lambda gt11 Vectors which are often used for engineering is a bacteriophage. Bacteriophages are viruses that infect bacteria. One of the bacteriophages that are often used in cloning technology is bacteriophage lambda. Bacteriophage lambda genome is double-stranded DNA with a length of about 50 kb. DNA bacteriophage particles form linear double-stranded molecule with edges which is a single chain complementary to the other end and at the end, 12 nucleotides are in length complementary. After infecting bacteria, complementary ends of both ends of cohesive joining partner base circular form molecules and these molecules are used as a template for the transcription process. The materials integrate with the cell genome and replicate together with the host cell. Bacteriophage lambda does not only replicate and infect bacteria causing lysis, but it can also integrate into the genome and the phenomenon is called lysogenization. Lysogenic *E. coli* bacteria replicate the foreign DNA as the genetic material itself during lytic function. Bacteriophage vector is often chosen because it has a cloning capacity large enough to insert foreign DNA. Genotype selection is easy and it has a lot of side polylinker with restriction²². Lambda gt11 is often used in cloning because it has the properties phage easily packaged in vitro and selection because it has a *lacZ* gene. Insertion of *lacZ* gene inactivates the gene encoding the β -galactosidase so it is not capable of changing the substrate X-Gal that plague pale colored transparent. Since there is no insertion of blue plaque. At λ gt11, induction *lacZ* fusion protein will be expressed containing β -chain protein that is bound galactosidase on DEAE-cellulose²².

2. Methods

2.1 Cultivation parasite in vivo

Three mice were injected with tachyzoite of *Toxoplasma gondii* local isolate by intraperitoneally with a dose of 1×10^7 . After 72-96 hours, the mice showed marked clinical symptoms with fur standing, weakness, no appetite and drinking, decreased respiratory rate and quick heart rate. Mice were then sacrificed and the abdominal cavity was washed with physiological saline fluid to get tachyzoite. The washing was done three times, each was about 5 ml. Tachyzoite was then infected into 30 adult male mice with a dose of 1×10^7 to get more tachyzoite in the same way as the previous way. Then, the results of washing abdominal cavity of mice were centrifuged at 3000 rpm (Beckman) at 4°C for 10 minutes. Obtained pellets were washed three times with PBS containing 0.1% diethyl pyrocarbonat (DEPC) by centrifugation at 3000 rpm at 4°C for 10 minutes and then pellets were ready to be used for total RNA preparation.

2.2 Isolation of RNA

2.2.1 Total RNA isolation

Some 10^{10} tachyzoites were coupled with 1.5 ml of guanidine thiocyanate and mixed by means of resuspended, then the mixture was transferred into a sterile homogenizer RNase-free tubes. Homogenization was done with the homogenizer 6 times, each with a speed of 1200 rpm for 30 seconds. Homogenization was done in a cold state in order to avoid damage to RNA. The results of homogenization were transferred into RNase-free sterile tube, then it was added with Na-acetate-tenth of the volume and it was mixed until blended. The solution was put in ice for 5 minutes and added with phenol chloroform as much. Mixing was done by flipping and turning the tube and incubated on ice for 15 minutes. Aqueous phase was obtained by centrifugation with 4000 rpm on 4°C for 25 minutes. Aqueous phase was transferred into new sterile RNase-free tubes and added with isopropanol (1:1) and mixed with way of flipping through the tube. The solution was then incubated at -20°C overnight. The solution was centrifuged at 4000 rpm at 4°C temperature for 25 minutes. Obtained pellet was washed with cold 75% ethanol and centrifuged at 4000 rpm at 4°C for 25 minutes. The supernatant was then discarded and the pellets were dried until completely dry at room temperature. The next pellet was resuspended with 250 µl RNase-free water.

2.2.2 mRNA isolation

2.2.2.1 Annealing probe

Messenger RNA was isolated using PolyAtract®mRNA Isolation System. Two hundred and fifty microliters of total RNA were coupled with RNase-free water until the volume became 500 µl. The solution was incubated at 65°C for 10 minutes. Immediately after the incubation, the solution was added with 3 µl biotinylated oligo (dT) probe and 13 µl 20XSSC. The solution was mixed and incubated at room temperature for 10 minutes.

2.2.2.2 Washing streptavidin-paramagnetic particles (SA-PMPs)

Streptavidin-paramagnetic particles (SA-PMPs) were resuspended to solution, then they were captured by placing a magnetic stand for 30 seconds until the SA-PMPs collected on the wall (the solution becomes clear). Streptavidin-paramagnetic particles were washed three times with 0.5x SSC (each wash as much as 0.3 ml) in a manner as was done previously and then were resuspended in 0.1 ml of 0.5x SSC.

2.2.2.3 Arresting and washing hybrid mRNA with oligo (dT)

The reaction solution annealing was inserted into the tube containing the SA-PMPs, then it was mixed and incubated at room temperature for 10 minutes. Complex SA-PMPs with hybrid mRNA and oligo (dT) were captured by placing a magnetic stand until the solution became clear. Supernatant was discarded carefully to avoid damage to SA-PMPs pellets. Streptavidin-paramagnetic particles were washed four times with 0.1x SSC (each wash as much as 0.3 ml) as shown above by placing a magnetic stand until the solution became clear.

2.2.2.4 Elution of mRNA

SA-PMPs pellet were resuspended in 0.1 ml RNase free water, then they were captured by the magnetic stand. Aqueous phase was taken and put in new sterile RNase-free tubes. Washing was repeated by adding 0.15 ml of RNase-free water. Then, SA-PMPs were captured by using a magnetic stand. Aqueous phase was taken with caution and put in a new sterile tube which had been washed with distilled DEPC.

2.2.2.5 Precipitation and concentration of mRNA

Two hundred and fifty microliters of mRNA elution process results were coupled with 25 µl Na-acetate and 250 µl isopropanol, then they were blended until smooth and incubated on -20°C overnight. The reaction mixture was then centrifuged at 12000 rpm at 4°C for 25 minutes. Pellets were resuspended in 1 ml of ethanol; 75% cold and centrifuged at 12000 rpm at 4°C for 25 minutes. The supernatant was discarded and the pellets were dried at room temperature. Pellets were resuspended with 10 µl RNase free water and stored at a temperature -70°C. mRNA concentrations were seen by spectrophotometer at OD₂₆₀.

2.3 cDNA Synthesis

2.3.1 Single strand cDNA synthesis

Ten microliters of solution containing 2 µg mRNA, 1 µl oligo (dT) primer, and 4 RNase-free water were mixed. The reaction mixture was then incubated at 70°C for 5 minutes and centrifuged for 5 seconds at a speed of 12000 rpm for lowering all solution. The reaction mixture was then added with 5 µl single strand 5X buffer, 25 U rRNasin ribonuclease inhibitor, 2.5 µl 40 mM sodium pyrophosphate, 15 U AMV reverse transcriptase RNA, and RNA free water to a final volume of 25 µl. The reaction solution was mixed well and incubated at 37°C for 60 minutes. After the incubation, the solution was stored in ice to be used for double strand synthesis.

2.3.2 Synthesis of double-stranded cDNA

Twenty microliters of the reaction mixture on the synthesis of single-stranded plus an additional 10 10X µl second strand buffer, 23 U of DNA polymerase I, 0.8 U RNaseH, and nuclease free water were mixed to obtain a final volume of 100 µl. The reaction solution was mixed well and incubated at 14°C temperature for 3 hours. The polymerization reaction was stopped by heating at 70°C for 10 minutes. The tube containing the reaction mixture was centrifuged at 12000 rpm for 5 seconds to bring down all liquid and then it was placed on ice. The reaction mixture was further added with 2 U T4 DNA polymerase and incubated at 37°C for 10 minutes. Reaction stopped by adding 10 µl 200 mM EDTA and placed on ice. DNA extraction was done by added Phenol : isoamylalcohol chloroform, 1: 1. Solution was mixed well and centrifuged at 12000 rpm for 2 minutes at room temperature. Aqueous phase was transferred into a new tube, then it was added half times the volume of 7.5 M ammonium acetate and two and a half times the volume of cold absolute ethanol. The solution was mixed with gentle and incubated at -20°C overnight. After incubation, the reaction mixture was centrifuged at 12000 rpm at 4°C temperature for 25 minutes. Pellets were resuspended with cold 75% alcohol and centrifuged at the same speed. The supernatant was discarded and the pellets were dried at room temperature until totally dry. Pellet was resuspended with 10-50 µl TE buffer. DNA concentration was measured with a spectrophotometer at OD₂₆₀.

2.4 Addition of *EcoRI* adapter in cDNA

The addition of the adapter *EcoRI* uses Riboclone®*EcoRI* Adaptor Ligation System. A total of 2.5 µl DNA (100 ng/µl) added 3 µl T4 DNA ligase buffer, 3 µl BSA (1 mg/ml), 1 µl *EcoRI* adapter, 2.5 U T4 DNA ligase and nuclease free water to a final volume of 30 µl. The reaction mixture was mixed well and incubated at 15°C temperature overnight. To stop the reaction, the reaction mixture was incubated at 70°C for 10 minutes.

2.5 Reaction of phosphorylation

Thirty microliters of DNA ligated with *EcoRI* adapter were added to 4 µl T4 polynucleotide kinase buffer 10X, 2 µl 0.1 mM ATP, 1 µl polynucleotide T4 kinase 10 U and nuclease free water to obtain a final volume of 40 µl. The reaction mixture was mixed well and incubated at 37°C for 30 minutes. The reaction mixture was extracted with phenol chloroform adding as much and blended well for 30 seconds at a speed of 12000 rpm centrifuged for 3 minutes. Aqueous phase was transferred into a new tube and re extraction to obtain maximum results by adding 20 µl TE buffer. Phase aqueous was then added with half times volume 7.5 M ammonium acetate and two volumes of cold absolute ethanol. The solution was mixed well and incubated at -20°C overnight. To obtain a pellet, a solution was then centrifuged at 3000 rpm at 4°C for 25 minutes. The supernatant was discarded and the pellet was washed with cold 75% ethanol. Pellets were dried at room temperature until completely dry and were resuspended with 10 µl TE buffer.

2.6 Elimination of excess adapters

Sephacryl S-400 which had been thoroughly mixed in a tube was inserted into the column and allowed a few minutes for all solvent buffers down to the bottom. Column tube was inserted into the tube, centrifuged at 2500 rpm, and washed with rotor SW for 5 minutes. Centrifugation was repeated when a column of Sephacryl still imperfectly dry. Column tube was taken and DNA samples were inserted into the column using a micropipette. The addition of DNA samples was done right at the top of the column and maximum volume of 60 µl. Column tube was inserted into the collector tube and centrifuged at 2500 rpm for 5 minutes. Supernatant were accommodated in the collector tubes ready for ligation reactions with the vector.

2.7 Transfection and analysis of results

2.7.1 Preparation of bacterial cultures

A single colony of *E. coli* Y1090 was cultured in 3 ml LB medium containing 0.2% maltose and 10 mM MgSO₄ and incubated at 37°C temperature with agitation speed of 200 rpm overnight. Five hundred microliters of an overnight bacterial culture results were added to 50 ml of LB media already containing 0.2 maltose and 10 mM MgSO₄ and incubated at 37°C until OD₂₆₀ showing the growth ranging from 0.6 to 0.8. Bacterial cultures were then stored at 4°C overnight.

2.7.2 Ligation of cDNA into a vector λ gt11

A total of 2 μ l λ gt11 *Eco*RI arms (0.5 μ g/ μ l), were coupled with 3 μ l nuclease-free distilled water and 1 μ l T4 DNA ligase (10-15 U/ μ l). Positive control ligation reactions used 4 μ l λ gt11 *Eco*RI arms (1 μ g), 2 μ l positive control insert (0.4 μ g), 1 μ l 10X ligase buffer, and 1 μ l T4 DNA ligase. Negative control used the same arrangement with the arrangement of the cDNA sample, but was not coupled with cDNA samples. The composition of the reaction was incubated at 14°C for overnight and ready for packing.

2.7.3 Packing of ligated DNA

Extract packer thawed in ice. Immediately after melting, the result of ligation reaction was added to the extract packer. For a positive control reaction, only 0.5 μ g DNA containing λ c1857 sam7 was added to extract packer. The reaction mixture was incubated at room temperature (22°C) for 3 hours. The reaction mixture was then added with 445 μ l page buffer and 2 μ l chloroform and mixed by means of tossing and turning the tube. Phage already packed can be stored at -4°C for 7 days.

2.7.4 Titration phage and transfection

Phage was packed to the titration by doing some dilution ie: 1:10, 1:100, 1:1000 and 1:10000. A total of 100 μ l phage dilution resulting solution was added to 100 μ l Y1090 bacterial culture and mixed well. For the positive control, the bacteria used are LE393. Incubation was carried out at 3°C for 30 minutes. While waiting for the incubation, 3 ml prepared to order warm (45°C) which had been coupled with 21 μ l 5 mg/ml X-gal, 21 μ l 20 mg/ml IPTG and 3 μ l 10 mg/ml ampicillin. After being incubated, the mixture of bacteria with phage was coupled with 3 ml of top agar, shaken and immediately poured onto LB agar plate which had previously been warmed 37°C. LB agar plates were then incubated at a temperature of 37°C for 8-10 hours, and the amount of plaque formed can be used to count packing efficiency.

2.7.5 Transfer of protein expression on nitrocellulose membrane

Nitrocellulose membranes are used and adapted to the plate used and labeled samples. Slowly, membrane placed on LB agar plate until blended. At the edge of the membrane, stitch was made as a marker of plaque on the LB agar plate orientation. Incubation was carried out at 37°C for 3 hours, and then cooled at a temperature 4°C for 20 minutes, so that the hardening occurred. Nitrocellulose membranes were taken by carefully using tweezers and washed with TTBS to remove the remaining 0.5% top agar.

2.7.6 Plaque screening with antibodies

Nitrocellulose membrane was washed with TTBS 0.5%, next blocked with 1% BSA overnight at 4°C, continued washed with 0.05% Tween 100 in TBS for 10 minutes, and the washing was repeated 3 times. Then, membrane was introduced into a solution of polyclonal antibody in PBS (1:50) and incubated 1 hour at room temperature with sacker, and washed with 0.05% Tween 100 in TBS for 10 minutes. Washing was repeated four times in the same manner. Furthermore, the membrane was incubated in a solution of conjugate (1:3000) (Santa Cruz, USA) for 1 hour at room temperature with sacker, and followed by washing five times with 0.05% Tween in TBS and one time without Tween. Membranes were stained with a substrate Western Blue Ready. The reaction was stopped when protein bands were visible by adding distilled water. Membrane was dried on Whatman paper and ready to be documented.

2.8 Over recombinant expression in *E. coli* Y1090

Recombinant plaques of the plate in order to be taken by way of insertion and extraction with Pasteur pipette. Plaques fetched were put in 500 BC μ l buffer and kept at that temperature overnight bacteriophage 4°C

regardless of the order. Preparation of bacterial culture Y1090 was done by growing a single colony of bacteria Y1090 in 5 ml LB medium containing 0.5% maltose and 10 mM MgSO₄. Incubation was carried out at 37°C with agitation of 200 rpm for overnight. A total of 500 µl culture overnight growth was added to 10-20 µl solution containing recombinant plaques. Incubation was carried out at 37°C for 20 minutes, and then the culture was put in 100 ml of warm LB medium containing 10 mM MgSO₄. Incubation was carried out at 37°C with agitation at a speed of 200 rpm for approximately 5 hours. If there were no cell lysis after 7 hours, the culture was added with 500 µl chloroform and agitated for 15 minutes at the same temperature. Lysate was taken and centrifuged at 2000 rpm 4°C temperature for 10 minutes. The supernatant was taken and stored at temperatures 4°C. Proteins with high concentrations were taken by precipitation by the addition of saturated ammonium sulfate (1:1). The reaction mixture was then incubated at 4°C overnight. Pellets were obtained by centrifuged at 4000 rpm at 4°C for 20 minutes. The supernatant was discarded and the pellet was resuspended with sterile aquabidest.

2.9 Immunoblotting with dot blot technique

A total of 10 µl lysate supernatant of bacterial growth Y1090 infected with recombinant or 2 µl λgt11 protein precipitation results dropped on a nitrocellulose membrane and allowed to dry. Negative controls used recombinant protein lysate proteins and protein precipitation results from bacterial growth Y1090 were not infected with λgt11. Nitrocellulose membrane was allowed to dry and then blocked with 1% BSA overnight at 4°C. Then, it was continued washed with 0.05% Tween 100 in TBS for 10 minutes, and the washing was repeated 3 times. Membrane was then introduced into a solution of polyclonal antibody in PBS (1:50) and incubated 1 hour at room temperature with sacker and washed with 0.05% Tween 100 in TBS for 10 minutes. Washing was repeated four times in the same manner. Furthermore, the membrane was incubated in a solution of conjugate (1:3000) (Santa Cruz, USA) for 1 hour at room temperature with sacker and followed by washing five times with 0.05% Tween in TBS and 1 time without Tween. Membranes were stained with a substrate Western Blue Ready. The reaction was stopped when protein bands were visible by adding distilled water. Membrane was dried on Whatman paper and ready to be documented.

3. Results and discussion

Total RNA isolated from tachyzoite of *Toxoplasma gondii* after electrophoresis on 1% agarose gel can be seen in Fig. 1.

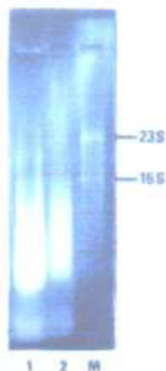

Fig. 1. Total RNA of *Toxoplasma gondii*
M: standard marker of *E. coli* rRNA; 1,2 RNA sample

In Fig. 1 visible sighting clears rRNA bands with bands visible mRNA smear bands between rRNA. In prokaryotes and eukaryotes including *Toxoplasma gondii*, the amount of mRNA contained in the cell is less than the other types of RNA. Messenger RNA isolated from total RNA obtains 1.5%. As a comparison, RNA in *E. coli*. *Escherichia coli* mRNA is only 5% of the total RNA, while the others are rRNA (80%) and tRNA (15%)²³. Messenger RNA is the result of transcription of the DNA which will then be translated to form proteins. Messenger RNA has different length according to the genes that encode, resulting in the electrophoresis to form thin ribbons that look smear. Of 5% mRNA, only few percent that will be translated into proteins. In addition, there are several types of RNA: mRNA, rRNA, and tRNA. In length, Ribosomal RNA nucleotides are longer than the tRNA, so electrophoresis rRNA bands will form a clear tape²⁴. In eukaryotes, it is obtained four kinds of rRNA : 5S; 5.8S; 18S; and 28S. rRNA which is in *E. coli* are 5S, 16S and 23S rRNA.

Messenger RNA is the result of transcription of DNA coding for a particular protein which is good for its

own purposes, secretion or as a surface protein that functions in the attachment to the host. Messenger RNA in eukaryotes has a poly A 3-prime chest. With the poly A at the 3-prime, mRNA can be easily separated by adding olido (dT) probe which has been added by biotin. With techniques developing Promega, complex poly AT has been added by biotin and mRNA molecules can be separated by adding puller made from paramagnetSpere streptavidin particles (SA-PMPs).

Transformation results in the form of blue plaques and white/transparent plaques. Plaque is a white plaque recombinant cDNA carrying inserts, and blue plaque is a plaque that does not carry cDNA inserts. The number of white plaques obtained from the transfection is about 40% of the total plaques formed. Plaque is formed on LB plate due to bacterial cell lysis results from infection λ gt11. Lamda gt11 is a phage that has a growth cycle of lytic in *E. coli* Y109025. The arrival of λ gt11 infecting host cells will lead to lysis of the bacteria. Lysis which occurs in bacteria is due to damage to the walls of bacteria because of enzymes released by phage²⁴. At the end of the cycle of infection, Phage synthesizes lysozyme or endolysin which causes damage to the bacterial cell wall. The outbreak of bacterial cells, the particles, will be released around the new phage in bacterial growth medium. The results of λ gt11 transfection into *E. coli* Y1090 can be seen in Fig. 2.

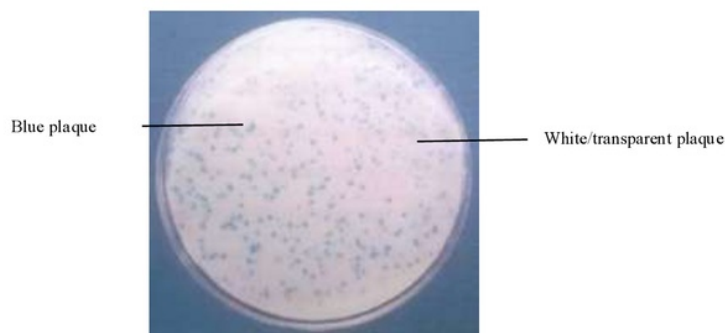

Fig. 2. The results of λ gt11 transfection into *E. coli* Y1090

White plaques occur due to the side restriction of *EcoRI* in genes encoding β -galactosidase inserted cDNA. Their insertion of foreign DNA in gene encoding β -galactosidase fusion protein results in the formation of the protein expression of foreign DNA, and makes β -galactosidase inactive. A β -galactosidase which is inactive causes the X-gal substrate bias is not described, and chromogenic dye is not formed. Conversely, when the side of the *EcoRI* restriction on genes encoding β -galactosidase is not inserted with foreign DNA, it will form an active β -galactosidase. An active β -galactosidase enzyme causes the substrate X-gal can be revamped and releases chromogenic dye blue. White plaques possibility of carrying cDNA encoding membrane protein of *Toxoplasma gondii* tachyzoite or cDNA encodes other proteins. To determine plaque carrying cDNA encoding the membrane protein of tachyzoite, screening is required. The use of antibodies against membrane proteins of *Toxoplasma gondii* can be used to select gene encoding as expected. The immunoblotting result of recombinant plaque with polyclonal antibody can be seen in Fig. 3.

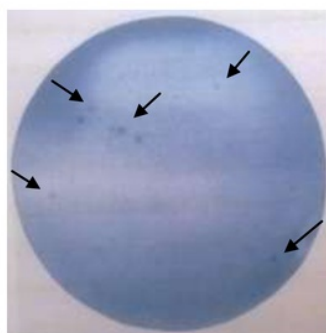

Fig. 3. Immunoblotting result of plaque recombinant with polyclonal antibody against *Toxoplasma gondii*. Arrows indicate the direction of plaque that expresses a membrane protein of tachyzoite *Toxoplasma gondii*

Selection of recombinant plaques carrying cDNA encoding membrane protein of *Toxoplasma gondii* is done by immunoscreening. Screening resulting in polyclonal antibody against the membrane protein obtains 7 clones carrying cDNA encoding membrane protein of *Toxoplasma gondii*, and which can be seen in Fig. 3.

Immunoblotting of recombinant plaque with polyclonal antibody against *Toxoplasma gondii* membrane protein is a blue black spot which is recombinant proteins that react with polyclonal antibodies against *Toxoplasma gondii* membrane protein. Polyclonal and monoclonal antibodies can be used to screen for the desired genes from libraries genes because the antibody has specific properties to foreign proteins known. Polyclonal antibodies used for the selection of clones are wider than the monoclonal antibody. Monoclonal antibody is specific for only recognizing one specific epitope on the protein to be expected²⁶. The mutant P30 (SAG 1) of *Toxoplasma* is detected clones in the library. Parasite clones that do not carry genes P30 do not react with antibodies to P30. Relations between antibodies and membrane proteins have been reported by Harning *et al.* (1996) who stated the recombinant SAG 1 antigen expressing *E. coli* can be used to allow the detection of immunoglobulin G (IgG) and IgM specific to SAG 1.

Complementary DNA is inserted in λ gt11 protein-coding genes of *Toxoplasma gondii* tachyzoite, and one of the tachyzoite protein-coding genes is a gene that encodes membrane proteins²¹. Tachyzoite of *Toxoplasma gondii* has five major surface proteins. These five major proteins include SAG1 (P30) which is the most dominant protein, SAG3 is the least amount protein, and the other three proteins are minor proteins. In addition, the third minor protein on the surface of tachyzoite is SAG1-related sequence (SRS). In such SAG1, SRS encodes proteins with glycosilphosphatidylinositol.

Seven spots of immunoblotting results obtain clones expressing membrane protein as a candidate for vaccine development and the diagnosis of toxoplasmosis. Further testing needs to be done to ensure these clones are carrying genes that encode P30 by using PCR and doing overexpression in the host Y1090. PCR results are known as long nucleotides and overexpression clones are known as molecular weight proteins encoded by these genes.

4. Conclusion

Transfection of *E. coli* Y1090 using recombinant λ gt11 obtains 7 clones carrying cDNA encoding a membrane protein of *Toxoplasma gondii* tachyzoite local isolate. Overexpression and immunoblotting results show that recombinant clones are carrying genes that encode proteins of the membrane.

Acknowledgement

Thanks for the team of grant research financed by DP3M directorate general of higher education, Indonesia, chaired by drh Sri Hartati, S.U. on good gives the author the opportunity to engage in this research project.

References

- Shulman ST, John PP, Herbert MS. *Dasar Biologi dan Klinis* (translated by A. Samik Wahab). Edisi 4. Yogyakarta: Gadjah Mada University Press; 1994.
- Frenkel JK. Transmission of Toxoplasmosis and the Role of Immunity in Limiting Transmission and Illness. *JAVMA* 1990; 196: 233-240.
- Gandahusada S. Toksoplasmosis: Epidemiologi, Patogenesis dan Diagnostik. *Kumpulan Makalah Simposium Toksoplasmosis*. Jakarta: Fakultas Kedokteran, Universitas Indonesia. 1990. p. 1-10.
- Urquhart GM, Armaour J, Duncan JL, Dunn AM, Jennings FW. *Veterinary Parasitology*. ELBS ed. England: Longman; 1988.
- Despoimier DD, Gwadz RW, Hotez PJ. *Parasitic Diseases*. 3rd ed. New York: Springer-Verlag; 1995.
- Lappin MR. Feline toxoplasmosis. *Whitham Focus* 1994; 4: 8-2.
- Henriksen P, Dietz H, Henriksen SA. Fatal Toxoplasmosis in Cats. *Vet Parasitol* 1994; 55: 20-15.
- Mohammed HO, Bowman DD, Anuar AK, Rahmah N. Evaluation of Strategies to Reduce the Risk of Congenital Toxoplasmosis: a Decision Tree Analysis Approach. *J Euk Microbiol* 1995; 41: 15S
- Robert T, Frenkel JK. Estimating Income Losses and Other Preventable Costs Caused by Congenital Toxoplasmosis in People in United States. *JAVMA* 1990; 196: 256-249.
- Wishnuwardhani SD. *Risiko Toksoplasmosis terhadap Kesehatan Reproduksi*. Kumpulan Makalah Simposium Toksoplasmosis. Jakarta: Fakultas Kedokteran, Universitas Indonesia. 1990. p. 37-45.
- Dubey JP. *Recent Advances in Neosporosis, Toxoplasmosis, and Sarcocystosis with Special Reference to Abortion in Livestock*. Precedding: 11th International Coccidiosis Conference (June). Canada: Guelph; 1993.
- Angus SO, Klivington D, Wyman J, Kovacs JA. Nucleic Acid Vaccination against *Toxoplasma gondii* in Mice. *J Euk Microbiol* 1996; 43: 117S.
- Kingsman SM, Kingsman AJ. *Genetic Engineering: An Introduction to Gen Analysis and Exploitation in Eukariotes*. Oxford: Blackwell Scientific Publications. 1988.
- Franzen C, Altfeld M, Hegener P, Hartmann P, Arendt G, Jablonowski H, Rockstroh J, Diehl V, Salzberger B, Fatkenheuer G. Limited Value of PCR for Detection of *Toxoplasma gondii* in Blood from Human Immudiciency Virus Infected Patients. *J Clin Microbiol* 1997; 35: 2641-2639.
- Angel SO, Matrajt M, Margarit J, Nigro M, Illecas E, Pzseny V, Amendocira MR, Guamera E, Garber JC. Screening for Active Toxoplasmosis in Patients by Hybridization with the ABGTg7 Probe in Blood Samples. *J Clin Microbiol* 1997; 35: 595-591.
- Joss AW, Ho-Yen DD. The Effect of Sample Storage on Polymerase Chains Reaction Based Detection of *Toxoplasma gondii* on Amniotic Fluids. *J Med Microbiol* 1997; 46: 96-92.
- Nguyen TD, De Kesel M, Bigaignon D, Hoet P, Pazzaglia G, Lammens M, Delmee M. Detection of *Toxoplasma gondii* Tachyzoites and Bradyzoite in Blood, Urin, and Brains of Infected Mice. *Clin Diag Lab Immunol* 1996; 3: 639-635.

- 336
18. Tomavo. *The Major Surface Proteins of Toxoplasma gondii of a Family: Structures and Functions* (in *Toxoplasma gondii* by Gross U). Berlin: Springer-Verlag; 1996.
 19. Grimwood J, Smith JE. *Toxoplasma gondii*: The Role of 30 kDa Surface in Host Cell Invasion. *Exp Parasitol* 1993; 74: 111-106.
 20. Bonhomme A, Boulanger F, Braradway LM, Toubas DP, Bonhomme P, Pluot M, Pinon JM. *Toxoplasma gondii*: Immunochemistry of *Pour* Immunodominant Antigens with Monoclonal Antibodies. *Exp Parasitol* 1990; 71: 451-439.
 21. Manger ID, Hehl AB, Boothroyd JC. The Surface of *Toxoplasma* is Dominated by to Glycosylphosphatidylinositol-anchored Antigen Related SAG1. *Infect Immunity* 1998; 66: 2244-2237.
 22. Artama WT. *Rekayasa Genetika*. Yogyakarta: PAU Bioteknologi Universitas Gadjah Mada; 1991.
 23. Strayer L. *Biochemistry*. 4th ed. New York: WH Freeman and Company; 1995.
 24. Freifelder D. *Molecular Biology*. Boston: Jones and Barlett Publisher Inc; 1987.
 25. Sambrook J, Fritsch EF, Maniatis T. *Molecular Cloning: A Laboratory Manual*. 2nd ed. New York: Cold Spring Harbour Laboratory Press; 1989.
 26. Kim K, Boothroyd JC. *Toxoplasma gondii*: Stable Complementation of *sag 1*(P30) Mutan using SAG 1 Transfection and Fluorescence-activated Cell Shorting. *Exp Parasitol* 1995; 80: 53-46.



Institute of Tropical
Disease
Universitas Airlangga

in a collaboration
with



Institute for Protein Research
Osaka University

Proceeding

Molecular and Cellular Life Sciences:
Infectious Diseases, Biochemistry and
Structural Biology
MCLS 2015

ISBN 978-602-14292-4-2

Contribution Bioactive Flavan-3-Ol Callus *Camellia Sinensis* As A Candidate Healing Diarrhea Disease

Sutini^{a*}, Susilowati^b, Djoko Agus Purwanto^c, M. Rasjad Indra^d

^aAgrotechnology, Department of Agriculture Faculty UPN "Veteran" East Java, Surabaya 60115, Indonesia
^bChemical Engineering Department of Industrial Technology Faculty UPN "Veteran" Surabaya 60115, Indonesia
^cDepartment of Pharmaceutical, Faculty of Pharmacy, Universitas Airlangga, Surabaya 60115, Indonesia
^dDepartment of the School Physiology, Faculty of Medical, Brawijaya University, Malang, Indonesia

Abstract

Diarrheal diseases categorized infectious and non-infectious diseases. In Indonesia diarrhea caused by viruses, parasites and bacteria such as *E. coli* is transmitted through water, food contaminated with bacteria. The purpose of this paper was to determine the contribution of bioactive flavan-3-ol as diarrhea drug candidates. Flavan-3-ol can be obtained from plants, which are harvested when reaching age five. Then developed a method of in vitro callus flavan-3-ol include: initiation of callus with *Camellia sinensis* leaf explants, isolation and identification of qualitative-quantitative test the efficacy of *E. coli*. The results of the reviews flavan-3-ol can be as diarrhea drug candidate

Keywords: *Camellia sinensis*; in vitro culture; bioactive callus flavan-3-ol.

Nomenclature

Tea	<i>Camellia sinensis</i>
MS	murashige skoog
<i>E. coli</i>	<i>Escherichia coli</i>
2,4-D	2,4-diklorofenoksiasetat acid
NAA	naftalenasetat acid

1. Introduction

In some developing countries diarrhea is still a problem¹. The disease is caused by several conditions: environment inadequate, people do not maintain hygiene habits, low education levels, low socioeconomic. The above conditions will be the cause of bakteri², viruses, parasites, infectious and non-infectious transmission media through the mouth, contaminated food and water which is a conductor for the incidence of diarrheal diseases. Associated with diarrheal disease authors conducted a study to produce callus flavan-3-ol of *Camellia sinensis* leaf is expected to be a candidate diarrheal disease prevention.

The purpose of writing paper was to determine the contribution of the bioactivity of flavan-3-ol to prevent diarrheal disease. Bioactivity flavan-3-ol produced in vitro, in the laboratory large scale. While the benefits of such bioactive paper writing flavan-3-ol has the potential to enrich the medicinal product, in an effort to prevent/treat diarrhea.

* Corresponding author. Tel.: +628123503771; fax: +62 31 8793653.
E-mail address: tien_basuki@yahoo.com

575

2. Methods

This research was conducted for one year by using ingredients: *Camellia sinensis* leaf, NaOCl, 5.25%, MS medium containing plant growth regulators NAA and 2,4-D, materials for sterilization (sterile distilled water, tween 20, agreept, alcohol 90%). Materials for extraction (hot water, chloroform, ethyl acetate). The activities consisted of several stages as follows:

308

2.1. Initiation of callus with *camellia sinensis* leaf explants

Shoots in the first position with a symmetric shape, and position of the two is used for explant cleaned using running water for thirty minutes. Shoots that have cleaned, sterilized by soaking in a solution while gently shaken 5.25% NaClO, tween-20 for 30 minutes. Rinsing with sterile distilled water, while rocked gently for 5 minutes, flushing was repeated 3 times. The leaves are sterile petri moved on, bones and edges of leaves removed and then cut into pieces the size of 0.5-1 cm. Pieces grown as much as 4-5 explants in culture bottles containing MS medium enriched with plant growth regulators (PGR) NAA and 2,4-D. Incubation of the culture bottles at room temperature 25°C, then sub cultured to multiply times callus that formed³.

574

2.2. Isolation and identification of qualitative-quantitative

Isolation and identification of qualitative-quantitative microscopy and high performance liquid chromatography (HPLC). Identification qualitatively by observation using a binocular microscope and triocular by comparing the shape of callus to form flavan-3-ol standard. Isolation performed by extraction using hot water, chloroform, ethyl acetate. Assay of callus tea extract with HPLC conditions: temperature 300°C setup, wavelength 274.8 nm, the mobile phase consisted of methanol : water : acetic acid = 20 : 75 : 5, mobile phase flow rate of 1 mL/minute⁴.

Manufacture of standard solution of flavan-3-ol by means of carefully weighed 0.5 mg flavan-3-ol standard, then dissolved in methanol and 5 mL, in order to obtain a solution with a concentration of 100 ppm as the mother liquor. From the mother liquor of 100 ppm, made a wide range of concentrations to levels 5, 10, 15, 20, and 25 ppm⁵, then each injected concentration of 100 uL on HPLC instruments with operational conditions that have been the setting, it will be obtained chromatogram. From the chromatogram created curve concentration (x) and area (y) then determined the regression line equation⁵. Samples callus tea extracts and standards flavan-3-ol dissolved in methanol sonicated for 5 minutes to remove gases contained in solution so as not to clog the column, then the solution is filtered with filter paper Whatmann 0.2 mm. To clarify the chromatogram peaks, the callus tea extract solution was added 15 ppm standard. Levels of flavan-3-ol obtained by injecting samples of 100 mL of tea callus on HPLC.

2.3. Test the efficacy of flavan-3-ol in *E. coli*

At the efficacy test (review flavan-3-ol in *E. coli*), prepared nutrient broth medium (NA) by means of a ose needle scraping containing bakteri⁶, aseptically on media tube and then covered with a cotton swab every week rejuvenated and kept at a low temperature⁷. The method is performed is agar⁸ diffusion, wherein flavan-3-ol impregnated on paper discs with a diameter of 6 mm. This paper disc placed on the surface of the media who have been inoculated bacteria *E. coli* that will tested⁹. Furthermore incubated for 24 hours at temperature 35-37°C, observed the area around the paper disc barrier¹⁰. Regional barriers formed a clear zone around the paper disc, which indicates bacterial pathogens or microorganisms that have been inhibited by the compounds tested flavan-3-ol which diffuses into the order of a paper disc. On Extraction taken with a concentration of 10% w/v, for soaking paper disc with a diameter of 6 mm¹¹. A positive response to the activity shown by the clear zone (clear zone) at about medium which has been inoculated with the bacteria *E. coli*, which is a clear zone inhibition zone conducted by flavan extracts and compounds.

3. Results and discussion

Callus results of this study will be tested efikasikan in *E. coli* but in this article efficacy test are still reviewing the results of other studies researchers as written in the following chapters.

308

3.1. Initiation of callus with *camellia sinensis* leaf explants

Results tea callus initiation in vitro with plant growth regulators NAA and 2,4-D and using media MS at the age of 4 weeks to 12 weeks of age¹², the response callus growth can be seen in Fig. 1.

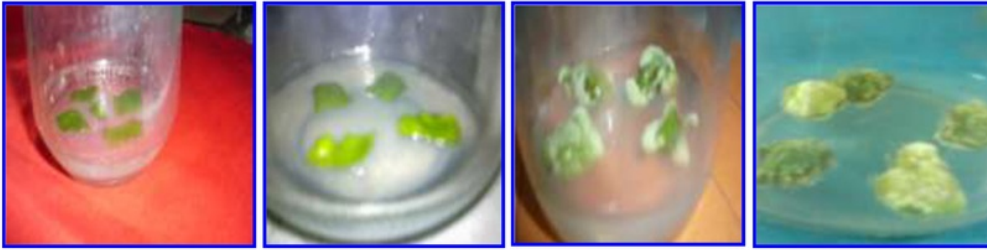

Fig. 1. Callus growth response with growth regulator 2-4 D and NAA

In Fig. 1, appears morphological changes from left to the right to successive leaf explants with the width of approximately one centimeter which turned into a frown, bulging, writhing then appears callus that is started from the edge of next explants formed callus that meet all explants. This research is relevant to Iriawati¹³ that the use of in vitro culture methods that can successfully reproduce callus that induce alkaloid secondary metabolites as well as induce somatic embryo of the plant earth peg (*Eurycoma longifolia* Jack). Research conducted by Parthraj¹⁴ is also mentioned that callus can be induced through this in vitro culture with MS media and on the plant growth regulator substances Swertia lawii Burkill.

3.2. Isolation and Qualitative-Quantitative Identification

Isolation and qualitative identification is by using HPLC chromatogram can be seen in the area and retention time of flavan-3-ol¹⁵ as described in Fig. 2 and 3.

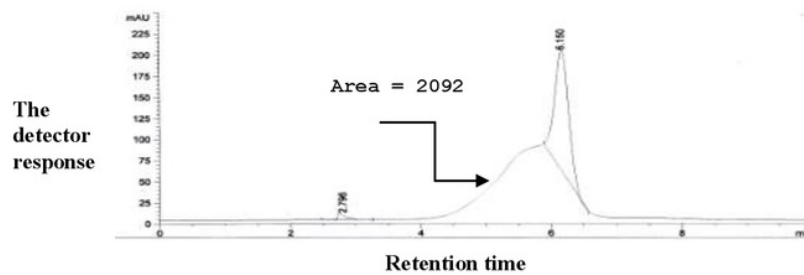

Fig. 2. Chromatograms area standard flavan-3-ol-catechol

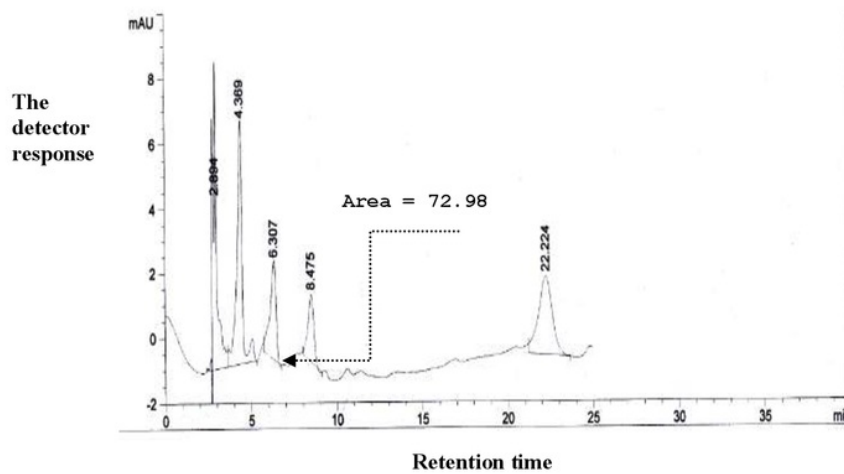

Fig. 3. Retention time of flavan-3-ol

Quantitative identification by calculating the levels of flavan-3-ol calculated as ratio of the chromatogram area samples and standards that follow the method of Mustafa¹⁶ levels obtained the level of flavan-3-ol at 3:48 ppm. This research is relevant to the research of Dakah¹⁷ who produce polyphenols successfully through in vitro culture *Ziziphora tenuior* L. that can be used for anti-oxidants.

3.3. Callus form observation using a binocular microscope

Callus form observation using a binocular microscope as described in Fig. 4 in which the form and the part of callus color is similar to a standard form of flavan-3-ol-cathecol.

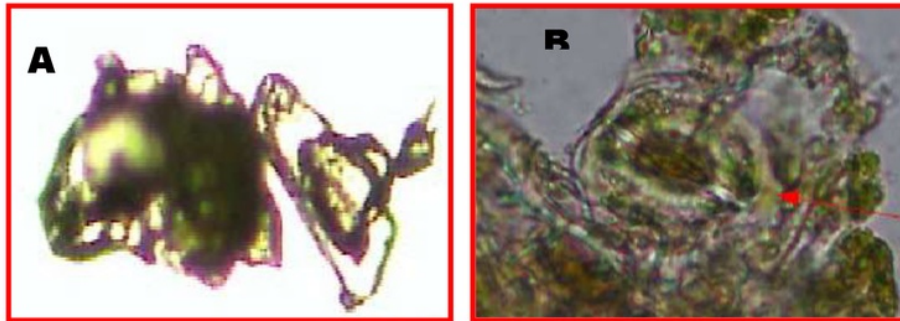

Fig. 4. Observation using a binocular microscope, magnification 10 X: standard form of flavan-3-ol-cathecol (A), and Callus form (B)

Fig. 4 shows the similarity of the shape and color of callus with standard. This case indicates that bioactive flavan-3-ol-cathecol can be produced through callus culture.

3.4. Callus cell observation using a triokuler microscope

Callus cell observation using a triokuler microscope like those in Fig. 5 which is similar to the standard of callus flavan-3-ol-polyphenol.



Fig. 5. Callus cell observation using a triokuler microscope magnification 400x : the form of standard flavan-3-ol-polyphenols (A) and Callus cell flavan-3-ol-polyphenol arrow (B)

Fig. 4 and 5 show the form of cell that is similar to standard cell shape which indicates callus that contains bioactive metabolites flavan-3-ol but it also appears the form of callus which is considered to form an embryo. The embryonic form is same with the research of Lü¹⁸ that the in vitro culture of *Camellia nitidissima* Chi (Theaceae) forms somatic embryos.

3.5. Efficacy test flavan-3-ol on *E. coli*

Test the efficacy of flavan-3-ol / polyphenols from tea leaves concentration of 500 mg can inhibit the growth of *E. coli* bacteria (strain ATCC 25 922) 5000 mg/mL. Bacteria inhibition of growth can be seen in Fig. 6.

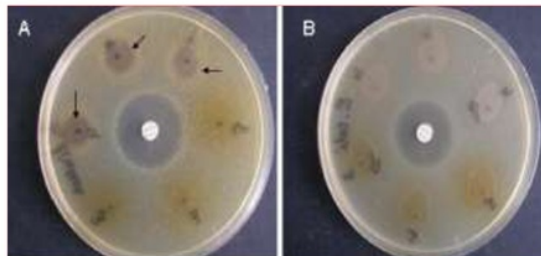

Fig. 6. Response activities *E. coli* bacteria (A) indicated positive arrows/clear zone. (B) negative no clear zone¹⁹.

Research conducted by Hoshino that test the efficacy of flavan-3-ol / catechin and catechin-Cu complex can penetrate and damage the cell surface lipopolysaccharide *E. coli* seen in the illustration Fig. 7.

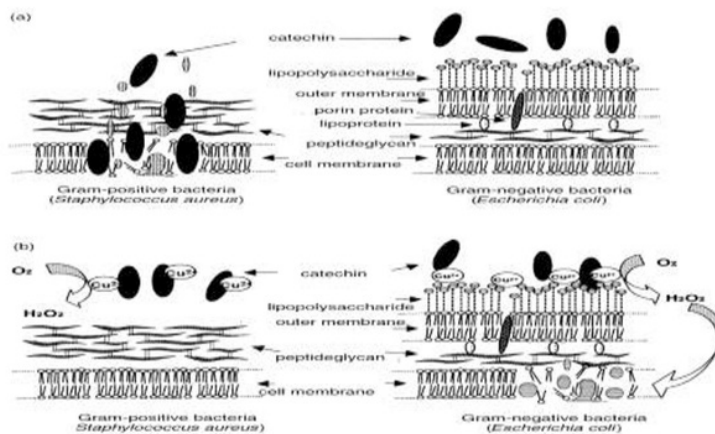

Fig. 7. Mechanism of flavan-3-ol / catechin and complex Cu catechin-penetrate and damage the cell surface lipopolysaccharide *E. coli* (Hoshino²⁰).

4. Conclusion

Flavan-3-ol can be produced by in vitro culture methods using PGR 2-4D and acquired NAA levels of flavan-3-ol 348 ppm²¹. Flavan-3-ol/polyphenols from tea leaves concentration of 500 mg can inhibit the growth of *E. coli* bacteria (strain ATCC 25 922) 5000 mg/mL¹⁹.

261

Acknowledgements

The gratitude goes to General Directorate of Higher Education and National Department of Education Indonesian for funding of this research.

References

1. Jones ACC, Farthing MJG. Management of infectious diarrhoea. *J. Gut* 2004; 53:296-305. 278
2. Adyanstri F. Etiologi dan gambaran klinis diare akut di RSUP Dr Kariadi Semarang. Skripsi. Program pendidikan sarjana kedokteran Fakultas kedokteran Universitas diponegoro. 2012. 86
3. Sutini, Tatik W, Wahyu W, S.B. Sumitro. Metode produksi flavan-3-ol melalui kalus *Camellia sinensis* L: dengan elisitor Cu²⁺. *J. Berk. Penel. Hayati* 2008; 14 :39-44.
4. Karlina. Penetapan Kadar Epigallocatechin Gallate (EGCG) Dalam Daun Teh Dengan Metode KCKT, Skripsi. Fakultas Farmasi Unair. Surabaya. 2006.

5. Sutini. Produksi *Flavan-3-ol* Melalui kultur *Camellia sinensis* L : dengan induksi elisitor: cu^{2+} , asam salisilat dan fenilalanin. Program studi ilmu-ilmu pertanian. Minat bioteknologi Universitas Brawijaya Program Pascasarjana. Malang. 2009.
6. Rustanti, E. Uji efektivitas antibakteri dan identifikasi senyawa katekin hasil isolasi dari daun teh (*Camellia sinensis* L. var. *Assamica*). Skripsi. Fakultas Sains dan Teknologi. Jurusan kimia. Universitas Islam Negeri (UIN) Malang. 2009.
7. Kumar, A, Patil S, Sharma P. Antibacterial activity of green tea (*Camellia sinensis*) extracts against various bacteria isolated from environmental sources. *J. Recent Research in Science and Technology* 2012; 4: 2076-506.
8. Ahmad, I, Aqil F. In vitro efficacy of bioactive extracts of 15 medicinal plants against ESBL-producing multidrug-resistant enteric bacteria. *J. Microbiological Research* 2007; 162: 264—275.
9. Noormandi A., Dabaghzadeh F. Effects of green tea on *Escherichia coli* as a uropathogen. *J. Traditional and Complementary Medicine*. 2015; 5: 15-20.
10. Gahlaut A., Dabur R. Proteomic Analysis Of *Escherichia Coli* In Response To Catechins Rich Fraction. *Pharmacy and Pharmaceutical Sciences*. 201 ; 6 : 784-787.
11. Veronica S C., Braicu C, Chirila F. Antibacterial action of an aqueous grape seed polyphenolic extract. *J. Biotechnology*. 2011;33: 6276-6280.
12. Sutini. Pengembangan Produksi Flavan-3-Ol Melalui Kultur Suspensi Sel *Camelli Sinensis* L : Untuk Penghambatan Diferensiasi Sel Adiposa. Laporan tahunan Hibah penelitian kompetensi. Universitas Pembangunan Nasional “Veteran” Jatim. 2013.
13. Iriawati, Rahmawati A. Rizkita R. E. Analysis of Secondary Metabolite Production in Somatic Embryo of Pasak Bumi (*Eurycoma longifolia* Jack). *Procedia Chemistry*. 2014; 13:112 – 118.
14. Parthraj R.K., Jaykumar J.C., Suraj D.U. Highly efficient in vitro regeneration, establishment of callus and cell suspension cultures and RAPD analysis of regenerants of *Swertia lawii* Burkill. *J. Biotechnology Reports*. 2015; 6:79–84.
15. Sutini. Pengembangan Produksi Flavan-3-Ol Melalui Kultur Suspensi Sel *Camelli Sinensis* L : Untuk Penghambatan Diferensiasi Sel Adiposa. Laporan tahunan Hibah penelitian kompetensi. Universitas Pembangunan Nasional “Veteran” Jatim. 2014.
16. Mustafa R.A. Total phenolic compounds flavonoids 21 plants. *Journal of Food science*. 2010. 75
17. Dakah A., Zaid S., Suleiman M. In vitro propagation of the medicinal plant *Ziziphora tenuior* L. and evaluation of its antioxidant activity. *Saudi Journal of Biological Sciences*. 2014; 21: 317–323.
18. Lü J., Chen R., Zhang M. Functional biotechnology Plant regeneration via somatic embryogenesis and shoot organogenesis from immature cotyledons of *Camellia nitidissima* Chi. *Journal of Plant Physiology* 2013; 170:1202– 1211.
19. Cho Y, Schiller NL, Kahng HY, Oh KH. Cellular responses and proteomic analysis of *Escherichia coli* exposed to green tea polyphenols. *J. Curr Microbiol*. 2007;55: 501-506.
20. Hoshino N., Kimura T., Hayakawa F A. Bactericidal activity of catechin-copper (II) complexes against *Staphylococcus aureus* compared with *Escherichia coli*. *J. Letters in Applied Microbiology*. 2000; 31:213-217.
21. Sutini. Pengembangan Produksi Flavan-3-Ol Melalui Kultur Suspensi Sel *Camelli Sinensis* L : Untuk Penghambatan Diferensiasi Sel Adiposa. Laporan tahunan Hibah penelitian kompetensi. Universitas Pembangunan Nasional “Veteran” Jatim. 2014.



Institute of Tropical
Disease
Universitas Airlangga

in a collaboration
with



Institute for Protein Research
Osaka University

Proceeding

Molecular and Cellular Life Sciences:
Infectious Diseases, Biochemistry and
Structural Biology
MCLS 2015

ISBN 978-602-14292-4-2

In Vitro Antimalarial Activity of Ethanol and Methanol Extract *Carthamus tinctorius* L

Rini Hamsidi^{a*}, Nur Illiyyin Akib^a, Wahyuni^a

^aFaculty of Pharmacy, Halu Oleo University, Kendari, Southeast Sulawesi 97231, Indonesia

Abstract

The extracts ethanol and methanol from *Carthamus tinctorius* L. flowers showed the inhibition against *Plasmodium falciparum* 3D7 clone. Ethanol extract had the highest inhibition of 95.97% with IC₅₀ 1.06 µg/mL compared to an untreated control, while methanol extract had inhibition of 62.39% with IC₅₀ 15.89 µg/mL. Extracts of ethanol and methanol were obtained through maceration for 3x24 hours. The antimalarial activities of the extract were determined by the procedure described by Budimulya *et al.* Stock solution of the samples were prepared in DMSO and were diluted to the required concentration with complete medium until the final concentration of samples at well culture plate were : 100; 10; 1; 0.1; 0.01 µg/mL. The malarial parasite *P. falciparum* 3D7 clone was propagated in a 24-well culture plate in the presence of a wide range of concentrations of each compound. The antimalarial activity of each compound was expressed as an IC₅₀ value, defined as the concentration of the compound causing 50% inhibition of parasite growth relative to an untreated control. The result showed that ethanol extract deserved further investigation toward development of a promising antimalarial drug.

Keywords: Antimalarial activity, In vitro, *Plasmodium falciparum* 3D7, *Carthamus tinctorius* L.

1. Introduction

572

Malaria is an infectious disease caused by protozoa of the genus *Plasmodium*. This disease contributes to the high rate of mortality among infants, under-five children, and pregnant women. Annually, more than 500 people worldwide are infected by malaria and 1 million died because of this disease. The majority of malarial cases occur in Africa, as well as in several countries in Asia, South America, Middle East, and Europe. To deal with the disease, the 60th meeting of World Health Assembly (WHA) has come up with a global commitment on the elimination of malaria in all countries. Guidance on how to go about doing this has been provided by the World Health Organization (WHO) through its *Global Malaria Program*¹.

Indonesia is one of the countries at the risk of malaria. Most of Indonesian regions are malaria-endemic, in particular the eastern part of the country including Papua, Maluku, Nusa Tenggara, Sulawesi, and Kalimantan, as well as some areas in Lampung, Bengkulu, and Riau. In some areas of Java and Bali, despite low endemism, cases of malaria outbreaks still occur frequently. In 2007, 396 out of 495 regencies in Indonesia are malaria-endemic, and it was estimated that 45% of the population live in areas that are at high risk of malaria infection. In addition, malaria morbidity in the country is reported to rise from year to year. To overcome malaria disease, various efforts have been made both in global and national scale. Malaria is one of indicators of Millennium Development Goals (MDGs), with an aim at putting a stop to the spread of malaria and reducing malaria-related incidents in 2015, to be indicated by a decrease in morbidity and mortality caused by malaria².

One factor leading to some problems faced in the eradication of malaria is a decrease in the efficacy of antimalarial drugs that have commonly been taken. *Plasmodium falciparum* has been reported to be resistant to antimalarial *chloroquine*. Reports also indicate that resistance to *chloroquine*, *sulfadoxine-primetamin*, *mefloquine*, *halofantrin*, and *quinine* occur in some areas in Southeast Asia. In certain areas within the region, a combination of *artemisinin* and its derivatives is the only effective medication³. Other factors leading to the still high rate of morbidity and mortality include large-scale human migration, environmental and climate change, poor healthcare system, and the emergence of strains of insecticide-resistant *Anopheles* mosquitos⁴.

* Corresponding author. Tel.: -; fax: -;
E-mail address: rinihamsidi@gmail.com

An alternative way of preventing malaria is by developing a concept of immunotherapy medication, that is, an administration of drugs in the forms of either synthetic or natural compounds (plants) that are capable of optimizing the functions of all components in human body immune system to combat malarial infection. Immunity to malarial infection involves cellular and humoral responses. A cellular immune response is mediated by T. lymphocytes, which plays an important role in the fight against the infection from intracellular sporozoites (skizogoni extra-erythrocytic).

Kasumba turate (*Carthamus tinctorius* Linn) flower from the Asteraceae family has empirically been used as traditional medication by people in South Sulawesi to heal measles by brewing the plant in hot water before taking its juice, the consumption of which is believed to help increase body's immunity system. A study on the ethanol extract of kasumba turate discovered that the extract highly significantly increases both immunoglobulin G (IgG) and A (IgA) activities. Dried flowers of this plant can also be used as emmenagogue, laxant, or stimulant. In addition to consumption, its seed oil is used in mixture of cosmetic materials⁵. When tested on mice to determine its cellular immune response, the immunomodulatory effect of juice extracted from kasumba turate flower (*Carthamus tinctorius* Linn) was remarkably significant. A test on nonspecific immune response showed that a dosage of 1.95 and 3.90 mg/kg bodyweight could increase phagocytosis speed, as was indicated by the phagocytosis index: 1.72 and 1.88 ($K > 1.5$), and this was considered as a strong immunostimulation. This increases very significantly when the flower is brewed with hot water⁶.

Based on the immunomodulatory activity exhibited by kasumba turate flower (*Carthamus tinctorius* Linn), it is of interest to find out whether ethanolic and methanolic extract from kasumba turate flower (*Carthamus tinctorius* Linn), which have been known to function as an immunomodulator, could also increase the activity of immunocompetent cells that play important roles in developing body's defense against malarial infection. This interest is worth pursuing, since it is important to build a scientific ground upon which kasumba turate (*Carthamus tinctorius* Linn) can be justifiably developed as malarial immunotherapy.

2. Methods

2.1 Plant Material

Flowers of kasumba turate (*Carthamus tinctorius* Linn) were collected from Bone, a regency in South Sulawesi, and have previously been determined by Purwodadi's LIPI in Pasuruan.

2.2 Extraction

The flowers of kasumba turate (*Carthamus tinctorius* Linn) were ground into powder before they were divided into two parts, each weighed 300 grams. Simplicia powder was macerated in ethanolic and methanolic liquid for 3 x 24 hours. The filtrates were collected and evaporated by using evaporator, reducing pressure until thick extract was obtained.

The powder extracted from the flowers of kasumba turate (*Carthamus tinctorius* Linn) was macerated in ethanolic and methanolic liquid. Two hundred and fifty grams of the powder of kasumba turate flower were extracted by using methanol, resulting in 23.32 grams of thick yellow-brownish methanolic extract with 9.33% of yield, whereas one hundred and twenty-five grams of kasumba turate flowers powder was dissolved in ethanolic liquid, resulting in 20.48 grams of thick yellow-brownish ethanolic extract with 16.38% of yield.

334

2.3 In Vitro Antimalarial Activity Assay

The antimalarial activities of the extract were determined by the procedure described by Budimulya *et al*⁷. Breeding is done in a petri-dish and done aseptically. Plasmodium falciparum 3D7 culture obtained from frozen deposits in-thawing and bred. After culturing Plasmodium falciparum synchronized then be tested as follows: Material testing ethanol and methanol extracts *C. tinctorius* L flowers dissolved in DMSO and sterile filtered with a membrane filter of 0.22 μ m. This test solution is then inserted into the microplate that contains the parasite suspension to the level of 1% parasitaemia then diluted in series with a medium until obtained final concentration of test substance in the microplate as follows: 100; 10; 1.0; 0.1 and 0.01 mg/mL. Negative controls used DMSO diluted in the same manner as diluting materials above test, in order to obtain final DMSO concentration is not more than 0.5%. Mixture and suspension test parasites (test preparation) is then inserted into the candle-jar and incubated in a CO₂ incubator at a temperature of 37°C for 48 hours. After incubation for 48 hours, made thin blood smear on glass object. Smear dried at room temperature, fixed with methanol, then once dry stained with Giemsa and counted under a microscope parasitemianya with 1000 times magnification. Calculations performed on 5000's erythrocytes.

3. Data Analysis

The data obtained from in vitro antimalarial activities assay above is in the form of number of parasite-infected erythrocytes (counted on around 5000 erythrocytes) were subsequently converted into parasitemia levels (percent parasitaemia) and the percent inhibition of the test substance on the growth of the parasite.

Percent parasitaemia calculated by the formula:

$$\% \text{ Parasitemia} = \frac{\Sigma \text{ infected erythrocytes}}{\text{The number of erythrocytes}}$$

The percentage inhibition of parasite growth is calculated using the formula:

$$\% \text{ Inhibition} = 100\% - \left(\frac{X_p}{X_k} \right) \times 100\%$$

Based on the data about the inhibition and concentration of the tested materials, IC_{50} , or the concentration of test materials that inhibit parasite growth by 50%, were then calculated by using the probity analysis.

4. Results and discussion

Methanolic extracts of kasumbaturate flower. Results of this test can be seen on the table and figure below. As can be seen, ethanolic and methanolic extracts had an inhibitory power over the growth of *Plasmodium falciparum* 3D7. The test on 100 $\mu\text{g/mL}$ concentration show that, compared to the negative control, the inhibitory power of ethanolic and methanolic extracts were 95.97% and 62.39% respectively. This inhibitory power reduced as tested concentration was also reduced, indicating that the inhibitory power of ethanolic and methanolic extracts depend on concentration.

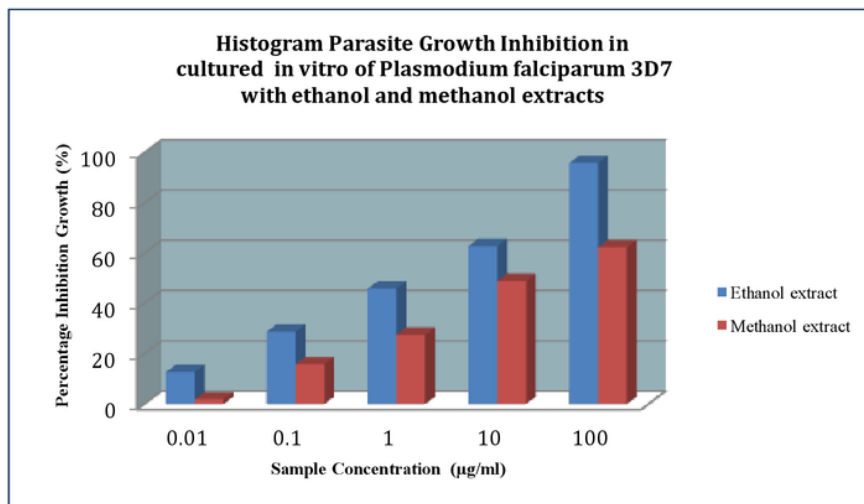

Fig. 1. Histogram parasite growth inhibition in cultured in vitro *Plasmodium falciparum* 3D7 clone of ethanol and methanol extracts with variation concentrations.

To determine the potential growth inhibition of ethanolic extract, methanolic extract, and water extract, IC_{50} values were calculated by using probity analysis. The results of this analysis were presented on the following table.

Extract	Growth inhibition at variation of doses ($\mu\text{g/mL}$)					IC_{50} ($\mu\text{g/mL}$)
	100	10	1	0.1	0.01	
Ethanol extract	95.97	62.85	45.95	28.78	12.68	1.06
Methanol extract	62.39	48.94	27.61	15.79	1.77	15.89

According to Kohler (2002), an extract whose IC₅₀ value is lower than 50 (µg/mL) and a fraction whose IC₅₀ value is lower than 25 (µg/mL) are considered effective antimalarials. Data on the table above show that the IC₅₀ values of both ethanolic and methanolic extract are lower than Kohler's criteria. It can therefore be stated that the extracts of ethanol and methanol can serve as effective antimalarials. However, since the IC₅₀ value of ethanolic extract is lower than that of methanolic extract, it can be concluded that ethanol has a more potential antimalarial activity than does methanol. Therefore, it is necessary to isolate the flower of kasumba turate (*Carthamus tinctorius* Linn) according to the *bioassay guided isolation* principle in order to obtain active compounds that can be used as a marker in the standardization of antimalarial materials, so that flowers of kasumba turate can be developed into phytopharmaca products.

267

Acknowledgements

I would like to express my deep acknowledgements to Prof. Dr. Sahidin, M.Si., as a dean of Faculty of Pharmacy, Halu Oleo University for the research grant for young researcher in Faculty of Pharmacy.

481

References

1. World Health Organization. *World Malaria Report*. 2010; Page: 32-33.
2. Kepmenkes RI. Epidemiologi malaria di Indonesia. *Buletin Jendela Data dan Informasi Kesehatan*. 2011; hlm 7-8.
3. Waters, Andy and Janse, Cehris. 2005. Drug-Resistant Malaria. Atlanta: Leiden University Medical Center.
4. Ekasari. 2010. Identification of biochemical targets of antimalarial compounds isolated leaf *Cassia siamea* Lamk. *Dissertation*. Indonesia. Universitas Airlangga. 291
5. Usmar, Syukur R, Tayeb Rosany, Abdullah Nurlaila. Uji aktivitas imunomodulator Kasumba turate (*Carthamus tinctorius* Linn) sebagai upaya pembuatan sediaan terstandar menuju prototipe skala Industri Kecil. *Majalah Farmasi dan Farmakologi*. 2010; Vol. 14 No. 1 Maret 2010 (ISSN: 1410-7031) hal 19. 108
6. Pakki Ermina, Usmar dan Syukur Rahmawati. Formulasi dan uji stabilitas sediaan minuman Herbal Imunomodulator Berbasis Rumpun laut. *Majalah Farmasi dan Farmakologi* Vol. 15 No. 1.
7. Ekasari. Antimalarial activity of Cassiarin A from the Leaves of *Cassia siamea*. *HETEROCYCLE*. 2009; Vol.78, No.7.



Institute of Tropical
Disease
Universitas Airlangga

in a collaboration
with



Institute for Protein Research
Osaka University

Proceeding

Molecular and Cellular Life Sciences:
Infectious Diseases, Biochemistry and
Structural Biology
MCLS 2015

ISBN 978-602-14292-4-2

Vanillin Production from Lignocellulosic Extract of Oil Palm Empty Fruit Bunch Fiber (OPEFBF) by *Pycnoporus cinnabarinus*

Pei-Ling Tang^a, Osman Hassan^{a*}, Khairiah Badri^b, Mohamad Yusof Maskat^a

^aFood Science Program, School of Chemical Sciences and Food Technology, Faculty of Science and Technology, The National University of Malaysia, 43600 UKM Bangi, Selangor, Malaysia.

^bPolymer Research Center (PORCE), Faculty of Science and Technology, The National University of Malaysia, 43600 UKM Bangi, Selangor, Malaysia.

Abstract

This study was conducted to produce vanillin via fermentation by *Pycnoporus cinnabarinus* MUCL 39533 on lignocellulosic extract of oil palm empty fruit bunch fiber (OPEFBF). Lignocellulosic extract of OPEFBF was obtained by treating 10% wt. (*db*) of OPEFBF with 50 g L⁻¹ sodium hydroxide at 120°C for 2 hours. Soluble lignin in the extract was recovered through acidification, centrifugation and drying. About 21.87±3.44 gram of lignin had recovered from each liter of extract. The obtained dried lignin fragment and phenolic-rich black liquor was then fed to *P. cinnabarinus* separately for vanillin production through fermentation. Based on the results obtained, vanillin production was only achieved with the fed of lignin. With the presence of cellobiose and resin Amberlite XAD4, about 0.65±0.08 mg of vanillin was successfully yielded from 1 gram of lignin. The overall bioconversion process that developed in this study successfully produced 0.15 g of vanillin from each kg of OPEFBF.

Keywords: Black liquor; fermentation; lignin; oil palm empty fruit bunch fiber (OPEFBF), vanillin.

Nomenclature

OPEFBF	Oil Palm Empty Fruit Bunch Fiber	ppm	part per million
HPLC	High Performance Liquid Chromatography	g L ⁻¹	gram per liter
<i>db</i>	dry basis	rpm	revolutions per minute
%wt.	percentage weight/weight		

1. Introduction

Concept of waste to wealth has been promoted in Malaysia since late 1990, to convert unwanted agricultural waste into value added product/chemicals, while reducing waste generation and improve environmental sustainability¹. Under 10th Malaysia Plan (2011-2015), oil palm industry and oil palm-related products was identified as one of the National Key Economy Area (NKEA) to chart the country development towards a high income nation. To achieve this mission, initiative has taken to develop palm oil industrial clusters (POIC) into integrated sites for promoting downstream activities such as production of biofuel, oleochemicals, specialty food products, pharmaceuticals and other products².

Among various oil palm wastes, empty fruit bunch fiber (EFBF) is the most abundant biomass³. Therefore, EFBF has been selected as the targeted substrate in this study. Moreover, in order to maximize the efficiency of biorefinery, the recovery of lignin and aromatic compounds from the generated black liquor was focused. Untreated black liquor from oil extraction is a major agricultural pollutant of oil palm industry. Black liquor is a complex aqueous solution comprised of organic components such as lignin, carbohydrate fragments, low molecular weight resin and other phenolics as a valuable resource from the treated biomass and inorganic

* Corresponding author. Tel.: +6-038-921-3805; fax: +6-038-921-3232.
E-mail address: osman@ukm.edu.my

component such as ion salt⁴. Several studies had reported the production of vanillin from lignin and its derived aromatic compounds such as ferulic acid via either chemical or biotechnological means^{5,6,7,8,22}.

Vanillin (4-hydroxy-3-methoxybenzaldehyde) is an aromatic flavoring compound widely used in food, pharmaceutical and cosmetic industry. Nonetheless, due to the low yield and high cost of natural vanillin extraction from *Vanilla sp.* orchid, the current vanillin demands have to fulfill by synthetic vanillin. However, according to EU and US legislation, vanillin synthesized from natural resource through biotechnological means can be labeled as natural vanillin⁹. With this in mind, the successful biotransformation of lignocellulosic extract of EFBF into vanillin via fermentation not only will broaden the EFBF utilization, but also increases the revenues of biorefinery process of oil palm industry.

In this study, efficiency of vanillin production via fermentation by *Pycnoporus cinnabarinus* was compared between the different feeding rate of recovered lignin and black liquor obtained after alkaline treatment of EFBF. In addition, the effects of resin Amberlite XAD4, cellobiose and its combination on the yield of vanillin from fermentation were also studied.

2. Methods

2.1 Materials

Oil palm empty fruit bunch fiber (OPEFBF) obtained from Seri Ulu Langat Sdn. Bhd., Dengkil, Selangor, Malaysia was used as the substrate of this study. The fresh OPEFBF was washed, and then sun-dried until moisture content reached at approximately 10-11% wt. (*db*). The dried OPEFBF was then cut into size 5-8 cm, and kept refrigerated at 4°C until further usage. Strain of *Pycnoporus cinnabarinus* MCUL 39533 was purchased from BCCM/MUCL (Agro) Industrial Fungi & Yeast Collection, Belgium. The strain was maintained on malt extract slant agar containing 20 g L⁻¹ malt extract and 15 g L⁻¹ agar at 4°C. Other chemicals used included sodium hydroxide,

HPLC grade methanol, magnesium sulfate, dipotassium hydrogen phosphate, calcium chloride (Merck, Germany), vanillin, D-(+)-maltose monohydrate, diammonium tartrate, yeast extract (Sigma Aldrich, USA) etc. All chemicals were analytical grade and obtained from commercial source.

2.2 Methods

The OPEFBF treatment was carried out by soaking 10% wt. of OPEFBF into 50 g L⁻¹ sodium hydroxide solution. The reaction was conducted at 120°C for 120 minutes in an autoclave. The black liquor generated after treatment was separated from the treated OPEFBF through vacuum filtration by using muslin cloth. pH of the recovered black liquor was adjusted to pH 5 by using concentrated sulphuric acid, and then autoclaved at 121°C for 15 minutes. This sterile black liquor was then served as the feeding substrate of the fermentation. For lignin preparation, the collected black liquor was adjusted to pH 2, and then centrifuged at 10000 rpm for 10 minutes using centrifuge Eppendorf 5804 (Hamburg, Germany). The lignin pellet was oven-dried at 105°C overnight. The dried lignin fragment was crushed and ground into fine powder using mortar and pestle. The ready-to-use lignin powder was kept in a tight capped bottle at room temperature until further usage^{10,11}.

P. cinnabarinus culture was grown in 100 mL basal medium containing 50 g L⁻¹ glucose, 1.842 g L⁻¹ diammonium tartrate, 5 g L⁻¹ yeast extract, 0.2 g L⁻¹ potassium dihydrogen phosphate, 0.0132 g L⁻¹ calcium chloride and 0.5 g L⁻¹ magnesium sulphate at 30°C and pH 5 with 150 rpm agitation for 10 days¹². Then, the mycelium was ground with Waring blender and the cell concentration was determined. Mycelium suspension with dried cell weight at 6-7 mg cell mL⁻¹ suspension was prepared. About 2 mL of mycelium suspension was inoculated into 100 mL basal medium containing 20 g L⁻¹ maltose, 1.842 g L⁻¹ diammonium tartrate, 0.5 g L⁻¹ yeast extract, 0.2 g L⁻¹ potassium dihydrogen phosphate, 0.0132 g L⁻¹ calcium chloride and 0.5 g L⁻¹ magnesium sulphate at pH 5, and incubated at 30°C with 150 rpm agitation. After 3 days incubation, about 10 mL of black liquor and 1 g of sterile lignin powder was aseptically inoculated into the medium respectively. Sampling started at day 4 and the fermentation ended on day 5. Effect of the presence of resin Amberlite XDA4 and cellobiose on vanillin yield during fermentation were also studied. Either 2 g of resin Amberlite XAD4 or 2 mL of 0.05 mg mL⁻¹ cellobiose or both was added into the fermentation medium an hour before feeding respectively^{13,14}. Vanillin adsorbed onto the resin Amberlite XAD4 was recovered by addition of methanol during regeneration of the resin. Vanillin yield is the sum of free vanillin presence in the medium and the recovered vanillin from resin Amberlite XAD4 after fermentation. The analysis of vanillin was conducted using HPLC¹⁰.

3. Results and discussion

Initially, the yield of total recovered lignin, vanillin and vanillin precursors, included vanillic acid and ferulic acid presence in the black liquor were quantified. Based on the results obtained, about 21.87±3.44 gram of lignin was recovered from each liter of produced black liquor and 11.46 ppm vanillic acid, 16.61 ppm vanillin and

35.66 ppm ferulic acid was detected. During alkaline treatment, hydroxide anions cleaved the α - and β -aryl ether bonds in the lignin network. As consequences, lignin polymer became fragmented into smaller water/alkaline-soluble fragments. The lignin fragmentation process continued with the cleavage of linkages that holds the phenylpropane units, and thus additional free phenolic hydroxyl group generated¹⁵. Under alkaline condition, alkaline labile ester bond which linked hydroxycinnamic acid such as ferulic acid within the lignin-hemicellulose network cleaved, and free ferulic acid released into the black liquor¹⁶. Besides, free ferulic acid also tends to further oxidized to vanillin and vanillic acid in the alkaline medium¹⁷. Therefore, quantification of vanillin, vanillic acid and ferulic acid content in black liquor prior feeding is necessary to avoid over-estimation of fermentation efficiency of *P. cinnabarinus* in black liquor. Results of the *P. cinnabarinus* fermentation on lignin and black liquor were showed in Table 1.

Table 1. Vanillin yield from the fermentation of lignin and black liquor from OPEFBF by *P. cinnabarinus* ($p < 0.05$; $n = 3$).

Compounds	Lignin			Black liquor		
	Before feeding (ppm)	After feeding (ppm)		Before feeding (ppm)	After feeding (ppm)	
		Day 4	Day 5		Day 4	Day 5
Vanillin	n.d	2.64±0.07 ^a	2.53±0.34 ^a	16.61	7.06±0.55 ^a	10.46±0.29 ^b
Vanillic acid	n.d	2.56±0.22	<0.00	11.46	10.99±0.55 ^a	13.63±1.34 ^b
Ferulic acid	n.d	<0.00	<0.00	4.08	15.20±0.44 ^a	22.08±1.23 ^b

Note: a-b : Different alphabets in the same row indicated that there are significant differences ($p < 0.05$) between the yield of the compounds from different day of fermentation.
n.d : represents not detected.

The presented results clearly indicated that the recovered lignin was a better substrate than black liquor in *P. cinnabarinus* fermentation for vanillin production. Fermentation of black liquor by *P. cinnabarinus* did not improve the vanillin content. On the contrary, it reduced the yield of initially present vanillin and ferulic acid significantly ($p < 0.05$). Consumption of ferulic acid did not productively transform into vanillin by *P. cinnabarinus*. Therefore, we strongly suspected that the presence of series of aromatic compounds in the black liquor exerted some degree of inhibition in the metabolic pathway of *P. cinnabarinus* during fermentation. Content of both ferulic acid (substrate) and vanillin (product) in the fermentation medium affected the productivity and yield of products. Accumulation of end product of its biochemical pathway stops the synthesis of vanillin, while other compounds, such as vanillyl alcohol and vanillic acid, will be generated¹⁸. Thus, this explained the reason why the yield of vanillic acid had increase on day 5 fermentation. In addition, slight increase of ferulic acid on day 5 fermentation might be due to the release of ferulic acid from lignin present in the black liquor. Absence of the vanillin/vanillic acid/ferulic acid in the medium at the early stage fermentation prevents the end product inhibition to occur with the feeding of lignin.

Due to the superior potential of lignin in vanillin production, further study on the improvement of vanillin yield from OPEFBF was conducted by using lignin as the fermentation substrate. Table 2 showed the vanillin yield from the lignin fermentation by *P. cinnabarinus* in the presence of resin Amberlite XAD4, cellobiose and both resin and cellobiose respectively.

Table 2. Comparison of vanillin yield from lignin fermentation by *Pycnoporus cinnabarinus* in the presence of resin Amberlite XAD-4, cellobiose and both resin and cellobiose respectively ($p < 0.05$; $n = 3$).

Fermentation setting	Vanillin yield			
	Day 4		Day 5	
	ppm	mg g ⁻¹ lignin	ppm	mg g ⁻¹ lignin
Resin only	5.30±0.27 ^{Ac}	0.53±0.03 ^{Ac}	5.08±0.08 ^{Ab}	0.51±0.01 ^{Ab}
Cellobiose only	2.67±0.23 ^{Aa}	0.27±0.02 ^{Aa}	2.87±0.10 ^{Aa}	0.29±0.01 ^{Aa}
Resin + Cellobiose	3.25±0.28 ^{Aa}	0.33±0.03 ^{Aa}	6.50±0.75 ^{Bc}	0.65±0.08 ^{Bc}

Note: a-c : Different alphabets in the same column indicated that there are significant differences ($p < 0.05$) between the yield of vanillin from different fermentation setting.

A-B: Different alphabets in the same row indicated that there are significant differences ($p < 0.05$) between the yield of vanillin from different day of fermentation.

Based on the results obtained, it was demonstrated that the highest yield of vanillin was achieved in the fermentation with the presence of both resin Amberlite XAD4 and cellobiose. The vanillin yield was increased by 2.6-fold, compared to the lignin-fed fermentation. During *P. cinnabarinus* fermentation, vanillic acid was produced from ferulic acid via ferulic acid propenoic chain degradation. With the presence of cellobiose, vanillic acid metabolism of *P. cinnabarinus* has been channeled to the production vanillin and vanillyl alcohol via reductive pathway. Cellobiose act as an energy source for the expression of reductive pathway and as an inducer of cellobiose:quinone oxidoreductase which inhibits vanillic acid decarboxylation in methoxyhydroquinone generation^{19,20,21}. Addition of cellobiose without Amberlite XAD4 failed to significantly ($p > 0.05$) improved vanillin yield. Thus, resin Amberlite XAD4 has been proven to play a crucial role in improving vanillin yield during fermentation. As the accumulated vanillin was toxic to fungi²², its removal by the adsorbent resin Amberlite XAD4 was necessary to accelerate the production of vanillin in fermentation.

Overall, in this study, about 0.15 g of vanillin was successfully produced from 1 kg of OPEFB. Even though the productivity of vanillin from OPEFBF was still low, the potential of this biotransformation technology in biovanillin production couldn't be denied. High accessibility of OPEFBF from the local oil palm industry has created great opportunity for the development of oil palm biorefinery in Malaysia^{23,24}. Further study on the optimization of biovanillin production from OPEFBF via fermentation is necessary.

4. Conclusion

Through this study, recovered lignin was found to be more effective than black liquor, as a substrate for biovanillin production via *Pycnoporus cinnabarinus* fermentation. Only 2.53±0.34 ppm of vanillin was produced by *P. cinnabarinus* in 5 days fermentation. However, the vanillin yield had multiplied by 2.6-fold to 6.50±0.75 ppm, when cellobiose and resin Amberlite XAD4 were added during the fermentation. Resin Amberlite XAD4 has been proven to play a significant role in improving vanillin production from OPEFBF lignin. Nevertheless, the yield of vanillin obtained in this study still not achieve at a satisfactory level. Therefore, further study on the optimization of this fermentation was suggested.

Acknowledgment

We acknowledge The National University of Malaysia (UKM) for the financial support under the research grant scheme with project code no DIP-2012-018.

References

- Goh CS, Tan KT, Lee KT, Bhatia S. Bio-ethanol from lignocellulose: Status, perspective and challenges in Malaysia. *Bioresour Technol* 2010; 101:4834-4841.
- The Economic Planning Unit. 1 Malaysia: Charting development towards a high income nation. In. *10th Malaysia Plan (2011-2015)*, Putrajaya: Prime minister's department, 2010; p. 125-127.
- Sufaiman F, Abdullah N, Gerhauser H, Shariff A. A perspective of oil palm and its wastes. *J Phys Sci* 2010; 21:67-77.
- Cardoso M, Oliveira ED, Passos ML. Chemical composition and physical properties of black liquors and their effects on liquor recovery operation in Brazilian pulp mills. *Fuel* 2009; 88: 756-763.
- Mohamad Ibrahim MN, Nor Nadiah MY, Norliyana MS, Shuib S. Separation and characterization of the vanillin compound from soda lignin. In: Senar B, editor. *Innovation in Chemical Biology*, Netherland: Springer Netherland; 2009, p. 103-110.
- Camera-Roda G, Augugliaro V, Cardillo A, Loddo V, Palmisano G, Palmisano L. A pervaporation photocatalytic reactor for the green synthesis of vanillin. *Chem Eng J* 2013; 224: 136-143.
- Gioia DD, Francesca L, Negroni A, Ficca AG. Metabolic engineering of *Pseudomonas fluorescens* for the production of vanillin from ferulic acid. *J Biotechnol* 2011; 156:309-316.
- Araujo JDP, Grande CA, Rodrigues AE. Vanillin production from lignin oxidation in a batch reactor. *Chem Eng Res Design* 2010; 88: 1024-1032.
- Kaur B, Chakraborty D. Biotechnological and molecular approaches for vanillin production: A review. *Appl Biochem Biotechnol* 2013; 169:1353-1372.
- Tang PL, Osman H, Jamaliah MJ, Wan-Aida WM, Mohamad-Yusof M. Fibrous agricultural biomass as a potential source for bioconversion to vanillic acid. *Int J Polym Sci* 2014; DOI: <http://dx.doi.org/10.1155/2014/509035>.
- Sun RC, Fang JM, Tomkinson J, Bolton J. Physicochemical and structural characterization of alkali soluble lignins from oil palm trunk and empty fruit bunch fibers. *J Agr Food Chem* 1999; 47:2930-2936.
- Oddou J, Stentelaire C, Lesage-Messen L, Asther M, Ceccaldi BC. Improvement of ferulic acid bioconversion into vanillin by use of high density cultures of *Pycnoporus cinnabarinus*. *Appl Microbiol Biotechnol* 1999; 53: 1-6.
- Stentelaire C, Lesage-Messen L, Oddou J, Bernard O, Bastin G, Ceccaldi BC, Asther M. Design of a fungal bioprocess for vanillin production from vanillic acid at scalable level by *Pycnoporus cinnabarinus*. *J Biosci Bioeng* 2000; 89: 223-230.
- Anonymous. *Amberlite XAD4 information sheet*. USA: Rohm and Haas Company, 2006.
- Chakar FS, Ragauskas AJ. Review of current and future softwood kraft lignin process chemistry. *Ind Crops Prod* 2004; 20:131-141.
- Buranov AU, Mazza G. Extraction and purification of ferulic acid from flax shives, wheat and corn bran by alkaline hydrolysis and pressurized solvents. *Food Chem* 2009; 115: 1542-1548.
- Billa E, Tollier MT, Monties B. Characterisation of the monomeric composition of *in situ* wheat straw lignin by alkaline nitrobenzene oxidation: Effect of temperature and reaction time. *J Sci Food Agr* 1996; 72:250-256.
- Converti A, Aliakbarian B, Dominguez JM, Vazquez GB, Perego P. Microbial production of biovanillin. *Brazilian J Microbio* 2010; 41:519-530.
- Thibault JF, Asther M, Ceccaldi BC, Couteau D, Delattre M, Duarte JC, Faulds C, Heldt-H HP, Kroon P, Lesage-Meessen L, Micard V, Renard CMGC, Tuohy M, Hulle SV, Williamson G. Fungal bioconversion of agricultural by-products to vanillin. *LWT-Food Sci Technol* 1998;31:530-536.
- Bonnin E, Grange H, Lesage-Meessen L, Asther M, Thibault JF. Enzymatic release of cellobiose from sugar beet pulp, and its use to favour vanillin production in *Pycnoporus cinnabarinus* from vanillic acid. *Carbohydr Polym* 2000; 41:143-151.
- Zheng L, Zheng P, Sun Z, Bai Y, Wang J, Guo X. Production of vanillin from waste residue of rice bran oil by *Aspergillus niger* and *Pycnoporus cinnabarinus*. *Bioresour Technol* 2007; 98:1115-1119.
- Lesage-Meessen L, Delattre M, Haon M, Thibault JF, Ceccaldi BC, Brunerie P, Asther M. A two-step bioconversion process for vanillin production from ferulic acid combining *Aspergillus niger* and *Pycnoporus cinnabarinus*. *J Biotechnol* 1996; 50: 107-113.
- Malaysia Palm Oil Board (MPOB). Production of crude palm oil 2013. Available online : <http://bepi.mpob.gov.my/index.php/statistics/production/118-production-2013/603-production-of-crude-oil-palm-2013>. html [24 September 2014]. Malaysia : Malaysia Palm Oil Board.
- Menon V, Rao M. Trends in bioconversion of lignocelluloses : Biofuels, platform chemicals & biorefinery concept. *Progr Energy Combust Sci* 2012; 38:522-550.



Institute of Tropical
Disease
Universitas Airlangga

in a collaboration
with



Institute for Protein Research
Osaka University

Proceeding

Molecular and Cellular Life Sciences:
Infectious Diseases, Biochemistry and
Structural Biology
MCLS 2015

ISBN 978-602-14292-4-2

A High Prevalence of Oral Manifestations and Its Profile among HIV/AIDS Patients at UPIPI Dr. Soetomo General Hospital Surabaya 2014

Bagus Soebadi^{a*}, Mintarsih Djamhari K^a, Adiastuti Endah P^a, Erwin Asta Triyono^b,
Remita Adya Prasetyo^c, Sulistyowati Budi^c, Alexander Patera Nugraha^d

^aOral Medicine, Faculty of Dentistry, Universitas Airlangga, Jl. Prof. Dr. Mayjend Moestopo No. 47 Surabaya, Indonesia

^bInternal Medicine, Faculty of Medicine, Universitas Airlangga, RSUD Dr. Soetomo, Jl. Prof. Dr. Mayjend Moestopo No. 47 Surabaya

^cOral Medicine, Installation of Dental and Oral Health, RSUD. Dr. Soetomo, Jl. Mayjen. Prof. Dr. Moestopo 6-8 Surabaya, Indonesia

^dUndergraduate Student, Faculty of Dentistry, Universitas Airlangga, Jl. Prof. Dr. Mayjend Moestopo No. 47 Surabaya, Indonesia
Kampus UNAIR, Surabaya 60286, Indonesia

Abstract

AIDS is one of the greatest public health threats for the human race. Regarding HIV/AIDS infection, oral manifestation can be used as a clinical biomarker to determine stage and progression, as well as to predict the onset of opportunistic diseases. Aiming to discern the profile of oral manifestations among HIV/AIDS patients at UPIPI (Infectious Disease Intermediate Care Unit) of Dr. Soetomo General Hospital, this study applies descriptive observational research with cross-sectional and total sampling method. Samples for this study were taken from medical records of 88 HIV/AIDS patients from July to August 2014. Subjects have the following characteristics: male - female ratio of 1.8:1, aged 26-35 (42.05%), married (75%), highschool educated (52.27), entrepreneur (35.22%), heterosexual oriented (95.45%), and HIV transmission through sexual intercourse (95.45%). Examination of the subjects' oral cavity results in 59.1% of the patients receiving antiretroviral therapy with 69.32% having <math><200\text{ CD4}^+</math> count, 120 cases of oral manifestation, 65 cases (54.17%) of Candidiasis Oral, 31 cases (25.83%) of Angular Cheilitis, 15 cases (12.5%) of Oral Hairy Leukoplakia, 7 cases (5.83%) of Linear Gingival Erythema, and 2 cases (1.67%) of Necrotizing Ulcerative Periodontitis. In conclusion, oral Candidiasis is the most common oral manifestation strongly associated with HIV/AIDS that is mostly transmitted through sexual intercourse by heterosexuals.

Keywords: Epidemiology; Oral Manifestation; HIV/AIDS

107

1. Introduction

Acquired Immune Deficiency Syndrome (AIDS) is a group of symptoms characterizing diseases caused by the decrease or damage of the immune system, whose etiology is the Human Immunodeficiency Virus (HIV)¹. The number of patients with HIV infection increases annually, infecting the entire world population and becoming a global health problem. HIV has been endangering human health for more than 20 years. By the end of 2012, there were about 35.3 millions of people living with HIV/AIDS worldwide². From 1987 to September 2014, as many as 150,296 people living with HIV and AIDS with a mortality rate equal to 55,799 for HIV and 9,796 for AIDS. In Indonesia, East Java Province is the second province with the highest HIV-infected amounting to 19,249 patients and 8,976 AIDS patients³. Dr. Soetomo General Hospital in Surabaya, East Java, is one of the type-A Hospitals which is in charge of handling the largest referral patients throughout eastern Indonesia, including referral handling and treatment of HIV/AIDS⁴. The hospital has a division for treating HIV/AIDS patients called the Infectious Disease Intermediate Care Unit (UPIPI). In 2014, the number of people suffering from HIV/AIDS admitted to UPIPI reached a total of nearly 1300 patients, including 50 new patients every month⁵.

Oral health plays an important role in assessing the systemic health of a person's overall health status, with no exception in HIV/AIDS case⁶. Oral manifestations often show early clinical signs of systemic diseases

* Corresponding author. Tel.: +62 81333016192 fax: -.
E-mail address: alexander.sandro11@gmail.com

including HIV/AIDS. Oral manifestations of HIV infection can be used to classify the stage of the disease, predict morbidity, and show overall health status of a patient⁷. In addition, oral manifestations may become clinically important biomarkers in HIV infection, such as Oral Candidiasis (OC), Angular Cheilitis (AC), Oral Hairy Leukoplakia (OHL), Linear Gingival Erythema (LGE), Necrotizing Ulcerative Gingivitis (NUG), Necrotizing Ulcerative Periodontitis (NUP), Kaposi's Sarcoma (SK), and Non-Hodgkin's Lymphoma (NHL)^{6,7}. Accordingly, research on the profile of oral manifestations associated with HIV/AIDS in some regions of the world is important to explain the epidemic of HIV/AIDS and can be used as reference for further researches.

This study was conducted to determine and reveal the profile of oral manifestations in HIV/AIDS patients at UPIPI Dr. Soetomo General Hospital Surabaya in 2014.

2. Methods

A descriptive observational study with cross-sectional and total sampling method is applied in this study. The samples consisted of 120 cases in 88 HIV/AIDS patients treated at UPIPI Dr. Soetomo General Hospital from July to August 2014 based on the set criteria. Patients agreed to participate were required to fill in informed consent. Diagnosis of the oral manifestation was based on clinical appearances, and the oral cavity was examined by dentists specializing in Oral Medicine. CD4⁺ counts and other data were obtained from the patients' medical records and personal interviews.

3. Results and discussion

Table 1. Total Sampling of HIV dan non-HIV Patients at UPIPI from July to Agust 2014

Sample	Total
HIV+	88 (100%)
HIV-	0

Table 2. Gender Distribution of HIV/AIDS Patients

Gender	HIV
Men	57 (64.77%)
Women	31 (35.23%)
Total	88 (100%)



Fig. 1. Prevalence of Oral Manifestation in HIV/AIDS Patients

Table 3. Prevalence of Oral Manifestations among HIV/AIDS Patients at Inpatient and Outpatient Wards of UPIPI

Oral Lesion	Inpatient	Outpatient	Total Cases
Oral Candidiasis	53 (44.17%)	12 (10%)	65 (54.17%)
Angular Cheilitis	31 (25.83%)	-	31 (25.83%)
Oral Hairy Leukoplakia	13 (10.83%)	2 (1.67%)	15 (12.5%)
Linear Gingival Erythema	6 (5%)	1 (0.83%)	7 (5.83%)
Necrotizing Ulcerative Periodontitis	2 (1.67%)	-	2 (1.67%)
Total	105 (87.5%)	15 (12.5%)	120 (100%)

Table 4. Distribution of HIV/AIDS Patients Based on Educational Background

Education	Total
Elementary	17 (19.32%)
Junior High school	16 (18.18%)
Senior High school	43 (48.86%)
Bachelor's degree	10 (11.36%)
Uneducated	2 (2.27%)
Total	88 (100%)

Table 5. Distribution of HIV/AIDS Patients Based on Occupation

Job	Total
Private Employee	24 (27.27%)
Entrepreneur	29 (32.95%)
Civil servants	4 (4.55%)
Labor	22 (25%)
Unemployee	9 (10.23%)
Total	88 (100%)

Table 6. Distribution of HIV/AIDS Transmission at UPIPI

HIV Transmission	Total
Sexual Intercourse	84 (95.45%)
Injected Drug User	4 (4.55%)
Total	88 (100%)

Table 7. Distribution of HIV/AIDS Patients at UPIPI Based on Sexual Orientation

Sexual Orientation	Total
Heterosexual	84 (95.45%)
Homosexual	4 (4.45%)
Total	31 (100%)

Table 8. Distribution of HIV/AIDS Patients at UPIPI Based on Marital Status

Marital Status	Total
Married	66 (75%)
single	22 (25%)
Total	88 (100%)

Table 9. Distribution of ARV user in HIV/AIDS Patients at UPIPI

ARV	Total
Yes	52 (59.1%)
No	36 (40.91%)
Total	88 (100%)

Table 10. The distribution of age, gender and CD4 + count value in patients with HIV

Age (year)	CD4 ⁺ < 200 sel/mm ³		CD4 ⁺ 200-500 sel/mm ³		CD4 ⁺ > 500 sel/mm ³		total
	Male	female	male	Female	male	female	
16-25	7	3	1	1	2	0	14 (15.91%)
26-35	15	8	5	4	3	2	37 (42.05%)
36-45	9	4	1	2	0	1	17 (19.32%)
46-55	6	3	1	1	1	0	12 (13.64%)
>55	4	2	1	0	0	1	8 (9.1%)
Total	41	20	10	7	6	4	88 (100%)
	61 (69.32%)		17 (19.32%)		10 (11.36%)		



Fig. 1. Oral Candidiasis

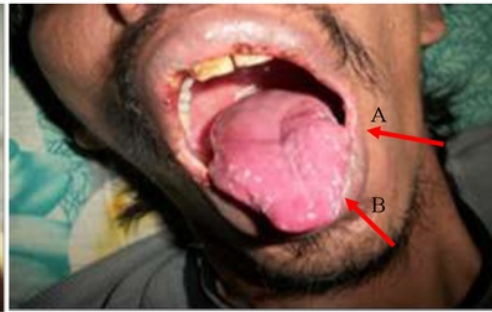

Fig. 2. Angular Cheilitis (A) and Oral Candidiasis (B)



Fig. 3. Oral Hairy Leukoplakia



Fig. 4. Necrotizing Ulcerative Periodontitis



Fig. 5. Linear Gingival Erythema

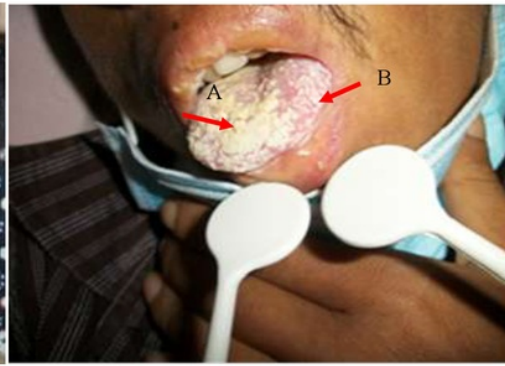

Fig. 6. Oral Candidiasis (A) and Oral Hairy Leukoplakia

558

Human Immunodeficiency Virus (HIV) is a retrovirus. Retroviruses are viruses that have the ability to use the host RNA and DNA to form DNA virus with an incubation period of about 5 to 10 years. HIV infects the body with a long incubation period (latent period), and is able to cause symptoms of a disease called Acquired Immunodeficiency Syndrome (AIDS)¹. HIV infection is a viral infection that lowers the immunity of the body significantly and progressively. HIV-specific has an affinity with CD4⁺ (helper T Cells). HIV attacks and disrupts homeostasis efforts made by the body so that the host is susceptible to opportunistic infections. People with HIV/AIDS sustain immunodeficiency syndrome that cause a variety of clinical manifestations including clinical manifestations that appear in the oral cavity⁸. Disorder of immunity system can lead to an unbalanced condition of ecosystem in the oral cavity. Normal flora in the oral cavity from commensal becomes pathogen that it can cause opportunistic infections in the oral cavity¹². Oral manifestations may indicate systemic conditions of person and an initial clinical signs that can predict the progression of HIV infection into AIDS⁹.

This study was conducted at the Infectious Disease Intermediate Care Unit (UPIPI) Dr Soetomo General Hospital with regards to the fact that the hospital is the second largest referral center in Indonesia, serving Eastern Indonesia. The hospital is owned by the Government of East Java province and has served in the health sector since 1938. It also has become one of the seven hospitals designated by the Ministry of Health as a Pilot Project of HIV/AIDS service since 2010⁵.

321

This study reveals (see Table 1) that there were 120 cases of oral manifestations in 88 HIV/AIDS positive patients. Table 2 shows that the number of people living with HIV/AIDS consisted of 57 male patients (64.77%) and 31 female patients (35.23%). Meanwhile, the subjects on a previous study by Hartanto¹⁰ at UPIPI Dr. Soetomo General Hospital in 2011 consisted of 69% male and 31% female patients. These differences occur due to differences in lifestyle, habits, and behavior between the sexes. As men are more likely to have multiple partners, they have higher risk for contracting HIV/AIDS, whereas female patients are usually victims who contracted HIV/AIDS from husbands who frequently change partners.

In Fig. 1, OC was commonly found in HIV/AIDS, with as many as 65 cases (54.17%) and followed by the AC with 31 cases (25.83%). Table 3 shows 65 cases of OC (54.17%), consisting of 53 OC cases in Inpatient (44.17%) and 12 cases of OC in Outpatient (10%). The number of OC cases encountered was more than that in Hartanto's study¹⁰ on Inpatient of Dr. Soetomo Hospital in 2011, which was 31 cases (66%). According to Suyoso¹¹, OC often arises in people with HIV/AIDS due to immunodeficiency which enables fungal colonies in the oral cavity turn from commensal into pathogenic. Thus far, OC in HIV/AIDS is believed as opportunistic infections as a result of decreased immune system and closely related with HIV/AIDS infection.

Table 1 shows that there were 31 cases found in the overall AC Inpatient (25.83%). The number of such cases was more than that of Hedge⁵ in India in 2012 with 16 cases (12.8%) and Davoodi¹² in Iran in 2014 with 17 cases (17%). The difference in results was attributed to differences in customs and behaviors in each community groups, including habits related to healthcare. According to Kartono et al¹³, AC occurs due to HIV/AIDS infection resulting in immunodeficiency so that bacteria such as *Staphylococcus aureus*, streptococci and commensal fungal *Candida* in the oral cavity become pathogenic. *Candida* has corresponding specific receptors on the cell wall of bacteria *Staphylococcus aureus* adhesin and agglutinin receptor-like Protein Sequence 3 (AIS3P) - one of the hyphaespecific genes.

In Table 3, there were 15 cases of OHL (17.04%) consisting of 13 cases of OHL in Inpatient (10.83%) and 2 cases of OHL in Outpatient (1.67%). The number of such cases was less than that that found in Davoodi¹² in Iran in 2014 with 17 cases (17%) and Hedge¹⁴ in India with 16 cases (12.8%). These differences depend on the levels of CD4⁺ in HIV/AIDS patients at the time of inspection. OHL reflects the condition of decreased level of CD4⁺ so that these lesions can be used as a clinical biomarker of CD4⁺ condition with HIV/AIDS¹⁰. OHL often arises in people with HIV/AIDS who have CD4⁺ count of 200-500 cells/mm³, especially in CD4⁺ cell <300/mm³. OHL appears in HIV/AIDS patients with a low immune system so that the EBV virus that was initially dormant

becomes pathogen¹².

The most common periodontal manifestation patients with HIV/AIDS was Linear Gingival Erythema as found in 7 cases (7.95%), consisting of 6 cases of LGE in Inpatient (5%) and 1 case of LGE in Outpatient (0.83%). Meanwhile, there were only 2 cases (1.67%) of Necrotizing Ulcerative Periodontitis (NUP) found in the Inpatient. The number of such cases was more than that found in Hartanto's¹⁰ study in 2011, in which there were only 5 cases (11%) of Inpatient UPIPI LGE and no case of NUP. Such difference may occur due to the use of a larger sample in this study. It also indicates a tendency of oral manifestations of differences arising from each time. According to Reznik & O'Daniels¹⁵, oral manifestations of periodontal lesions tend to rise not because of the condition of plaque or calculus but due to immunodeficiency that occurs in people with HIV/AIDS. NUG, NUP and LGE may arise when the number of CD4⁺ count is less than 200 cells/mm³. The decrease of immunity and inflammatory responses has resulted in disruptions that develop commensal microorganisms into pathogens that cause NUG and NUP. NUG occurs when there is necrosis of gingival tissue due to marginal gingivitis as *Bacteroides melaninogenicus* and commensal bacteria symbiosis, such as *Bacillus fusiform* and *Borellia vincentii*. NUG will continue to develop into NUP which eventually results in periodontal destruction. Clinically, it can be seen from the surface layer of the tooth root surface or cementum that can cause teeth mobility. According to Hedge⁵, LGE arises due to Candida infection in subgingival which triggers an inflammatory response in the free gingival margin so it will appear like a red line and sometimes involve attached gingiva. According to Aas¹⁶, microbiological examination of subgingival plaque on LGE in HIV/AIDS patients with a high viral load and low CD4⁺ levels detected *Saccharomyces cerevisiae* as the only species of fungi in LGE, whereas *C. albicans* was not detected. *C. albicans* were detected on LGE in patients with HIV/AIDS with a low viral load and high levels of CD4⁺. Nonetheless, Pathobiogenesis of LGE has not been fully explained yet.

Table 4 reveals that people with HIV/AIDS educated in senior high school comprised as many as 43 patients (48.86%). Accordingly, Spiritia¹⁷ also found 50.8% people with HIV/AIDS with senior high school education. Education is an important tool to gain knowledge, including knowledge regarding HIV/AIDS. It is generally assumed that the higher the level of education a person has, the more concern he or she has over his or her health. However, in fact there are many people living with HIV. Therefore, counseling and prevention of HIV/AIDS are required to raise awareness of HIV/AIDS.

Table 5 shows that most HIV/AIDS patients work as Entrepreneur with a total of 29 patients (32.95%), while the rest works as civil servant, employee, student, or labor. Occupation surely has an effect on lifestyle and behaviors as they relate to income. The higher the income will likely affect a person to lead a more modern lifestyle that includes free sex and drug use, which are risk factors for HIV/AIDS¹⁷.

Table 6 illustrates the prevalence of HIV/AIDS transmission among the patients, in which the majority or as many as 84 patients (95.45%) were infected through sexual intercourse, while the other 4 patients (4.55%) were infected through drug-way syringe (IDUs). These data are consistent with the data from KPAI¹⁸ in 2012 in which as many as 204 patients (53.40%) contracted through sexual intercourse, 161 patients (42.15%) due to injecting drug use, and 6 patients (1.57%) through perinatal, while for the remaining 11 patients the cause was unknown (2.88%). In terms of the mode of transmission, the proportion of HIV/AIDS through sexual intercourse (both heterosexual and homosexual) dominated, reaching up to 60%, and through the syringe by 30%, while the rest varied from perinatally infection, blood transfusions and through exposure at work. This finding reflects an iceberg phenomenon where the actual incidence may still be higher than the actual number reported.

In Table 7, based on the sexual orientation, the majority of people with HIV/AIDS were heterosexuals. Based on Spiritia¹⁷, in 2014 the highest percentage of AIDS risk factors are at risk of heterosexual sex (67%), MSM (Men Sex Man) (6%), the use of non-sterile needles to IDUs (6%), and from mother to child HIV positive (4%). Meanwhile, Table 8 shows that people with HIV/AIDS were mostly married; therefore, the transmission of HIV/AIDS occurred between married couple from husband to his wife or from wife to her husband through sexual intercourse with heterosexual orientation.

In Table 9, there were as many as 52 HIV/AIDS patients (59.1%) using ARV in order to suppress viral load and increase CD4⁺ counts. In this study, oral manifestation was most prevalent in the 26-35 year age group with as many as 37 patients (42.05%). Finally, Table 10 summarizes Bodhade's¹⁹ research in India on HIV/AIDS patients over the age of 30. Symptoms of HIV/AIDS infections usually appear within 7-10 years after HIV infection, hence it is estimated that the age of the patient at the time of infection is still fairly young at around 18-27 years old, a fairly productive age group as workers as well as reproduction. The large number of people living with HIV/AIDS in young age indicates that during this period of mental development to the maturation stage, people tend to become easily affected by environmental conditions and negative lifestyles, including sexual promiscuity and the use of narcotic drugs and syringes, which are high risk factors for contracting HIV/AIDS¹⁷. This further proves that in the productive age group, oral manifestation is mostly found in people with HIV/AIDS whose immune system is low. In people with HIV/AIDS, low immune system affects the function and the number of macrophages and neutrophils. Accordingly, phagocytosis process that can eliminate fungal infections, bacteria, viruses become obstructed.

4. Conclusion

Based on discussion above, the prevalence of oral manifestations in patients with HIV/AIDS at UPIPI Dr. Soetomo General Hospital in 2014 revealed Oral Candidiasis as the most common oral manifestation strongly associated with HIV/AIDS. In this study, HIV/AIDS was mostly transmitted through sexual intercourse infecting persons with heterosexual orientation. In conclusion, oral manifestation that is closely related to HIV/AIDS infection can be used as a promising clinical biomarker to determine stage and progression, as well as to predict the onset of opportunistic diseases.

256

Acknowledgements

The authors would like to thank the Universitas Airlangga (UNAIR) Faculty of Dentistry, RSUD Dr. Soetomo Surabaya and all paramedics of UPIPI RSUD Dr. Soetomo who participated in data collection.

References

1. Nasronudin. HIV&AIDS Pendekatan Biologi Molekuler: Klinis dan Sosial. Airlangga University Press. Surabaya. 2007; pp. 205-215.
2. Joint United Nations Programme on HIV/AIDS (UNAIDS). 2013 Global
3. Report on the Global AIDS epidemic. Journal of Epidemiology. 3: 5-6. From UNAIDS.org Last Update April 2014.
4. Kementerian Kesehatan RI. Direktorat Jenderal Pengendalian Penyakit dan Penyehatan Lingkungan. Pedoman Nasional Tatalaksana Klinis Infeksi HIV dan Terapi Antiretroviral pada Orang dewasa. Jakarta. 2014; 1-2
5. Unit Perawatan Intermediet Penyakit Infeksi (UPIPI). Laporan Triwulan I 2014 HIV/AIDS. RSUD Dr. Soetomo Surabaya. 2014; p.1.
6. Moylett EH. and Shearer W.T. HIV: Clinical manifestations. *J Allergy Immunol.* 2002; 110:3-16.
7. Coogan MM., Greenspan J., Challacombe S.J. Oral Lesion in Infection with Human Immunodeficiency Virus. *Bulletin of the World Organization.* 2005; 83:700-706.
8. Fanales-Belasio E., Raimondo M., Suligoi B., Butto S., HIV Virology and Pathogenetic Mechanism of Infection: A Brief Overview. *Ann Ist Super Sanita.* 2010; 46(1): pp. 5-14.
9. Vaseliu N., Kamiru H., Kabue M. Oral Manifestation of HIV Infection. HIV Curriculum for the Health Professional. *J Stomatology.* 2011; 7(6) 53-55. Available at hivdent.org Accessed on May 2th 2014.
10. Hartanto B., Hendarti HT., Soebadi B. Prevalensi Lesi Oral yang Terkait Erat dengan HIV pada Penderita HIV/AIDS di UPIPI RSUD Dr. Soetomo Surabaya. *Oral Medicine Dental Journal.* 2011; 3(1): p. 1.
11. Suyoso S. Kandidiasis Mukosa. Kelompok Studi Dermatomikosis Surabaya, FK Unair dan RSUD Dr. Soetomo -Surabaya. 2010; pp.20-25.
12. Davoodi P., Hamian M., Nourbaksh R., Motayamel FA. Oral Manifestations Related to CD4 Lymphocyte Count in HIV-Positive Patients. Dental Research, Dental Clinics, Dental Prospect. *Journal of Oral Med.* 2014; 7(1): 3-5. Available at dentistry.tbzmed.ac.id/joddd. Accessed on May 2th 2014.
13. Kartono AF., Soebadi B., Radithia D. Prevalensi Angular Cheilitis pada Waria Penderita HIV/AIDS di PERWAKOS. *Oral Medicine Dental Journal.* 2014; Vol. 6 No. 2:40-47
14. Hedge M.N., Hedge N.D., Malhotra A. Prevalence of Oral Lesion in HIV Infected Adult Population of Mangalore, Karnataka-India. *Reserch Article Issue.* 2012; 4: p.1.
15. Reznik DA. Perspective Oral Manifestation of HIV Disease. *Topics in HIV medicine.* 2005; 13(5): Pp.143-148.
16. Aas JA., Barbuto SM., Alpagot T., Olsen I., Dewhirst FE., Paster BJ. Subgingival Plaque Microbiota in HIV Positive Patients. *Journal of Clinical Periodontology.* Havard. 2007;34: Pp. 189-195.
17. Spiritia. Infeksi HIV/AIDS. *Jurnal Penyakit Dalam.* 2014; 3(3) 5-7. Available at spiritia.or.id/li/bacali.php?lino=508. Accessed on September 2014.
18. Komisi Penanggulangan AIDS Indonesia. Situasi HIV & AIDS di Indonesia. KPAI Press. Jakarta. 2010;p. 2.
19. Boddhade AS., Ganvir SM., Hazarey VK. Oral Manifestations of HIV Infection and Their Correlation with CD4 Count. *Journal of Oral Science.* 2011; Vol. 53, No. 2, 203-211, 2011 Nagpur, Maharashtra, India. Pp. 203-211



Institute of Tropical
Disease
Universitas Airlangga

in a collaboration
with



Institute for Protein Research
Osaka University

Proceeding

Molecular and Cellular Life Sciences:
Infectious Diseases, Biochemistry and
Structural Biology
MCLS 2015

ISBN 978-602-14292-4-2

The Isolation of Duck Ceca Bacteria as Probiotics to prevent Salmonellosis

Mohammad Anam Al-Arif^{a*}, Suwarno^b

^aAnimal Husbandry Department, Veterinary Medicine Faculty, Universitas Airlangga Campus C, Mulyorejo – Surabaya 60115

^bMicrobiology Department, Veterinary Medicine Faculty, Universitas Airlangga Campus C, Mulyorejo – Surabaya 60115

Abstract

This study aims to find out bacteria that can prevent *Salmonella* infection. Several healthy ducks were slaughtered and then approximately 1 g of ceca juice was taken from them. Each juice was diluted several times with sterile distilled water and grown in MRS media. It was then incubated 37°C for 48 hours. The morphology and inhibitory activity of the grown isolates against *Salmonella* bacteria were examined by superimposing isolates on the media that have been overgrown with *Salmonella* bacteria (1×10^7 CFU/ml). Four colonies of bacteria were obtained, all of which were Gram positive. One isolate was coccus form and three isolates were rod form. Three isolates showed inhibition against *Salmonella pullorum* with 15-17 mm diameter of clear zone, while one isolate against *Salmonella enteritidis* has 7-9 mm clear zone diameter. This suggests that the isolates obtained from duck ceca are more dominant in inhibiting the proliferation of *Salmonella pullorum* than of *Salmonella enteritidis*.

Keywords: bacteria isolation; duck ceca; probiotic; *Salmonella pullorum*; *S. enteritidis*.

1. Introduction

Livestock product is a source of nutrition for human life, but it can also endanger health if it is not safe. Therefore, food security is an absolute requirement to prevent zoonotic and food-borne disease¹. Food-borne disease is a human disease caused by food contaminated with pathogenic bacteria. Bacterial diseases that could potentially cause food-borne diseases are Salmonellosis, Shigellosis, Campilobacteriosis, Botulismus and *Eschericia coli* infection². Chicken is one of important sources of transmission of *Salmonella*. *Salmonella* can be transmitted to human, especially when people consume foods that are not well cooked or from infected animals³.

Probiotic in poultry serves as a growth promoter⁴. It also maintains the balance of beneficial microbes in the digestive tract, eliminates microbial pathogens including *Salmonella*⁵, increases the surface area of the intestine, as well as reduces the macroscopic and microscopic lesions caused by bacterial infection⁶. Alkhalf *et al*⁷ points out that the probiotic in broiler chickens can lead to the increased levels of antibodies to the ND virus significantly.

Microbes in the ceca can protect the poultry from bacterial infections and affect the function of the small intestine to improve the absorption of nutrients affecting the growth rate⁸. The inoculation of bacterial cultures from adult chicken ceca is proven to increase the growth rate of broiler chickens in the first 3 weeks and prevent *Salmonella* infection⁹. Therefore, the bacteria in the poultry ceca can be used as a source of probiotics. Ducks are known to be more resistant to infection of Avian Influenza virus than chickens¹⁰. This is likely due to bacteria in the duck ceca are able to stimulate immunity so that ducks infected with AI virus show no symptoms of illness.

This study aims to isolate bacteria from the duck ceca, which has the potential to inhibit the growth of *Salmonella* bacteria that can be used later as probiotics to protect broilers from *Salmonella* infection.

* Corresponding author. Tel.: 082131038615; fax: -
E-mail address: a_alarif@yahoo.com

2. Methods

The research materials are adult ducks purchased at the animal market in Surabaya, MRS media (Becton, Dickinson) and Bactoagar (Becton, Dickinson).

2.1 Isolation of probiotic bacteria

Ten healthy adult ducks were slaughtered. The ceca were taken aseptically afterward. The juice of each cecum was weighed 1 g and diluted with 10 ml of sterile distilled water. The dilution was repeated 10 times. Each of isolates was further grown in MRS medium (Man Rogosa Sharpe) and incubated at 37°C for 48 hours. The isolates were refined several times in the MRS medium to make them pure¹¹.

2.2 Inhibition test against pathogenic bacteria

The isolates were then grown in MRS broth and incubated at 37°C for 24 hours. Colonies that grew later were laid on sterile paper disks and were incubated for 5 minutes. Isolates were then superimposed on the media that had been overgrown with *Salmonella* bacteria (1×10^7 CFU ml⁻¹) and incubated at 37°C for 24 hours. Isolates which showed wide diameter of clear zone would be chosen as seed isolates.

3. Results and discussion

The culture of duck cecum juice on MRS medium (Man Rogosa Sharpe) shows that some of bacteria colonies grow. Pure bacteria culture is subsequently colored with Gram stain. In Gram stain, it is commonly known that these bacteria exist in the form of cocci, short rods and long rods. All isolates are Gram-positive as shown in Table 1.

Table 1. Macroscopic and Microscopic picture of Four Kinds of Cellulolytic Bacteria Colonies Isolates

Character	Isolat A-2	Isolat A-3	Isolat C-2	Isolat I-2
Macroscopic				
Color	White	White	White	White
Form	Round	Round	Round	Round
Edge	Smooth	Smooth	Smooth	Smooth
Elevation	Convex	Convex	Convex	Convex
Texture	Slimy	Slimy	Slimy	Slimy
Microscopic				
Gram	Positive	Positive	Positive	Positive
Form	Coccus	Short-Rod	Rod	Rod

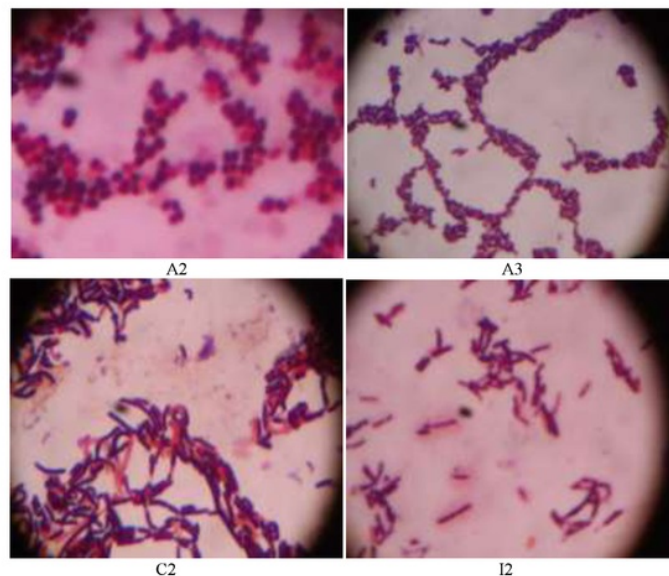

Fig. 1. Bacterial isolates in duck ceca on Gram staining.

Each paper disk that already contained isolates was taped over with *Salmonella* culture. After an incubation period was completed, isolates isolated in the paper disk successfully inhibited the proliferation of *Salmonella* bacteria by forming a clear zone as shown in Table 2.

Table 2. Inhibitory Activity of Duck Ceca Bacteria Against *Salmonella pullorum* and *Salmonella enteritidis*

Isolate	Clear Zone Diameter (mm) in <i>Salmonella pullorum</i> Culture	Clear Zone Diameter (mm) in <i>Salmonella enteritidis</i> Culture
A2	17	9
A3	17	9
C2	15	7
I2	5	5

Jozefiak *et al*¹² stated that cecum is a fermentative organ and the highest microbial populations in the gastrointestinal tract. However, it is also a place that allows the infection of pathogenic bacteria such as *Salmonella* sp. to take place. There are five isolates of bacteria found in the poultry ceca. They are *Lactobacillus*, *Bifidobacterium*, *Salmonella*, *Campilobacter* and *Eschericia coli*.

Fig. 2 shows that some isolates have inhibitory effect on *Salmonella pullorum* by forming a clear zone with the diameter of 15-17 mm. On the other hand, isolates which are against *Salmonella enteritidis* only form a clear zone with the diameter of 7-9 mm. This suggests that the isolates obtained from duck ceca are more dominant in inhibiting the proliferation of *S. pullorum* than of *S. enteritidis*.

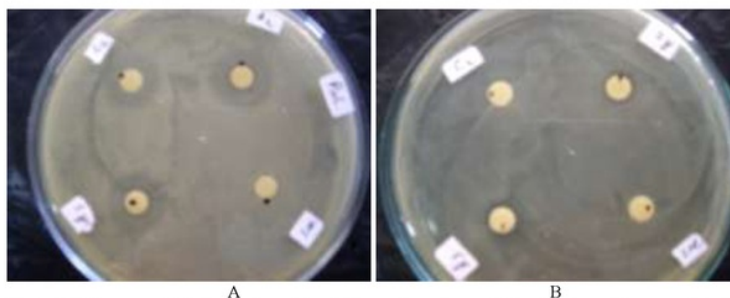

Fig. 2. Inhibitory test of duck ceca bacteria to *Salmonella pullorum* (A) and *Salmonella enteritidis* (B).

Surachon *et al*¹¹ found 56 isolates that have inhibitory effect on *S. enteritidis*, but only 13 isolates have a clear zone of 19 mm diameter. Three isolates can survive at pH 2.5 for 18 hours, and one of the isolates was identified as *Lactobacillus salivarius* TP 4.2-2.

Pullorum disease spreads widely and almost all countries in the world are already infected¹³. In some developing countries, the infection of *S. pullorum* is familiar and Pullorum disease is a threat to the poultry farm^{14,15}. Economic losses caused by Pullorum disease are decreasing, particularly for egg production, hatchability reduction, as well as morbidity and mortality which can reach 80-100%¹⁶.

S. pullorum persists in the reproductive tract of chicken, as the consequences could be spread vertically to the chicks via trans-ovarian transmission of bacteria into the hatching egg¹⁷. The horizontal spread can be transmitted through the water, feed, cage equipment, or through intermediaries such as insects or rodents¹⁸, as well as wild birds^{19,20}.

S. enteritidis is the causative agent of gastroenteritis in humans. Patients usually become infected by eating unwell-cooked poultry products²⁰. In chickens, *S. enteritidis* does not show significant symptoms disease, but it can infect multiple organs such as ovaries that can infect eggs. *S. enteritidis* in chickens is a series of important *Salmonella* infection. Some strategies are developed by the researchers to eradicate *Salmonella* from chicken farms, for example by biosecurity, vaccination, acidification of feed or drinking water, food modification, and the use of feed additives including probiotic, prebiotic and synbiotic²¹.⁵⁵¹

Lactic Acid Bacteria (LAB), particularly *Lactobacillus* sp., which play a role in the health and the digestive system in animals and humans, is an important probiotic among all probiotic bacteria. LAB have the ability to ferment, produce lactic acid and antimicrobial substances and colonization in the digestive tract of the hosts^{22,23,24}. In the poultry industry, LAB have commonly been used as probiotics to stimulate the growth of and control the pathogenic agent in the gut (eg. *Salmonella* sp.) for several decades²⁵.

It can be concluded that several bacterial isolates can be isolated in the duck ceca to potentially inhibit the proliferation of *S. pullorum* and *S. enteritidis*. It is shown that the isolates are more dominant in inhibiting the proliferation of *S. pullorum* than of *S. enteritidis*.

4. Conclusion

In this study we found that all *V. alginolyticus* strains isolated from the environment and diseased fish produced several extracellular enzymes and the results of AP-PCR patterns also demonstrated that these isolates are genetically heterogeneous. However, further research on protein expression of this species may clarify their role in bacterial pathogenesis.

Acknowledgements

Acknowledgements are submitted to the Directorate of Higher Education, which has funded this research through research projects of the Leading Universities (2011-2012). The author declares no conflict of interest with the parties involved in this study.

References

- Mensah P, Yeboah-Manu D, Owusu-Darko K, Ablordey A. Street foods in Accra, Ghana: how safe are they? *Bulletin of the World Health Organization*. 2002; 80: 546-553.
- Kaferstein FK. Food safety as a public health issue for developing countries. In: Food safety in food security and food trade. Unnevehr LJ (Ed). 2020 *Vision for Food, Agriculture, and the Environment Focus*. 2003; p5-6.
- Chittick P, Sulka A, Tauxe RV and Fry AM. A summary of national reports of foodborne outbreaks of Salmonella Heidelberg infection in the United States: clues for diseases prevention. *Journal of Food Protein*. 2006; 69: 1150-1153.
- Khaksefidi A, Ghoorchi T. Effect of probiotic on performance and immuno-competence in broiler chicks. *Journal of Poultry Science*. 2006; 43: 296-300.
- Mountzouris KC, Tsirtsikos P, Kalamara E, Nitsch S, Schatzmayr G, Fegeros K. Evaluation of the efficacy of probiotic containing *Lactobacillus*, *Bifido-bacterium*, *Enterococcus*, and *Pediococcus* strains in promoting broiler performance and modulating cecal microflora composition and metabolic activities. *Poultry Science*. 2007; 86: 309-317.
- Samanya M, Yamauchi K. Histological alterations of intestinal villi in chickens fed dried *Bacillus subtilis* var. *natto*. *Comparative Biochemistry and Physiology*. 2002; 133: 95-104.
- Alkhalif A, Alhaj M, Al-Homidan I. Influence of probiotic supplementation on immune response of broiler chicks. *Egypt. Poultry Science*. 2010; 30(1): 271-280.
- Kabir SML, Rahman MM, Rahman MB, Rahman MM, Ahmed SU. The dynamics of probiotics on growth performance and immune response in broilers. *International Journal of Poultry Science*. 2004; 3: 361-364.
- Nurmi E, Rantala M. New aspects of *Salmonella* infection in broiler production. *Nature*. 1973; 241: 210-211.
- Susanti R, Retno DS, Mahardika I GNK, Wibawan IWT, Suhartono MT. Identification of pathogenicity of avian influenza virus subtype H5N1 from waterfowls base on amino acid sequence of cleavage site hemagglutinin protein. *Indonesian Journal of Biotechnology*. 2008; 13(2): 1069-1077.
- Surachon P, Sukon P, Chaveerach P. Screening of lactic acid bacteria isolated from chicken ceca for in-vitro growth inhibition of *Salmonella enteritica* serovar enteritidis. *Journal of Animals and Veterinary Advances*. 2011; 10(8): 939-944.
- Józefiak D, Rutkowski A, Martin SA. Carbohydrate fermentation in the avian ceca: a review. *Animal Feed Science and Technology*. 2004; 113: 1-15.
- Charlton BR. Annual disease manual. 2nd Edition. The American Association of Avian Pathologist. Kennet square, Pennsylvania. 2000; p110-146.
- Majid A, Siddique M, Khan MZ. Prevalence of Salmonellosis in commercial chicken layers in and around Faisalabad. *Pakistan Veterinary Journal*. 1991; 11: 37-41.
- Nabbut N. The salmonella problem in Lebanon and its role in acute gastroenteritis. *Journal of Food Protection*. 1993; 56: 270-272.
- Shah DH, Lee MJ, Park JH, Eo SK, Kwon JT, Chae JS. Identification of *Salmonella gallinarum* virulence genes in a chicken infection model using PCR-based signature-tagged mutagenesis. *Microbiology*. 2005; 151: 3957 - 3968.
- Snoeyenbos GH. Pullorum disease. In: Calnek BW, Bames HJ, Beard CW, Reid WM and Yoder Jr HW. *Diseases of Poultry*. 9th ed. Ames: Iowa State University Press. 1991; p73-86.
- Dodson SV, Maurer JJ, Holt PS, Lee MD. Temporal changes in the populations genetics of *Salmonella pullorum*. *Avian Diseases*. 1999; 43(4): 685 - 695.
- Uhart MM, Quintana F, Karesh WB, Braselton WF. Hematology, plasma biochemistry and serosurvey for selected infectious agents in southern giant petrels from Patagonia. *Journal of Wild Diseases*. 2003; 39: 359 - 365.
- EFSA. Analysis of the baseline survey on the prevalence of *Salmonella* in holdings with breeding pigs in the EU, 2008 - Part A: *Salmonella* prevalence estimates. *European Food Safety Authority*. 2009; 7(12): 1377-1416.
- Vandeplas S, Dauphin RD, Beckers Y, Thonart P, Thévis A. *Salmonella* in chicken: current and developing strategies to reduce contamination at farm level. *Journal of Food Protein*. 2010; 73: 774-785.
- De Keersmaecker SCJ, Verhoeven TLA, Desair J, Marchalm K, Vanderleyden J, Nagy I. Strong antimicrobial activity of *Lactobacillus rhamnosus* GG against *Salmonella typhimurium* is due to accumulation of lactic acid. *FEMS Microbiology Letter*. 2006; 259: 89-96.
- Lima ET, Filho RLA, Okamoto AS, Noujaim JC, Barros MR, Crocci AJ. Evaluation in vitro of the antagonistic substances produced by *Lactobacillus* spp. isolated from chickens. *The Canadian Journal of Veterinary Research*. 2007; 71:103-107.
- Stern NJ, Svetoch EA, Eruslanov BV, Pereygin VV, Mitsevich EV, Mitsevich IP, Pokhilenko VD, Levchuk VP, Svetoch OE, Seal BS. Isolation of a *Lactobacillus salivarius* strain and purification of its bacteriocin, which is inhibitory to *Campylobacter jejuni* in the chicken gastrointestinal system. *Antimicrobial Agents and Chemotherapy*. 2006; 50(9): 3111-3116.
- Mead, GC. Prospects for "competitive exclusion" treatment to control salmonellas and other foodborne pathogens in poultry. *Veterinary Journal*. 2000; 159:111-123.



Institute of Tropical
Disease
Universitas Airlangga

in a collaboration
with



Institute for Protein Research
Osaka University

Proceeding

Molecular and Cellular Life Sciences:
Infectious Diseases, Biochemistry and
Structural Biology
MCLS 2015

ISBN 978-602-14292-4-2

Predominant Genotype of Hepatitis B Virus in HBsAg Positives Patients on Maintenance Hemodialysis, in Surabaya, Indonesia

Retno Handajani^{a,c*}, Pranawa^b, Mochammad Thaha^b, Mochamad Amin^c,
Takako Utsumi^d, Soetjipto^{a,c}

^aDepartment of Biochemistry, Faculty of Medicine, Universitas Airlangga, Surabaya, Indonesia

^bDepartment of Internal Medicine, Faculty of Medicine, Universitas Airlangga, Surabaya, Indonesia

^cInstitute of Tropical Disease, Universitas Airlangga, Surabaya 60115, Indonesia,

^dKobe University, Japan

Abstract

Genotype analysis of Hepatitis B Virus (HBV) in HBsAg positives patients on maintenance hemodialysis in Surabaya was performed. Twenty two HBV DNA were detected from 22 serum samples from hemodialysis patients with positive HbsAg. All 22 positive HBV DNAs were sequenced and phylogenetic tree was constructed using Genetyx10 version computer program. The predominant genotype of HBV from HBsAg positive patients on maintenance Hemodialysis in Surabaya Indonesia in this study belonged to genotype B.

Keywords: Hemodialysis; HBsAg positives; Hepatitis B Virus; Predominant Genotype.

1. Introduction

Hepatitis B virus (HBV) infection is a major health problem and a major cause of liver diseases in the world. Infection of HBV can be transmitted parenterally¹. Patients on maintenance hemodialysis are considered a high risk group to acquire hepatitis B virus (HBV) infection².

Based on complete or partial genomes, HBVs were classified into 10 genotypes, designated as A-J^{3,4,5}. Classification of the HBV genotype³ was based on >8% intergenotype and <4% intragenotype divergences nucleotides. In the previous studies, HBV genotype B, C and D were found in Indonesia⁶.

The aim of this study was to determine the predominant genotype of HBV in HBsAg positive patients on maintenance hemodialysis, in Surabaya, Indonesia.

2. Methods

Serum samples were obtained from 22 hemodialysis patients on maintenance hemodialysis in Dr. Soetomo Hospital Surabaya, Indonesia. All of the serum samples were Hepatitis B Surface Antigen (HBsAg) positive using AUSAB enzyme immunoassay (Diagnostic Division, Abbot Laboratories), which were then subjected to Polymerase Chain Reaction (PCR) using pairs of primers based on surface region of HBV genes. Alanine aminotransferase (ALT) serum levels were determined by using ALT (ALAT/ GPT) FS* (IFCC mod.) test kit (Diagnostic Systems International (Diasys), according to the manufacturer's instruction.

First-round PCR was conducted for over 35 cycles, each of which consisted of 1 minute at 94°C, 1 minute at 55°C, and 2 minutes at 72°C. The primers used to amplify a portion of the surface region of HBV were selected on the basis of the sequences reported to be conserved among many HBV isolates, P7 (sense) and P8

* Corresponding author. Tel.: -
E-mail address: retnoh@gmail.com

(antisense)⁷. The PCR products were electrophoresed in an agarose gel containing ethidium bromide and visualized by UV illumination. If there was negative result, second-round PCR was performed under the same condition, using the primers HBS1 (sense) and HBS2 (antisense)⁸. The PCR products were then electrophoresed as mentioned previously.

Direct sequencing of the DNA positive samples were performed using Sequencing kit (Perkin-Elmer) and ABI 310 sequencer DNA (Applied Biosystems, Inc.). Phylogenetic analysis of the HBV nucleotides obtained in this study and those available from international DNA data banks were compared by multiple sequence alignment. Phylogenetic tree was later constructed using Genetix 10 version computer program.

3. Results and discussion

Characteristics of the sampels are presented in Table 1. The genotype of HBV in this study belong to genotype B, presented in phylogenetic tree Fig 1.

Table 1. Characteristics of patients on maintenance hemodialysis

Patients	Male	Female	Total
No. of patients	16/22 (72.7%)	6/22 (17.3%)	22 (100%)
Mean Age \pm SD (years) (range)	48.53 \pm 11.59 (29 – 71)	47.5 \pm 6.09 (38-55)	46.05 \pm 10.18 (29 -71)
Mean SGPT \pm SD (IU/L) (range)	19.51 \pm 11.59 (16 - 53)	18.83 \pm 5.91 (11 – 22)	19.33 \pm 10.22 (11 – 53)
Mean HBsAg \pm SD (range)	1.68 \pm 1.10 (0.115 – 2.588)	1.68 \pm 1.17 (0.156 -2.425)	1.68 \pm 1.09 (0.115 – 2.588)

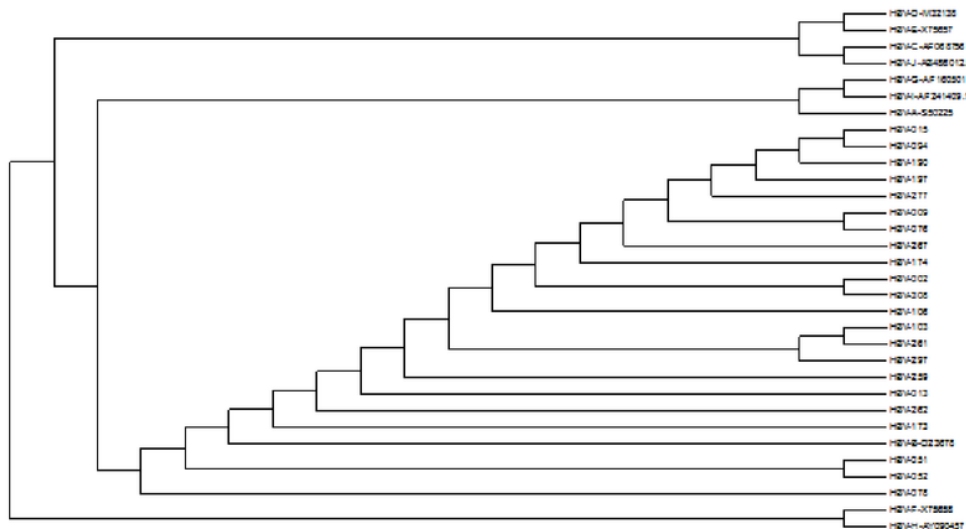

Fig 1. Phylogenetic tree nucleotides sequences of HBV isolates from patients on maintenance Hemodialysis populations in Surabaya, Indonesia, and reported sequences of 10 HBV genotypes A to J.

Serum samples with HBsAg positive were obtained from 22 hemodialysis patients, ranging from 29 to 71 years old with mean age of 46.05 years old, on maintenance hemodialysis in Dr. Soetomo Hospital Surabaya, Indonesia. The number of male patients in this study was greater than that of female. The mean age, ALT, and HBsAg levels were almost the same between male and female.

Twenty two HBV DNAs were detected from 22 sera obtained from hemodialysis patients with positive HBsAg. All 22 HBV DNA positive that have been sequenced and analysed were HBV B genotype. Even though there were HBV genotype B, C, and D found in Indonesia⁶, the predominant subtype of HBV in hemodialysis patients in this study was HBV genotype B. The multiple alignment figure of these nucleotides result showed

some consistent differences of nucleotide sequences from Indonesian samples compared to nucleotide of HBV B genotype Acc. No. D23878 from Japan (figure not shown). It is possible that nucleotides caused the different amino acids and serotype. Further analysis of the prediction of amino acid were required to know the serotype of those HBV.

HBV genotypes are widely distributed in different geographic area. The predominant HBV genotype in hemodialysis patients in Brazil⁹ and Khuzestan Iran² was HBV D genotype. The predominant HBV genotype in a group of patients may reflect the general predominant HBV genotype in that various geographical area.

4. Conclusion

HBV DNA were detected in all HbsAg positive serum samples and the predominant genotype of HBV was B genotype in hemodialysis patients' sera, in Surabaya, Indonesia.

References

1. Finkelston MA. Biology of Hepatitis B Virus Variants. *Lab. Invest.* 1994. 71. 3: 324 - 349.
2. Neisi N, Makvandi M, Samarbaf-Zadeh AR. A study on genotypes of hepatitis B virus among hemodialysis patients in Khuzestan province. *Jundishapur Journal of Microbiology (JJM)*. 2011. 4.2: 65-70.
3. Arauz-Ruiz PH, Norder BH, Robertson and Magnus LO. Genotype H: a new Amerindian genotype of hepatitis B virus revealed in Central America. *Journal of General Virology* 2002. 83:2059-2073.
4. Arankalle VA, Gandhe SS, Borkakoty BJ, Walimbe AM, Biswas D, Mahanta J. A Novel Recombinant (Genotype I) Similar to Vietnam/Laos in a Primitive Tribe in Eastern India. *J. Virol Hepatol* 2010. 10: 1365-2893.
5. Tatematsu K, Tanaka Y, Kurbanov F, Sughauci F, Mano S, Maeshiro T, Nakayoshi T, Wakuta M, Miyakawa Y, Mizokami, M. A Genetic variant of hepatitis B virus divergent from known human and genotypes isolated from a Japanese patients and provisionally assigned to new genotype. *J. Virol.* 2009. 83.20: 10538-10547.
6. Lusida MI, Nugrahaputra VE, Soetjipto, Handajani R, Fujii MN, Sasayama M, Utsumi T, and Hotta H. Novel Subgenotypes of Hepatitis B Virus Genotypes C and D in Papua, Indonesia. *J.C.M.*, July, 2008. 46:2160-2166.
7. Lindh, M., A. S. Anderson, and A. Gusdal. Genotypes, nt 1858 Variants, and Geographic Origin of Hepatitis B Virus Large-Scale Analysis Using a New Genotyping Method. *The Journal of Infectious Diseases.* 1997. 175: 1285-1293.
8. Telenta PFS, Poggio GP, Lopez JL, Gonzales J, Lemberg A, and Campos RH. 1997. Increased Prevalence of Genotype F Hepatitis B Virus Isolates in Buenos Aires, Argentina. *Journal of Clinical Microbiology*, July 1997. p.1873-1875.
9. Ferreira RC, Teles SA, Dias MA, Tavares VR, Silva SA, Gomes SA, Yoshida CFT, Martins RMB. Hepatitis B Virus Infection Profile In Hemodialysis Patients in Central Brazil: Prevalence, Risk Factors, and Genotypes. *Mem Inst Oswaldo Cruz*. Rio de Janeiro 2006. 101(6):689-692.



Institute of Tropical
Disease
Universitas Airlangga

in a collaboration
with



Institute for Protein Research
Osaka University

Proceeding

Molecular and Cellular Life Sciences:
Infectious Diseases, Biochemistry and
Structural Biology
MCLS 2015

ISBN 978-602-14292-4-2

266

The Prevalence of Anti-Hepatitis C Virus (anti-HCV) Antibody among Blood Donors in Tuban, East Java, Indonesia

Supiana Dian Nurtjahyani^{a*}, Mochamad Amin^b, Retno Handajani^{b,c}

^aDepartment of Biology Education, Faculty of Teaching and Education Science, Ronggolawe PGRI University Tuban, Indonesia.

^bInstitute of Tropical Disease, Universitas Airlangga, Surabaya 60115, Indonesia

^cDepartment of Biochemistry, Faculty of Medicine, Universitas Airlangga, Surabaya 60131, Indonesia.

Abstract

401

A study was conducted to determine the prevalence of Anti-Hepatitis C Virus (anti-HCV) Antibody among blood donors in Tuban, East Java, Indonesia. By using an EIA test Kit, anti-HCV antibodies were from 500 blood donors in Tuban, consisting of 375 males (75%) and 125 females (25%). Blood donors younger than 20 years old were formed the largest age group. Anti-HCV Antibodies were detected in 7 (1.4%) blood donors, all men. The result in this study showed a lower prevalence than the previous study in Indonesia.

Keywords: Hepatitis C Virus; Anti-HVC; Blood Donor; Tuban Indonesia.

1. Introduction

376

Hepatitis C Virus (HCV) infection is still a global public health problem. According to the WHO, about 3% or 170 million people, worldwide are infected with hepatitis C. The cases of new Hepatitis C virus infections every year¹. Infection of HCV transmitted parenterally, so it can be spread through blood transfusion and it also has been known that Hepatitis C virus (HCV) is a major etiologic agent of post transfusion as well as sporadic non-A, non-B hepatitis worldwide². It has been known that HCV is a major causative agent of chronic liver disease such as chronic hepatitis and liver cirrhosis, which often leads to hepatocellular carcinoma. The majority of individuals who acquire HCV infection are asymptomatic. Hepatitis C is a silent killer that may produce no symptoms for a long time and often the first sign of illness occurs when a person's liver stops working or they develop liver cancer³. Anti-HCV antibody is a common serological marker for detection of HCV infection. The prevalence of anti-HCV antibodies has been reported to vary in different blood donor centers in different areas of the same or different country^{4,5,6}. The aim of this study was to determine the prevalence of anti-HCV antibody in Tuban Red Cross Blood Donor Center, East Java, Indonesia.

2. Method

375

This research laboratory experiment is a cross-sectional study. In total, 500 serum samples were collected from blood donors in Tuban Red Cross Blood Donor Center, East Java, Indonesia, from January 2015 until March 2015. Blood samples were collected in a tube without anti coagulant and allowed to clot, then all samples were transported to the Institute of Tropical Disease, Universitas Airlangga, where the serum sample separation was carried out. Anti-HCV antibodies were detected using a EIA test kit.

3. Result and discussion

The age range of blood donors in this study from the Tuban district were between under 20 years and 70

*Corresponding author. Tel.: +620356322233; fax: +620356331578.

E-mail address: dianbn@yahoo.co.id

years, with an average age of 30.66 years. The youngest was 17 years and the oldest was 69 years old. The majority, 375 (75%) were men and the largest male age group was 21-30 years (20.6%). The largest group of women blood donors was under 20 years (10.4%). The ages and sex distribution of Tuban Blood Donors are presented in Table 1.

Table 1. Ages and Sex Distribution of Tuban Blood Donors

Sex	Age (Years)						Total (%)
	≤20 (%)	21-30 (%)	31-40 (%)	41-50 (%)	51-60 (%)	61-70 (%)	
Male	100/500 (20.0%)	103/500 (20.6%)	78/500 (15.6%)	72/500 (14.4%)	14/500 (2.8%)	8/500 (1.6%)	375/500 (75%)
Mean	17.77	26.95	34.32	45.13	53.5	64.5	31.32
SD	0.89	2.84	3.00	2.90	2.50	2.62	11.88
Female	52/500 (10.4%)	25/500 (5.0%)	20/500 (4.0%)	20/500 (4.0%)	8/500 (1.6%)	-	125/500 (25%)
Mean	17.71	25.44	34.65	45.25	53.88	-	28.77
SD	1.08	3.38	3.17	2.75	3.09	-	12.24
Total	152/500 (30.4%)	128/500 (25.6%)	98/500 (19.6%)	92/500 (18.4%)	22/500 (4.4%)	8/500 (1.6%)	500 (100%)
Mean	17.75	26.66	34.39	45.15	53.64	64.5	30.66
SD	0.95	3.00	3.02	2.86	2.67	2.62	12.01

In total, 7 (1.4%) of the 500 blood donors were detected as positive for anti-HVC sera and all were men. The results show that the prevalence of HCV is higher in males than females.

Table 2. The Result of Anti-HVC Antibody Detection in Blood Donors

Sex	Anti HVC	
	Positive (%)	Negative (%)
Male	7/500(1.4%)	368/500 (73.6%)
Female	0/500 (0%)	125/500 (25.0%)
Total	7/500(1.4%)	493/500 (98.6%)

Individual blood donors need to be in a healthy condition, because transfused blood from donors must be free of infectious diseases. All 500 serum samples were obtained from 375 male (75%) and 125 female (25%) blood donors in Tuban, East Java, Indonesia, with the mean \pm standard deviation of age 30.66 \pm 12.01 years. The age range of blood donors in Tuban Red Cross Blood Donor Center varied from under 20 years to 69 years. As people over 60 do not fulfill the criteria for blood donors, 8 (1.6%) blood donors were not allowed to continue as blood donors. The number of younger people (under 20 years old) donating blood was quite high in Tuban (30.4%) with an average of age 17.75 \pm 0.95. In this study, the age of blood donors tended to be younger (30.4% under 20 years old), especially women blood donors. The largest age group (10.4%) for women blood donors was the youngest group age (younger to 20 years old) with the mean \pm standard deviation of age 17.71 \pm 1.08 years. The largest age group (20.6%) for male blood donors was 21-30 years with the mean \pm standard deviation of age 26.95 \pm 2.84 years (Table 1). This result is in line with Makroo⁷ results in North India, in which younger blood donors (18-30 years) were more numerous than older groups.

Hepatitis C virus (HCV) is a blood-borne virus that causes chronic hepatitis, cirrhosis, and hepatocellular carcinoma. The most common routes of transmission of HCV in developed countries include intravenous drug use, blood transfusions, haemodialysis, needle-stick injuries, tattooing, sexual intercourse and peri-natal infections³. Infection of HCV is transmitted parenterally, therefore it can be spread through blood transfusion. In this study, anti-HCV antibodies were positive in 7 sera (1.4%) and all were from male blood donors. This prevalence of a positive anti-HCV antibody in blood donors in Tuban is lower than the prevalence of an anti-HCV antibody (2.3%) in 2234 blood donors in a previous study in Surabaya, Indonesia³. Inoue (2000), in a study conducted in Indonesia, showed that 161 out of the 7572 (2.1%) blood specimens were positive for antibodies of HCV⁵. Blood specimens in the Inoue study were collected from 21 of the 27 provinces in Indonesia during a survey of a total of 24 blood banks from November 1992 to February 1993. The prevalence rates of anti-HCV antibodies differ from place to place in Indonesia. The prevalence rates reported from some African countries also differ from place to place⁸. In previous studies, prevalence of 1.44% of 4650 positive anti-HCV blood donors in Cameroon was reported⁶. 6% of 200 blood donors in Nigeria⁸ and 1.57% of 15898 blood donors in New Delhi, India⁹. A study from West Pakistan reported that of 1.131 volunteer blood donors studied, 46 (4.1%) were positive for anti-HCV antibodies¹⁰ and in North India, 795 (0.39%) out of 206.022 blood donors were positive for the anti-HCV antibody⁷.

Prevalence rates of positive anti-HCV in developed countries are different to those in developing countries. In developed countries, prevalence rates of positive anti-HCV are low and in developing countries, the prevalence rates of positive anti-HCV are higher. This condition involves different socio-cultural practices

involving the use of sharp instruments contaminated by blood and body fluids for procedures such as scarifications, tattooing, circumcision and so on, which are common practices in many developing countries³. On the other hand, most developed countries now have low prevalence rates of positive anti-HCV because blood and blood products for transfusion are routinely tested for various blood-borne pathogens including HCV and measures such as the use of sterilized instruments and needle exchange programs for intravenous drug users have also served to reduce the prevalence of HCV infection³.

In the current study, the age range of blood donors with positive anti-HCV in Tuban Red Cross Blood Donor Center was 29-47 years, and all were men. Makroo (2013) showed that the highest positive anti-HCV prevalence was in the age group 18 to 30 years (0.41%) with the lowest in the age group 51-60 years (0.26%), and showed a decreasing trend with age⁷. Egah (2004) in Nigeria showed that 95% of blood donors were males with the age between 21 and 50 years and 6% positive-anti HCV were also all male⁸. Results regarding the gender of donors are in line with Sajed (2014), reporting from Lahore, Pakistan, who showed that the positive anti-HCV prevalence in men was higher than in women³. Jain (2003) reported the age distribution of anti-HCV reactivity showed a maximum prevalence rate of 1.8% in the age group of 20-29 years⁹. In addition, there is a clear declining trend for positive anti-HCV with an increase in age. Khattak (2008) reported that the age of blood donors in Pakistan infected with HCV tended to be higher in ages more than 27 years if they had a history of injections or intra venous drip in the past¹⁰. Mean while according to Jain⁹ and Gao¹¹, there was no significant difference between men and women in HCV infection.

Based on research in Semarang, Indonesia, from 5800 samples with Transfusion Transmitted Disease obtained from blood donors at the Semarang Red Cross from January 2008 to December 2012, HCV reactive was the third highest cause of infection (821 out of 5800), or 14.1%. The other causes were HBsAg reactive: 3198 (54.94%); Syphilis reactive: 1138 (19.5%) and HIV reactive: 673 (11.5%), as the 1st, 2nd, and 4th causes of infection respectively¹².

It is surmised that the lower Anti-HCV antibody detected in this study was caused by better health management and prevention of infection.

4. Conclusion

The prevalence of positive anti-HCV antibody in blood donors in Tuban, East Java, Indonesia is 1.4%.

Acknowledgement

The authors are grateful to Red Cross Blood Donor Center in Tuban, East Java, Indonesia, for providing blood samples, to the entire biology laboratory staff of Ronggolawe University, Tuban and ITD, Universitas Airlangga Surabaya for helping to do this research and Kopertis VII, Pendisikan, and The Ministry of Culture for the supporting research grant.

References

1. Sosro MAU, Wati DR, Astuti R. Insidensi penyakit menular lewat tranfusi darah di Unit Donor Darah PMI Semarang. *Med Hosp* 2014; Vol 2(2): 88-91.
2. Houghton MA, Weiner, Han J, Kuo G, and Choo QL. Molecular biology of the hepatitis C viruses: implications for diagnosis, development and control of viral disease. *Hepatology*. 1991;14:381-388.
3. Sajed AM, S Iram, S Haidar, A Sarwar, I Ahmad, S Imran, Q Naiz, H Akbar, UF Durrani, MA Imran and M Akbar. Prevalence of HCV in apparently healthy voluntary blood donors. *IOSR-JDMS e-ISSN: 2279-0853, p-ISSN: 2279-086*. 2014; Volume 13, Issue 6 Ver. 1 (Jun), PP 01-04 www.iosrjournals.org.
4. Soetjipto, Handajani R, Lusida MI, Darmadi S, Adi P, Soemarto, Ishido S, H Katayama Y, and Hotta. Differential prevalence of hepatitis C virus subtypes in healthy blood donors, patients on maintenance hemodialysis, and patients with hepatocellular carcinoma in Surabaya. *Indonesia.J. Clin.Microbiol.* 1996;34: 12, p.2875-2880.
5. Inoue Y, HA Sulaiman, Matsubayashi K, Julitasari, Linuma K, Ansari KA, Laras K and A. L. Corwin. Genotypic analysis of Hepatitis C virus in blood donors in Indonesia. *Am. J.Trop. Med. Hyg.* 2000;62(1), pp. 92-98.
6. Ymele FF, Keugoung B, Fouedjio JH, Kouam N, Mendibi S, and J. Mabou JD. High Rates of Hepatitis B and C and HIV Infections among Blood Donors in Cameroon: A Proposed Blood Screening Algorithm for Blood Donors in Resource-Limited Settings. 2012; <http://dx.doi.org/10.1155/2012/458372>.
7. Makroo R.N., Walia RS, Chowdhry M, Bhatia S, Hegde V& Rosamma NL. Seroprevalence of anti-HCV antibodies among blood donors of north India. *Indian J Med Res.* 2013;138, July, pp 125-128.
8. Egah DZ, Mandong BM, Iya D, Gomwalk NE, Audu ES, Banwat EBand Onile BA. Hepatitis C virus antibodies among blood donors in Jos Nigeria. *Annals of African Medicine*. 2004;Vol. 3, No. 1: 35 - 37.
9. Jain A, Rana SS, Chakravarty P, Gupta RK, Murthy NS, Nath MC, Gunraj S, Chaturvedi N, Verma U, Kar P. The prevalence of hepatitis C virus antibodies among the voluntary blood donors of New Delhi, India. *India. Eur J Epidemiol.* 2003;18 (7): 695-7.
10. Khattak MN, Akhtar S, Mahmud S danRoshan TM. Factors Affecting the Hepatitis C Virus Blood Donor Sero-prevalence in North West Pakistan. *Journal of Public Health Policy*. 2008;29, 207-225. Doi: 10.1057/jphp.2008.7.
11. Gao X, Cui Q, Shi X, Su J, Peng Z, Chen X, Lei N, Ding K, Wang L, Yu N, and Wang N. Prevalence and trend of hepatitis C virus infection among blood donors in Chinese mainland: a systematic review and meta-analysis. *BMC Infectious Diseases*. 2011;11:88.



Institute of Tropical
Disease
Universitas Airlangga

in a collaboration
with



Institute for Protein Research
Osaka University

Proceeding

Molecular and Cellular Life Sciences:
Infectious Diseases, Biochemistry and
Structural Biology
MCLS 2015

ISBN 978-602-14292-4-2

Analyze Activation Marker of Azurophilic Granule (CD63) and CFSE CD11c Expressions of Salivary Neutrophils Insevere Early Childhood Caries

Muhammad Luthfi^{a*}, Retno Indrawati^a, Ira Arundina^a, Yoes Prijatna Dachlan^b

^aDepartment of Oral Biology, Faculty of Dentistry, Universitas Airlangga, Surabaya-Indonesia

^bDepartment of Parasitology, Faculty of Medicine, Universitas Airlangga, Surabaya-Indonesia

Abstract

Early childhood caries is a very serious health problem because it is a chronic infectious disease that is infectious. In recent years the view has changed dramatically neutrophils, where neutrophils which are a key component of the first line of defense against pathogen through the process of phagocytosis. Neutrophils also release their granule contents such as defensins, Defensins (α defensins) are stored in the azurophilic granules have microbicidal function shown in enable macrophages to release tumor necrosis factor (TNF) and interferon γ (IFN γ) which promote pro inflammatory. α Defensin also increases the permeability of the epithelial monolayer in vitro and chemotactic effects on T cells, mast cells and dendritic cells. Purpose this research is to analyze activation marker of azurophilic granules and CFSE CD11c expression of salivary neutrophils in severe early childhood caries (S-ECC). Two groups ie, results mouthwash NaCl 1.5% samples of 20 early childhood caries-free and 20 severe early childhood caries. Salivary neutrophils that collected from severe early childhood caries analyzed using flow cytometry to detect the CD63 and CFSE CD11c expressions. Based on the average value is known that salivary neutrophils expressing CD63⁺ in early childhood caries-free higher ($2.67\% \pm 0.46$) in comparison to the severe early childhood caries ($2.32\% \pm 0.57$), likewise salivary neutrophils expressing CFSECD11c⁺ in early childhood caries-free higher ($2.44\% \pm 0.52$) in comparison to the severe early childhood caries (1.57 ± 0.39). Decreased activation marker azurophilic granules (CD63) and phagocytosis markers (CFSE CD11c) expressions may be one cause in the S-ECC.

Keywords: severe early childhood caries; neutrophils; azurophilic granules; phagocytosis.

1. Introduction

Early childhood caries is a very serious health problem. In 2003 the American Academy of Pediatric Dentistry (AAPD) has declared severity of the disease because it is a chronic infectious disease that menular¹. Dental caries begins after deciduous teeth grow and develop on the surface of the tooth with a very fast and progressive with manifestations of pain, acute and chronic abscesses, fever, swelling of the lips so that the appetite decreased².

Severe early childhood caries with decay exfoliation filling of teeth (def-t) > 6 is a form of very destructive because it involves several teeth, including maxillary anterior teeth³, with the signs is the smooth surface decay on children under three years of age and usually begins as soon as the first tooth eruption and growing rapidly to cavitation stage performance only 6 to 12 months⁴.

Early childhood caries prevalence is still very high, the results showed that the prevalence reached 80% in developing countries with a percentage five times more than asthma, seven times more than allergies, and fourteen times more than chronic bronchitis^{2,5}.

In Indonesia, Fitriani research results in 2007 in Semarang, show that at 90.5% in urban and 95.9% rural early childhood suffered from dental caries, while in Surabaya in 2006, the results of research conducted Indawati showed that 74% early childhood suffered from dental caries⁶.

108

* Corresponding author. Tel.: -

E-mail address: m.luthfi7@yahoo.com

Dental caries is a chronic disease, is multi factorial which began with the shift of microbiology in the complex biofilm (dental plaque) were affected by the consumption of sugar, salivary flow, and behavior^{7,8}. The shift toward bacterial plaque flora acidogenic and aciduric in a long time so that the pH of the plaque to be low which is accompanied with many foods containing sucrose and the factors involving oral hygiene, the aging, genetic factors, and changes in the immune system, making conditions the plaque that support the increasing number of species acidogenic and acid uric like *Streptococcus mutans* (*S. mutans*) or laktobasilus⁹.

Untreated dental caries can cause more severe effects on the body, including mortality¹⁰. The poor nutritional intake associated with pain in early childhood can reduce proper diet so that the immune system weakens and becomes more susceptible to infection. Various prevention of dental caries has been done, for example by brush their teeth, fluoridation by topical application and manufacture of vaccines to date have not shown the expected results¹¹.

In recent years the view has changed dramatically neutrophils, where neutrophils which are a key component of first line of defense against mikroba¹². Neutrophil not only act as the killing of microbes by phagocytosis, release of reactive oxygen species (ROS) and its antimicrobial peptide but also regulate activation of neutrophils immune responses¹³, besides neutrophils has resulted in a variety of cytokines, chemokines and growth factors that become a major contributor in the production pro inflammatory cytokines in the area of infection¹⁴.

Important function of neutrophils in killing pathogenic microbes is phagocytosis, which was significantly more effective due process of opsonization by antibody and complement contained in the surface of microbes. Phagocytosis against microbes can causes oxidative burst process of producing reactive oxygen species are accompanied by degranulation of cytoplasmic granules in the phagosome containing microbes that contains antimicrobial peptides and protease¹⁵.

During phagocytosis, there was internalization of microbes into the phagosome in neutrophils. Receptors involved in the recognition of microbes also activate neutrophils to kill microbes are ingested. A combination of the phagosome with neutrophil granules (lysosomes) leads to the formation of phagolysosome and at this point most of the microbicidal activity¹⁶.

Neutrophil contains three types of primary granules, granules azurophilic (primary granules) contain antimicrobial proteins such as defensins (HNP 1-3), elastase, cathepsin and proteinase-3 and contains CD63 highly potent in killing microbes both Gram positive and Gram negative, including *S. mutans* which is one of the predominant microbial cause of dental caries.

Based on the above, this study aims to identify risk factors for caries of the aspects of the immune system to identify neutrophil function as innate immunity effect or cells in preventing dental caries in early childhood.

2. Methods

Samples were obtained from kindergarten children in Surabaya region. Examination of dental caries was conducted by measuring its index of def-t, and after it has been examined subjects were divided into two groups: caries-free group and the S-ECC group with def-t more than 6. All subjects at the time of sampling old between 4 to 6 years. Prior to sampling in a sample, the distribution of questionnaire and signed a written informed consent by parents respectively.

Samples of saliva were taken to the isolation of *S. mutans* and from the mouth wash NCL 1.5% for the determination of phagocytic function analyzed by CFSE expression of CD11c and CD63 expression is a marker granulation azurophilic granules on the surface of neutrophils saliva. Sampling was done by researchers and trained person elusing a standard protocol. Subjects should not eat, drink, chew gum, or brushing teeth for 60 minutes before sampling. Having collected the samples was frozen at -80°C for analysis¹⁷.

2.1. *Streptococcus mutans* isolation from saliva

Isolation of *S. mutans* conducted from saliva samples taken from both preschool children identified as severe caries and caries-free conducted in the following way: isolation and biochemical characterization of *S. mutans* saliva samples were diluted in Brain Heart Broth (BHI), after incubation 24 hours.

Samples were grown on Triptone Yeast Cysteine (TYC) agar medium. Suspected colonies of *S. mutans* maked subculture to conducted biochemical tests using fermented mannitol, raffinose, sorbitol, salicin, esculin and arginine. Isolates were identified as *S. mutans* if positive for sugar fermentation and negative for arginine and subsequently confirmed by Gram staining and catalase test. Isolates of *S. mutans* is stored on -80°C¹⁷.

2.2. Isolation and Counting Total Salivary Neutrophils

Neutrophils in saliva obtained by subjects instructed to rinse with 10 mL of sterile 1.5% NaCl solution as he gargled his mouth but not swallowed for 30 seconds, then expectorated in sterile glass. This procedure was repeated 4 times. The next sample is centrifuged at a speed of 450 g for 15 minutes, at a temperature of 4°C. The results of further centrifugation pellets are mixed with 2 ml of RPMI medium then the sample in vortex then

filtered sequentially with 20 and 11µm nylon filter¹⁹. The results of the filter in the form of a suspension of cells is then counted using a hemocytometer.

2.3. Preparation of the *Streptococcus mutans* (*S. mutans*)

S. mutans isolated subsequent cultured in media Brain Heart Infusion (BHI) so that the tube for 48 hours in an aerobic jar. *S. mutans* culture results subsequent taken 1 ose and cultured back on BHI liquid medium for 48 hours in an incubator. *S. mutans* bacteria cultures are then put into the microtube and centrifuged at 12,000 rpm for 10 minutes at a 4°C. Pellets were then washed with PBS and centrifuged again with the speed, time, and temperature are the same. Pellets were then stained with 50 µl solution CFSE: PBS in the ratio 1:20. Bacteria that have dyed subsequent incubated in a 37°C temperature for 30-60 minutes in the dark (microtube coated aluminum foil). After incubation, the bacteria then centrifuged at a speed of 12,000 rpm, for 10 minutes, at a temperature of 4°C. Pellets were then washed with PBS 2 times by means of centrifugation back at the same speed. *S. mutans* bacteria were then killed by heating 60°C for 30-60 minutes. The bacteria were then washed with PBS and measured at 620 nm (0.35). Bacteria opsonised subsequent use as much 500 µl serum FCS and incubated at 37°C for 30 minutes. The next steps are conducted centrifugation with the same speed as before. Pellets containing bacteria, calculated using the haemocytometer to be taken and planted in the method of phagocytosis.

2.4. Phagocytosis activity Salivary Neutrophils against *S. mutans*

The principle underlying the process of phagocytosis caused by bacteria can be labeled with fluorescein isothiocyanate (FITC) and then bacteria difagosit by neutrophils, after it was given a second dye in the form of ethidium bromide (EB) which serves to bind DNA. EB is what will give color to the *S. mutans* is not in phagocytosis because the microbes that have internalized protected by a membrane of phagocytes that is not exposed to the dye. At Flowcytometer light scattering can be used to isolate a population of neutrophils. The combination of fluorescence and dissemination will identify *S. mutans* that has been labeled, neutrophils, and neutrophil containing *S. mutans* is ingested.

Neutrophils that have been isolated and regulated concentration calculated to be 2×10^6 /ml. Make sure that the cells are predominantly neutrophils (>95%) and the life (>95%) after the test with trypan blue propidium iodide by flow cytometer, thus cells are now ready to test phagocytosis.

In the phagocytosis test, the addition of 5 ml suspension as much as 2×10^6 neutrophils/ml of bacteria to the tube. Then 1 ml was transferred into a tube containing 1 ml of ice cold, 0.9% and 0.02% EDTA saline as a control. The same procedure was repeated every 15 minutes with new aliquot. This will give the results of phagocytosis over a period of 1 hour.

The engulfed of bacteria is determined by measuring green fluorescence at 525 nm in flow cytometry, using 488 nm excitation. To estimate the extra cellular fluorescence, immediately after running each tube add 1 ml of 3 mg/ml trypan blue, and then mixed and measured fluorescence signal again.

2.5. Measurement of CD63 Expression On Salivary Neutrophils

Profile measurement of neutrophil cells using CD63 antibody which is a marker of neutrophil activation. CD63 is the primary granule membranes were expressed on the membrane surface of neutrophils and increased due to the stimulation of the neutrophil cells (Faurischou and Borregaard, 2003) with the signs that can be measured by flow cytometry with the method that has been modified Bjornsson¹¹. The sample used is a sample result of 1.5% NaCl mouth wash that has been isolated neutrophils its. Neutrophil cell suspension that was isolated and then inserted into the microtube that has been filled as much 500 µl PBS. The cell suspension was then centrifuged at a speed of 2500 rpm, for 5 minutes at a temperature of 4°C. Pellets obtained were then stained with antibody extracellular much 50 µl (Biologend antihuman-α-CD63PE), and α-PI Biologend PE conjugated antibody ratio : PBS is 1: 200.

Cells that have been added antibody is then stored at 4°C for 30 minutes. Then the cell suspension added 1 ml PBS and centrifuged at 2500 rpm, for 5 minutes at 4°C. Pellets then added Biologend Cytfix Cytoperm as 100 µl and homogenized until well blended. Do incubation in the dark and 4°C for 20 minutes. After incubation, cells were then added 1 mL Biologend Washperm 1X and then centrifuged at a speed of 2500 rpm, for 5 min at 4°C. Pellets were then added intracellular antibodies, including BD antihuman α-CD64 PerCP conjugated, subsequent incorporated the cell suspension into flow cytometer cuvette, added as much as 300 µl PBS, and mounted on then ozzle to conducted BDFACS Calibur flow cytometer using the machine running. Samples were analyzed by flowcytometry (FACS Calibur flow cytometer, BD BioSciences, SanJose, CA).

Neutrophil gate identified by using density and size with aside angle light scatter and then forwarded to the forward angle light scatter. This compensation is achieved by using FITC and PE antibodies dilebel with the individual. The results are expressed as mean fluorescence intensity (MFI). FACS Calibur from Becton

Dickinson Cell Quests of ware program used for the analysis.

3. Results and discussion

3.1. CFSECD11C expression In Salivary Neutrophils at S-ECC and Free Caries

The test results of two independent samples T test showed that there was a significant decrease in the expression of CFSECD11c in salivary neutrophils S-ECC shown in Table1.

Table 1. The mean and standard deviation salivary neutrophils activated conduct phagocytosis of *S. mutans* were labelled by CFSE dye express CD11c⁺ in S-ECC and caries-free (%)

Group	n	Mean± standard deviation	standard deviation SD	P Value
Free Caries	20	2.44% ± 0.5	0.52732	0.000 (p<α)
S-ECC	20	1.57 ± 0.39	0.39038	

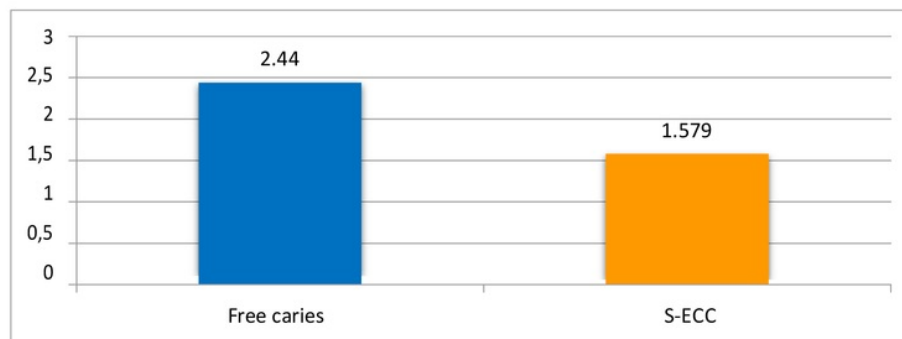

Fig.1. Phagocytosis of bacteria *S. mutans* were labeled by CFSE dye express CD11c⁺ in S-ECC and free caries (%).

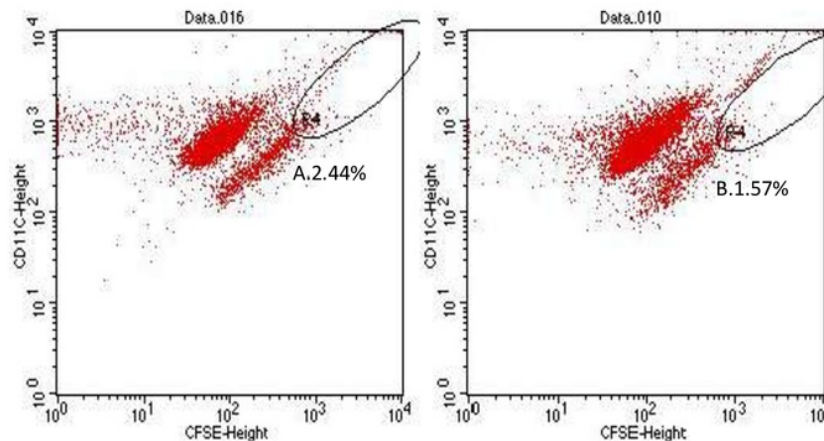

Fig.2. Activated salivary neutrophils conduct phagocytosis against *S. mutans* which in CFSE label edexpressing CD11c⁺ were detected using flow cytometry on early childhood caries-free (A) and S-ECC (B)

3.2. CD64⁺CD63⁺ Expression On Salivary Neutrophilsin S-ECC and Free Caries

Results of the analysis of activated salivary neutrophils (CD64⁺) that expresses CD63⁺ in early Childhood free caries and S-ECC are shown in Table 2.

Table 2. The mean and standard deviation of activated salivary neutrophils (CD64⁺) that expresses CD63⁺ in early Childhood free caries and S-ECC (%)

Group	N	Mean± Standard deviation	95%CI	p Value
Free Caries	20	2.67 ± 0.46	2.37-2.96	0.040 (p<α)
S-ECC	20	2.32 ± 0.57	1.96-2.68	

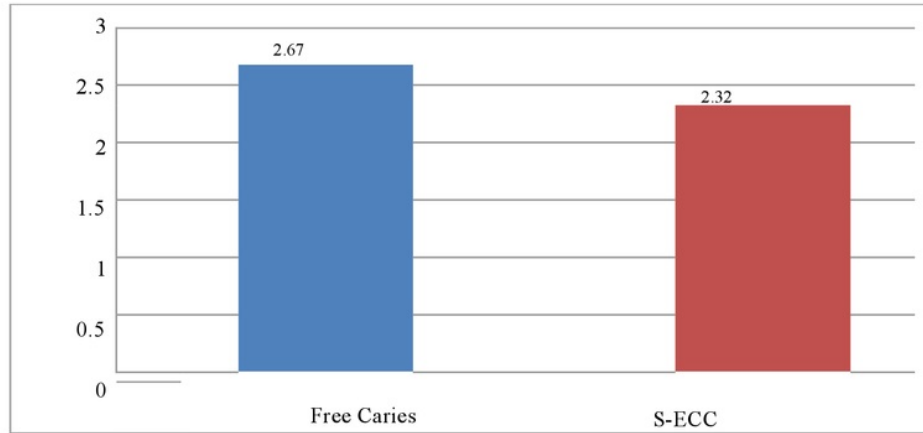

Fig.3. The mean and standard deviation saliva activated neutrophils (CD64⁺) that expresses CD63⁺ in early childhood caries-free and S-ECC (%)

The results of flow cytometry analysis using saliva activated neutrophils (CD64⁺) that expresses CD63⁺ which has been done using a different test independent 2 sample-test showed significant value which is smaller than α , this means that there are significant differences in the expression of CD63⁺ between the two groups. Based on the average value of salivary neutrophils it was known that expressing CD63⁺ in early childhood caries-free higher (2.67% ± 0.46) compared in S-ECC (2.32% ± 0.57).

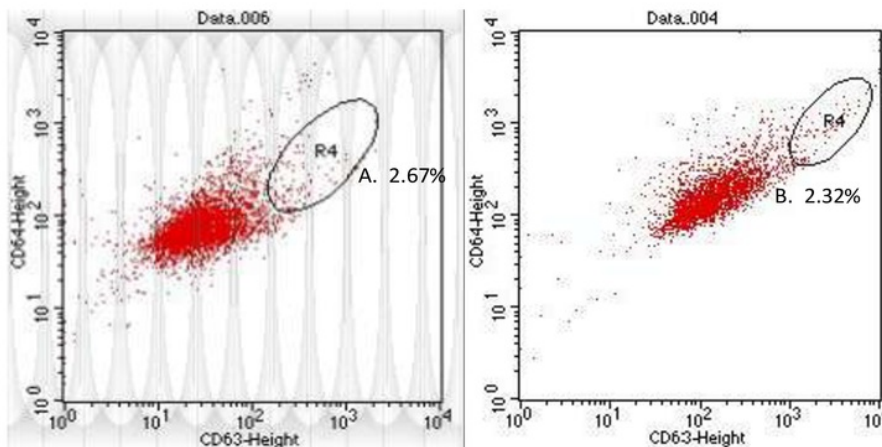

Fig.4. Salivary Neutrophil activated (CD64⁺) expressing CD63⁺ were detected using flow cytometry in early childhood free caries (A) and in S-ECC (B)

Streptococcus mutans plays an integral role etiology of dental caries in preschool children is an infectious disease transmitted¹⁸, so that *S. mutans* is considered an important predictor as cariogenic bacteria because it is acidogenic (able to produce acid) and acid uric (able to survive in an acidic environment)³.

In salivary neutrophil first line of defense is the most prominent of immune cells for defense against pathogens microbial. The importance of neutrophils in the host immune system in patients with neutropenia or defects in neutrophil function which leads to a tendency for the occurrence of serious infections¹⁹.

14
Neutrophil recruitment process, transmigration, phagocytosis, and activation of highly coordinated to prevent or eliminate infection in humans. In the area of infection, neutrophils bind and engulf microbes through a process known as phagocytosis. Neutrophils recognize the surface-bound or free molecules secreted bacteria, including peptidoglycan, lipoprotein, lipoteichoic acid (LTA), lipopolysaccharide (LPS), CpG-containing DNA, and flagellin. These pathogen molecules known as PAMPs, interact directly with a number of Pathogen Recognition Receptors (PRRs) expressed on the surface of cells, including Toll Like Receptors (TLRs)²⁰.

Dental caries severity varies greatly between individuals, and this variability may be due to differences in the microflora as well as differences in the immune system in response to oral microflora in general, the immune system in the oral cavity to prevent the invasion of the microflora²¹.

Neutrophils are important effect or cells in the first line of defense against pathogenic bacteria through the process fagocytosis²², the disruption phagocytic function against cariogenic bacteria may play an important role in the initiation and progress ion of dental caries. This, our study shows that the percentage of neutrophil phagocytosis against *S. mutans* which is the bacteria that cause dental caries showed significant declines in the S-ECC than in early childhood caries-free.

The ability of the pathogen to avoid internalizing and killings played a central role in the virulence strategies. Pathogens that have been internalized through a process of phagocytosis by neutrophils to developing three strategic defense system to avoid killing intracellularly is the first escape from the phagosome, the second blocking phagosome fusion-lisosome, and the third is the use of a mechanism to allow for the survival of the phagolysosomes²². Some species of bacteria including Streptococcus and Staphylococcus have evolved mechanisms to avoid opsonophagocytosis or action of the system complemen²³. The failure of the existing defense systems in saliva in early childhood in killing the *S. mutans* bacteria due to the possibility that there are strains of *S. mutans* in the oral cavity S-ECC has successfully developed a mechanism to fight the hydrolytic activity of lysozyme. This is supported by studies that say that some Streptococcus have an effective strategy to reduce the bactericidal effect of lysozyme.

Phagocytosis is active receptor-mediated process, in which cells internalize microbial later there cytoskeletal rearrangements, neutrophil plasma membrane extends around the target, initiate a process that ultimately creates a membrane-bound vacuoles called the phagosome. Neutrophil release granule mediators that are released upon degranulation orexocytosis of membrane-bound secretory granules. Neutrophils also have the capacity to release a variety of antimicrobial proteins and intracellular enzymes into membrane-bound organelle called the phagosome containing microbes.

Primary granules (azurophilic) contains many antimicrobial compounds such as myeloperoxidase (MPO), defensin in the form of human neutrophil peptides1-3 (HNP1-3), lysozyme, azurocidin, and serine proteinase elastase, cathepsin G, proteinase 3, esterase N, and so on. These granules associated with phagocytic vesicles release their contents in the phagosome causing microbes that have in phagocytosis²⁴.

The low expression of CD63 neutrophil saliva in severe early childhood caries may be due to *S. mutans* that has been internalized by phagocytosis of neutrophils through a process that is mediated through FcαR (CD89) or CR1 (CD35) might be able to develop three strategic defense system to avoid killing intracellular namely that the first escape phagosome, the second blocking phagosome fusion-lisosome, and the third is the use of a mechanism to allow for the survival of the phagolysosomes²².

Phagocytosis by neutrophils causes translocation of granulesto the phagosome which is a marker for the release of the granules contents. Caused by the release of granule contents as the mediator of granulocytes whicha re strictly controlled by a mechanism leading to exocytosis which took place in several phase²⁵, namely the recruitment of granule exocytosis from the cytoplasm to the membrane targets depend on rearrangement of actin and microtubulecy to skeleton followed by vesiclete the ring and docking, which leads to contact the outer surface of the lipid bilayer membrane around the granules with the inner surface of the target membrane²⁶.

The role of neutrophils as innate immunity lies in the lysosomal compartment shown in congenital abnormalities which cause the secretion of lysosomal events and lysosomal proteolysis disrupted as happens in Chediak-Higashi²⁹ Syndrome. And Lefevre Papillon-syndrome²⁸. The function of lysosome-associated membrane protein-2(-2LAMP) contained in neutrophil function is critical to the self-cleaning of the oral cavity that regulates natural defense against biofilm formation in the oral cavity. Phagosome fusion-lisosome is very important for the degradation of the internalized pathogens efficiently with lysosomes thus play an important role in the killing of bacteria that do not depend on oxygen²⁹. Neutrophil-deficient LAMP-2 caused deficiency of distribution and azurophilic granule fusion, cellular localization lactoferrin contained in the secondary granules which showed a reduction inco-localization of causing disruption of biogenesis, traffic, both types of granulesis a function that contributes to killings *S. mutans*³⁰ and it is a possibility that lysosome-associated membrane protein-2(LAMP-2) to contribute to fusion with neutrophil granules in phagosomes. Based on the low expression of CD63S-ECC possibility of deficiency LAMP-2 as found in mice that were suffering from periodontitis therefore LAMP-2 deficiency.

4. Conclusion

Decreased activation marker azurophilic granules (CD63) and phagocytosis markers (CFSE CD11c) expressions may be one cause in S-ECC.

2

References

1. American Academy of Pediatric Dentistry, Organizing Council. Definition of Early Childhood Caries (ECC) : *Pediatr Dent.* 2003. 25 :9.
2. Filstrup S.L, Briskie D, Fonseca M, Lawrence L, Wandera A, Inglehart MR, ECC and Quality of Life : Child and Parent perspectives. *Pediatr Dent.* 2003. 25:431-440.
3. Tinanoff N, Reisine S. Update on early childhood caries since the Surgeon General's Report. *Academic Pediatr.* 2009. 9 (6):396-403.
4. Weinstein J, et al. A novel mammalian protein, p55CDC, present in dividing cells is associated with protein kinase activity and has homology to the *Saccharomyces cerevisiae* cell division cycle proteins Cdc20 and Cdc4. *Mol Cell Biol.* 1994. 14 (5):3350-63.
5. Habibian M, Beighton D, Stevenson R, Lawson M, Robert G. Relation Between Dietary Behaviours, Oral Hygiene and Mutans streptococci Dental Plaque of a Group of Infants in Southern England. *Archives of Oral Biology.* 2002. 47:497-498.
6. Fitriani. Faktor Resiko Karies Gigi Sulung Anak (Study Kasus Anak TK Pangeran Diponegoro Semarang). Undergraduate Thesis, Diponegoro University. 2007.
7. Hicks J, Godoy FG, Flaitz C. Biological Factors in dental caries:role of saliva and dental plaque in dynamic process of demineralization and remineralization. *J Pediatric den.* 2003. 1:47-56.
8. Indrawati R. Aktivitas enzim dextranase dan sebaran genotype *Streptococcus mutans* penderita karies dan bebas karies. Program Pascasarjana Universitas Airlangga Surabaya. 2006.
9. Filoche, S.,Wong, L.& Sissons, C.H. Oralbiofilms:emerging concepts in microbial ecology. *Journal of dental research.* 2010. vol. 89, no.1, pp.8-18.
10. Otto, M. For want of a dentist. *The Washington Post.* 2007. p.B01.
11. Trigg,T.E.,etal. Use of a GnRH analogue implant to produce reversible Longterm suppression of reproductive function in maleand female domestic dogs. *J Reprod Fertil Suppl.* 2001. 57:p.255-61.
12. Elbim C, Katsikis PD, Estaquier J. Neutrophil apoptosis during viral infections. *Open Virol J.* 2009. 3:52-9.
13. Nathan, Neutrophils and immunity: challenges and opportunities. *Nat. Review. Immunol.* 2006. 3:173-82
14. Mantovani, A., M.A.Cassatella, C.Costantini, S.Jaillon. Neutrophils in the activation and regulation of innate and adaptive immunity. *Nat Rev Immunol.* 2011. 11:519-531.
15. Kobayashi SD, Voyich JM, Burlak C, DeLeo FR. Neutrophils in the innate immune response. *Arch Immunol Ther Exp.* 2005. 53:505-517.
16. Abbas AK, Lichtman AH, Pillai S. Cellular and Molecular Immunology. 6th edition. Saunders Elsevier. 2007.
17. Phattaratatip, E. The role of salivary antimicrobial peptides in shaping *Streptococcus mutans* ecology. dissertation, University of Iowa disease pathogenesis. *Annu Rev Microbiol.* 2010. 57:677-701.
18. Pejterskov, O. Changing paradigms in concepts on dental caries: consequences for oral health care. *Caries Res.* 2004. 38,182-91.
19. Rosenzweig S.D. and Holland S.M. Phagocyte immunodeficiencies and their infections. *J.Allergy Clin.Immunol.* 2004. 113,620-626.
20. Akira S. and Takeda K. Toll-like receptor signalling. *Nat Rev. Immunol.* 2004. 4,499-511.
21. Jewett A, Hume WR, LeH, Huynh TN, Han YW, Cheng G, et al. Induction of apoptotic cell death in peripheral blood mononuclear and polymorphonuclear cells by an oral bacterium, *Fusobacterium nucleatum*. *Infect Immun.* 2000. 68:1893-8.
22. Rosenberger CM and Finlay BB. Phagocyte sabotage: disruption of macrophage signalling by bacterial pathogens. *Nat Rev Mol Cell Biol.* May. 2003. 4(5):385-96.
23. Serruto D., Rino Rappuoli, Maria Scarselli, Piet Gros and Jos A. G. van Strijp. Molecular Mechanism Evasion. 2010. 8.p.393.
24. Skubitz KM. Neutrophilic leukocytes .In: Greer JP (eds) *Wintrobe's Clinical Hematology.* (the 12nd) Lippincott Williams and Wilkins, Philadelphia. 2009. 208
25. Toonen RF, Verhage M. Vesicle trafficking: pleasure and pain from SM genes. *Trends Cell Biol.* 2003. 13:177-86.
26. Burgoyne RD, Morgan A. Secretory granule exocytosis. *Physiol Rev.* 2003. 83:581-632.
27. Delcourt-Debruyne, E.M., H.R. Boutigny, and H.F. Hildebrand. Features of severe periodontal disease in a teenager with Chediak-Higashi syndrome. *J. Periodontol.* 2000. 71: 816-824.
28. Pham, C.T., J.L. Ivanovich, S.Z. Raptis, B. Zehnbauser, and T.J. Ley. Papillon-Lefevre syndrome: correlating the molecular, cellular, and clinical consequences of cathepsin C/dipeptidylpeptidase I deficiency in humans. *J. Immunol.* 2004. 173:7277-7281.
29. Smalley, J.W. Pathogenic mechanisms in periodontal disease. *Adv. Dent Res.* 1994. 8: 320-328.
30. Borregaard, N., and J.B. Cowland. Granules of the human neutrophilic polymorphonuclear leukocyte. *Blood.* 1997. 89:3503-3521.



Institute of Tropical
Disease
Universitas Airlangga

in a collaboration
with



Institute for Protein Research
Osaka University

Proceeding

Molecular and Cellular Life Sciences:
Infectious Diseases, Biochemistry and
Structural Biology
MCLS 2015

ISBN 978-602-14292-4-2

Insilico Docking Analysis Of *Imperata cylindrica* Pure Compound and Human Thymidylate Synthetase Mutant as Choriocarcinoma Anti Cancer Candidate

Reza Arta Bagaskoro Nugroho^{a*}, Ferry Ferdiansyah^b, Aulya Farra Rahmadany^b, St Khaerunnisa^a

^aPost graduated programme, Department of Medical Biochemistry, Faculty of Medicine, Universitas Airlangga, Surabaya

^bMedical Doctor Intership Programme, Ungaran Public Hospital, Semarang

Abstract

Choriocarcinoma is a malignant, belongs to gestational trophoblastic disease. Floxuridine chemo-resistance has been investigated in the role of thymidylate synthase transcript levels. *Imperata cylindrica* pure compound was thymidylate synthetase inhibitory potential agent. This study is exploring protein interactions between *imperata cylindrica* pure compound and human thymidylate synthetase mutant variant. *In silico* docking studies were carried out using AutoDock 4.2. The results showed that flavonol-selected human thymidylate synthetase mutant binding energy (-5.61 to -4.91) when compared with standard (-4.01 to -3.82) and inhibition constant (77.59 μ M to 250.28 μ M) compared with standard (1.02 mM to 4.15 mM). *Imperata cylindrica* pure compound docking result has more efficient than Floxuridine.

Keywords: Insilico; *Imperata cylindrica*; Human thymidylate synthetase; Anti-cancer

1. Introduction

Gestational trophoblastic disease is a tumours with a wide range of biologic behaviour. Gestational trophoblastic disease refers to both the benign and malignant entities of the spectrum, include hydatidiform mole, invasive mole, choriocarcinoma, and placental trophoblastic tumour. The last three are termed gestational trophoblastic tumours, potentially fatal if untreated^{1,2}. Choriocarcinoma is highly malignant tumor of trophoblastic cells. It is considered to be pertinent to molar pregnancy, normal or ectopic pregnancy and abortion¹. Choriocarcinoma composed of two types of cells, syncytiotropho-blasts and cytotrophoblasts. The syncytiotrophoblast is the differentiated hormone secreting component³. Choriocarcinoma, is even less common, affecting around 2 to 7 of every 100,000 pregnancies in the United States. Choriocarcinoma and other forms of gestational trophoblastic tumours are more common in many Asian and African countries. Overall, gestational trophoblastic tumors account for less than 1% of female reproductive system cancers⁴.

Several studies have demonstrated that cancer cells have a unique metabolism⁵. Metabolic changes in cancer cells are considered to be fundamental for the transformation of normal cells into cancer cells and are also responsible for the resistance to different types of chemotherapeutic drugs⁶. Among the different metabolic and signalling pathways that are altered in cancer cells, variations in the expression and activity of several drug metabolizing enzymes play a critical role in drug resistance⁷.

TS inhibitors are a new class of compounds that target TS, an enzyme in the folate metabolic pathways, necessary for thymidylate synthesis. By inhibiting TS, these agents decrease de novo thymidylate synthesis, which is necessary for DNA synthesis and repair. Contrary to prior empiric approaches to anticancer drug discovery, the development of new TS inhibitors was based on the targeted and specific design of new molecules and relied on extensive knowledge of the structure, conformation, and properties of TS and the mode of action

108

* Corresponding author. Tel.: +62 8125206366,
E-mail address: rzbagaskoro@gmail.com

of folate analogues⁸.

Flavonoids are a group of more than 4000 polyphenolic compounds that occur naturally in foods of plant origin. These compounds possess a common phenylbenzopyrone structure (C6-C3-C6), and they are categorized according to the saturation level and opening of the central pyran ring, mainly into flavones, flavanols, isoflavones, flavonols, flavanones, and flavanonols⁶. These polyphenolic compounds display a remarkable spectrum of biological activities including those that might be able to influence processes that are dysregulated during cancer development. These include, for example, anti-allergic, anti-inflammatory, antioxidant, antimutagenic, anticarcinogenic, and modulation of enzymatic activities⁷.

They may therefore have beneficial health effects and can be considered possible chemopreventive or therapeutic agents against cancer. This review article will focus on the anticancer activity of flavonoids as well as their molecular mechanisms, since they are among the most promising anticancer agents.

2. Materials and Methodology

The purpose of current study is exploring protein interactions between *Imperata cylindrica* pure compound and human thymidylate synthetase mutant variant to exploit a potentially synergistic interaction to enhance anticancer efficacy. Out of all the entries for Human Thymidylate Synthase Complex (1JU6) were taken from RCSB protein data bank. The active site residues were found to be Arg50, Leu192, Cys195, His196, Gln214, Arg215, Ser216, Asp218, Asn226, His256, Tyr258. The selected mutant group used in our experiment were single mutant (E23G, V84A, D110E, H250L), double mutant (T53S-Y258F), triple mutant (A17T, D11G, D254E) selected from the article *The Journal of Biological Chemistry* Vol. 277, No. 39, Issue of September 27, 2002.

Reeds were supplied from farmland in Malang, West Java, Indonesia. Manufacture of extracts and fractions include reeds dry powder was extracted by maceration using methanol at room temperature and the extract was then partitioned with n-hexana and then with ethyl acetate. The separation of ethyl acetate fraction was done by gravitation column chromatography (thin layer chromatography) until one spot compound was obtained. Determination of isolated compound structure was done by Nuclear Magnetic Resonance spectroscopy (H-NMR and C-NMR). The result of analysis showed that the isolated compound was belonged to flavonoid group, which called 7,3',5'-trimetoxyflavonol.

We use floxuridine as standart ligand. The structures floxuridine and 7,3',5'-trimetoxyflavonol constructed using Swiss model and evaluated by PROCHECK. In silico docking studies were carried out using AutoDock 4.2, based on the Lamarckian genetic algorithm principle and PyMol. Three important parameters like binding energy, inhibition constant and intermolecular energy were determined.

3. Result and Discussion

Human Thymidylate Synthase (TS) is an intracellular enzyme that provides the sole de novo source of thymidylate, making it a required enzyme in DNA biosynthesis with activity highest in proliferating cells. The methylation of deoxyuridine monophosphate to deoxythymidine monophosphate is an essential step in the formation of thymine nucleotides. This process is catalyzed by thymidylate synthase, a homodimer composed of two 30 kDa subunits. Human Thymidylate Synthase is also an important target for anticancer agents such as 5-fluorouracil. Thymidylate Synthase inhibitors are a new class of compounds that target TS. By inhibiting Thymidylate Synthase, these agents decrease thymidylate synthesis. Prior empiric approaches to anticancer drug discovery, the development of new TS inhibitors was based on the targeted and specific design molecules and relied on structure, conformation, and properties of TS¹¹.

Genetic variants of dTMP synthase have been reported. Heidelberger *et al.* reported a possible alteration in the substrate-binding site of dTMP synthase in Ehrlich ascites carcinoma cells, rendering the cells resistant to fluoro-pyrimidines. Similarly, resistance of a human lymphocytic leukemia cell line to FdUrd has been implicated in an alteration in dTMP synthase, causing the enzyme to have a lower affinity for nucleotides. Barbour *et al.* have suggested that a single amino acid substitution in an altered dTMP synthase enzyme from a human colon tumor cell line HCT116 may confer resistance on FdUrd. In the HCT116 enzyme, replacement of tyrosine by histidine at position 33, which is an evolutionarily conserved site, conferred reduced affinity on both¹².

In some patients, prolonged exposure to a single chemotherapeutic agent may lead to the development of resistance to multiple other structurally unrelated compounds. Chemotherapy resistance remains a major problem to the effective treatment of many tumor types. Resistance can occur prior to drug treatment or may develop over time following exposure. Several mechanisms, including alterations in drug pharmacokinetic and metabolism, modification of drug target expression or function, drug compartmentalization in cellular organelles, altered repair of drug-induced DNA damages, changes in apoptotic signaling pathways or expression of proteins directly affecting cellular drug transport are responsible of anticancer drug resistance¹².

195

Resistance to chemotherapy presents a major obstacle to attempt to improve the prognosis of patients with Gestational trophoblastic disease. Accordingly, it is important for the management of Gestational trophoblastic disease to elucidate the mechanisms of chemoresistance and to get over the resistance. Recently, the biological characteristics of Gestational trophoblastic disease have been molecular targeted agents including signal transduction inhibitors and anti proliferatif agent.

Women with high-risk Gestational trophoblastic disease present considerable difficulty in management and require combination chemotherapy with a selective use of surgery and radiotherapy. This group may include patients with metastases to the brain, liver, and gastrointestinal tract; complications such as massive bleeding may occur early in the course of the disease. These patients are also likely to develop drug resistance after prolonged chemotherapy².

1 The standard chemotherapy regimen for Gestational trophoblastic disease with high risk of metastatic process is EMA/CO11 (etoposide, dactinomycin, and methotrexate alternated at weekly intervals with vincristine and cyclophosphamide). Newlands *et al.* reported a five-year survival rate of 86%. Adverse prognostic variables are liver metastases and brain metastases. Gestational trophoblastic disease Drug resistance developed in 17% of patients, of whom 70% were salvaged with additional chemotherapy or surgery².

Tabel 1. Binding energy, Inhibition constant and Hidrogen bond parameter result

TS mutant	ΔG		K_i		Hidrogen Bond	
	Floxuridine	Flavonol	Floxuridine	Flavonol	Floxuridine	Flavonol
Single mutant						
E23G,	-3.70	-4.91	1.94 mM	250.28 μ M	3	2
V84A,	-3.25	-5.61	4.15 mM	77.59 μ M	2	2
D110E,	-4.01	-5.43	1.16 mM	104.09 μ M	4	2
H250L	-3.61	-5.35	2.28 mM	120.68 μ M	2	1
Double mutant						
T53S,Y258F	-4.08	-5.29	1.02 mM	131.96 μ M	1	1
Triple mutant						
A17T, D11G,D254E	-3.70	-5.36	1.95 mM	117.85 μ M	4	1

3

Automated docking was used to locate the appropriate binding orientations and conformations of Flavonol in the 1JU6 binding pocket. To perform the task, genetic algorithm implemented in AutoDock. In this docking simulation, semiflexible docking protocols were used, in which the protein structures were kept rigid and the TS being docked was kept flexible. Blind docking was performed using grid point value (X, Y and Z) of 100Å. The grid dimensions were, X=22, Y=22, Z=20, and spacing between the grid points was 0.375Å. All water molecules were removed from the original Protein Data Bank file. Polar hydrogen atoms were added and Kollman charge, atomic solvation parameters and fragmental volumes were assigned to the protein. All torsions were allowed to rotate during docking.

Lamarckian genetic algorithm was selected for ligand conformational searching and default docking parameters were used. The best docked complexes based on the lowest binding energy were further analyzed for hydrogen bonding interactions and the binding energy of human thymidylate synthetase mutant and Flavonol was compared. Finally, the Protein-ligand complexes were analyzed using Discovery Studio Visualizer and PyMOL visualization tool. The same docking simulation approach was performed with other mutants.

The amino acid residues Arg50, Leu192, Cys195, His196, Gln214, Arg215, Ser216, Asp218, Asn226, His256, and Tyr258 were assigned as catalytic region as these residues were proven to be potentially active site. All mutant selected was not on active site, but its conformation make change on amino acid residue that make Van der waals bond. Docking simulation of 7,3',5'-trimetoxyflavonol into Human Thymidylate Synthetase selected mutant binding energy and inhibition constant result presented in Table 1. High result on amino acid residue that make van der wals bond was found at T53S,Y258F mutant from 2 to 3 bond, D110E mutant from 3 to 5 bond, H250L mutant from 3 to 4 bond.

Tabel 2. Amino acid residue that involved in VDW bond between TS mutant and Flavonol

TS mutant	VDW AA bond (TS - Flavonol)
Single mutant	
E23G,	Arg50*, Arg215*, Leu221, Gly222, Phe225, Asn226*, Tyr299
V84A,	Arg50*, Phe91, His196*, Gln214*, Asp218*, Asn226*, Val313
D110E,	Thr51, Cys195*, Leu198, Gln214*, Asp218*, Gly222, Phe225, Asn226*, Tyr258*
H250L	Glu87, Phe91, Cys195*, His196*, Gln214*, Asp218*, Ala312
Double mutant	
T53S,Y258F	Ile108, Trp109, Gln214*, Ser216*, Gly217, Asp218*, Gly222, Ala312
Triple mutant	
A17T, D11G, D254E	Glu87, Ile108, His196*, Gln214*, Asp218*, Gly222, Phe225.

*bond with TS mutant active site

Tabel 3. Amino acid residue that involved in VDW bond between TS and Floxuridine

TS mutant	VDW AA bond (TS – Floxuridin)
Single mutant	
E23G,	ARG50*, ASP218*, GLY222, ASN226*, TRY258*
V84A,	MET31, ASN112, CYS195*, GLN214*, SER216*, ASP218*, ASN226*, ALA312
D110E,	TRP109, ASN112, ILE118, GLN214*, ASP218*, LEU221, ASN226*
H250L	TRP109, ASN112, ASP218*, HIS256*, TYR258*, MET311, ASN112
Double mutant	
T53S,Y258F	GLU87, ILE108, TRP109, HIS196*, GLY222, ASN226*, LEU221
Triple mutant	
A17T, D11G, D254E	ASP49, ASP48, ARG50*, ARG215*, HIS256*, TYR258*

*bond with TS mutant active site

The V84A TS mutant-Flavonol has lowest binding energy of -5.61 Kcal/mol and lowest inhibitory constant (Ki) of 77.59 μ M. The residues Met31, Asn112, Cys195, Gln214, Ser216, Asp218, Asn226, Ala312 interacted through 2 hydrogen bonds with Flavonol. The interaction was found to span within the chosen active site. Flavonol show interacted with Cys195, Gln214, Ser216, Asp218, Asn226 interacted with V84A TS mutant active site.

Interaction between VE23G TS mutant-Flavonol has highest binding energy of -4.91 Kcal/mol but its interaction still had lowest value compared with VE23G TS mutant-Floxuridine binding energy (-3.70 Kcal/mol). This VE23G TS mutant-Flavonol interaction binding energy resulted from Arg50, Arg215, Leu221, Gly222, Phe225, Asn226, Tyr299 van der waals bond (7 bond). It's more effective than VE23G TS mutant-Floxuridine which performed by 5 Van der waals bond (Arg50, Asp218, Gly222, Asn226, Try258).

Docking analysis show that all Flavonol-TS mutant interaction had low value of ΔG than Floxuridine-TS mutant. Sum of intermolecular energy and torsion energy was the binding energy. The negative and low value of ΔG indicated strong bonds, and demonstrated that flavonol was in a favorable conformation. Furthermore, the total inhibitory constant of V84A (-5.61 kcal/mol) was found to be lowest than other. The result also so that V84A mutant-Flavonol (-5.61 kcal/mol) had a better binding affinity than V84A mutant-Floxuridine in this analysis (-3.25 kcal/mol).

Hydrogen bonds formed between the compound and the protein contribute to the stability of the protein-ligand complexes, a large number of hydrogen bonds form more stable complexes. The results show that the D110E mutant-Floxuridine was stabilized by four hydrogen bonds. The active residues of the E23G, V84A, D110E, H250L mutant-Flavonol were also involved in two of hydrogen bonds formation, suggesting a stable complex. Therefore, in the study of protein-ligand binding mechanism, it was revealed that the triple mutant of human thymidylate synthetase has stronger interaction with floxuridine than other protein models (4 hydrogen bonds).

4. Conclusions

Imperata cylindrica pure compound-selected human thymidylate synthetase mutant docking result has more efficient than Floxuridine. These molecular docking analyses could lead to the further development of potent human thymidylate synthetase inhibitors for the treatment of Choriocarcinoma. Hence, this study demonstrates the importance of drug design studies and utility of computational tools in correlating experimental values with computational binding energy scores for the discovery of potential newer drug molecules against resistance.

Acknowledgement

The authors thank all Medical Biochemistry staff for assistance and St Khaerunnisa for providing the AutoDock program. This research declares no conflict of interest.

References

- Jiang, Lun, Jing Tao. Primary choriocarcinoma of the colon: A case report and review of the literature, *World Journal of Surgical Oncology*; 2013, p11:2.
- Gerulath. Gestational Trophoblastic Disease. SOGC Clinical Practice Guidelines, *Society of Obstetricians and Gynaecologists of Canada*, 2002.
- Desai, Nisarg. Choriocarcinoma in a 73-year-old woman: A case report and review of the literature, *Journal of Medical Case Reports*; 2010, 4:p379.
- American Cancer Society, 2010, www.cancer.org.
- Herling, A., Konig, M., Bulik, S., and Holzthutter, H.G. Enzymatic features of the glucose metabolism in tumor cells. *FEBS J*; 2011, Vol.278, No.14, p2436-2459.
- Cree, I.A. Cancer biology. *Methods Molecular Biology*; 2011, Vol.731, 1-11.
- Rochat, B. Importance of influx and efflux systems and xenobiotic metabolizing enzymes in intratumoral disposition of anticancer agents. *Current Cancer Drug Targets*. 2009, Vol.9, No.5, 652-674.
- Kawate Hisaya, Daniel M. Landis, and Lawrence A. Loeb, Distribution of Mutations in Human Thymidylate Synthase Yielding Resistance to 5-Fluorodeoxyuridine, *The Journal Of Biological Chemistry*. 2002, Vol. 277, No. 39, p 36304 –36311.

- 74
9. Middleton E, Jr., Kandaswami C. The impact of plant flavonoids on mammalian biology: Implications for immunity, inflammation and cancer. In: Harborne JB, editor. *The flavonoids advances in research since 1986*. 1st edition. London: *Chapman and Hall*. 1994. p 619–652.
10. Pascual ME, Slowing K, Carretero E, Sanchez Mata D, Villar A. Lippia: Traditional uses, chemistry and pharmacology: A review. *J Ethnopharmacol*. 2001;76:201–214. 116
11. Houghton J Peter, Atiqur Rahman, Cindy L. Will, Bruce J. Dolnick, Janet A. Houghton, Mutation(s) of the Thymidylate Synthase Gene of Human Adenocarcinoma Cells Causes a Thymidylate Synthase-negative Phenotype That Can Be Attenuated by Exogenous Foliates, *Cancer Research Journal*. 1992, 52, p558-565.
12. Hanane Akhdar, Claire Legendre, Caroline Aninat, Fabrice Morel, Anticancer Drug Metabolism: Chemotherapy Resistance and New Therapeutic Approaches. *Topics on Drug Metabolism*. 1991.



Institute of Tropical
Disease
Universitas Airlangga

in a collaboration
with



Institute for Protein Research
Osaka University

Proceeding

Molecular and Cellular Life Sciences:
Infectious Diseases, Biochemistry and
Structural Biology
MCLS 2015

ISBN 978-602-14292-4-2

Loewe Additivity Analysis to Find Synergism Ratio Doxorubicin and Quercetin

Abdul Khairul Rizki Purba^{a*}, Mustofa^b, Indwiani Astuti^b

^aDepartment of Pharmacology and Therapy, Universitas Airlangga, Surabaya 60131, Indonesia

^bDepartment of Pharmacology and Therapy, Universitas Gadjah Mada, Yogyakarta 55281, Indonesia

Abstract

Resistance to chemotherapeutic agent in cancer treatment like doxorubicin (DOX) is still being problem. The highest expression of efflux transporter P-glycoprotein (P-gp) is one of its resistance mechanisms. Quercetin (QUE) as antioxidant agent has been investigated in the ability on inhibiting this transporter. Mechanism of interaction between DOX and QUE was evaluated with the Loewe additivity methods including curve-shift analysis, combination index, and the universal response surface analysis. The cytotoxic effect in combination DOX and QUE was as concentration dependent. Interaction DOX and QUE on the cytotoxic test MCF-7 cell were most synergy at concentration DOX:QUE of 1:17.

Keywords: combination; interaction; synergic; cytotoxic; apoptosis

Nomenclature

ABC	ATP binding cassette	μM	micro-molar
CO ₂	carbon-dioxide	M	Molar
CI	combination index	mg	Milligram
DMSO	dimethyl sulfoxide	g	gram
DOX	doxorubicin	kg	kilogram
EGFR	epidermal growth factor receptor	L	litre
E max	maximum effect	mL	millilitre
ER	estrogen receptor		
FasL	Fas/Fas ligand		
HSP	heat shock protein		
IC	inhibition concentration		
MDR-1	multiple drug resistance 1		
MTT	3-(4,5-dimethylthiazol-2-yl)-2,5 diphenyl tetra-zolium bromide		
P-gp	P-glycoprotein		
PKC	protein kinase C		
QUE	quercetin		

1. Introduction

Chemotherapy was used up to 98% in patients with breast cancer, and 63% of them use a combination with DOX¹. However, the effectiveness in the administration of DOX has decreased due to resistance of cancer cell in apoptosis process. One of the mechanisms of cancer cell resistance to anticancer drugs DOX in particular was

* Corresponding author. Tel.: -

E-mail address: khairul_purba@fk.unair.ac.id

due to over-expression of MDR 1, which encoded a transporter protein P-gp. This was an ATP binding cassette transporter (ABC transporter) that played a role in extrusion (efflux) of hydrophobic anticancer drugs like DOX from cytoplasm of cancer cell².

Various strategies had been explored to reduce the resistance of cancer cell. One of strategies was the use of compounds capable of inhibiting the efflux mechanism of anticancer out of cancer cell. Some drugs had been proven inhibit efflux mechanisms such as verapamil, cyclosporine, reserpine, quinidine, yohimbine, and tamoxifen³. However, these drugs were expensive and had side effects serious enough. One of the natural ingredients that were proven to inhibit the efflux of anticancer by P-gp transporter was QUE. QUE was a flavonoid contained in many foods such as apples, berries, grapes, garlic, tea, tomatoes, grains, nuts, ginkgo-biloba, hipericum perforatum (St. John's wort), and sambucus canadensis⁴.

QUE showed to inhibit cancer cell through inhibition of PKC⁵, to suppress the activation of EGFR tyrosine kinase by inhibiting the process of fosforilization⁶, and to inhibit cell growth by binding estrogen receptors⁷. In addition, QUE could increase the expression of p53, p21, and cyclin D1 but suppress cyclin D2, A, E⁸. QUE also induces apoptosis of cancer cell by inhibiting the synthesis of HSP, increased expression of FasL, annexin V laneling, and caspase-3 activity⁹. This study evaluated the synergism ratio between DOX and QUE on MCF-7 cell. This evaluation was based on the activity of the combination of DOX and QUE on cytotoxicity and apoptosis of MCF-7 cell.

2. Methods

2.1 The chemical

DOX was in the preparation of liquid injection 10 mg/5ml, and quercetin hydrate 95%, brand sigma 337951. Concentrations of DOX and QUE dissolved in DMSO.

2.2 The cell line

This study used MCF-7 cell line to evaluate the interaction. MCF-7 was taken from a tank of liquid nitrogen and thawed in a water bath temperature of 37°C, and then centrifuged at 1200 rpm for 5 minutes. Supernatant was discarded and added medium grower with 5% FBS-containing in the culture flask. Under inverted microscope, alive cell appeared rounded, bright, and clear. The cells were incubated in 5% CO₂ 37°C incubator. The number of cells needed to test the cytotoxicity MTT methods that use as many as 10,000 cells/mL.

2.3 The cytotoxic analysis

Cytotoxicity test performed by the method of MTT using a microplate with 96 wells. Each microplate well was filled with MCF-7 cell as many as 10,000 cells. Concentrations of DOX and QUE were made with 8 dose levels with a concentration of triplet 172.42: 86.21: 43.10: 22.55: 10.78: 5.39: 2.69 and 1.35 µM for DOX and 369.53: 184.76: 92.38: 46.19: 23.10, and 11.55 µM for QUE. Microplate was incubated for 24 hours in 5% CO₂ incubator at 37°C. After 24 hours incubation, each well added 0.1 mL MTT dilution. MTT was stopped with 10% SDS in 0.1 N HCl. The results of absorbance were obtained from the ELISA reader at a wavelength of 595 nm.

2.4 Analysis of synergism concentration

Interaction between DOX and QUE was analyzed using the fixed ratio method, where the DOX and QUE concentrations were present in fixed ratios of concentrations corresponding to the IC₅₀ equivalents of single agents. The stock solutions contained 591.24; 259.62; and 147.81 µM QUE combined with 17.24 µM DOX, representing roughly DOX-to-QUE ratios of 1:34; 1:17; and 1:9. On the other hand, the stock solutions contained 73.91; 36.95; 18.48; and 9.24 µM QUE combined with 43.1 µM DOX ratios of 1:2; 1:0.8; 1:0.4; and 1:0.2. The cell was treated with serial dilutions (2-to 8-fold diluted) of the stock solutions. The controls were processed similarly but without drugs. The synergism ratio between DOX and QUE were evaluated with the Loewe additivity methods including curve-shift analysis, combination index, and the universal response surface analysis¹⁰. Analysis of combination index as calculated quantitatively between before and after the combination for each x% effect and equivalent to the IC₅₀ of DOX and QUE. The effect and combination index was calculated by equation 1 and 2 respectively. Combination index equal to 1, less than, or greater than 1 indicated the interaction of the two drugs were additive, synergy, or antagonism respectively¹¹.

$$E = E_{\max} \frac{C^n}{C_{50}^n + C^n} \quad (1)$$

$$\text{Combination index} = \frac{C_{D,X}}{IC_{X,D}} + \frac{C_{Q,X}}{IC_{X,Q}} \quad (2)$$

Universal response surface analysis was the additional analysis described by Greco *et al.* This method assumed that the concentration and effects on two-drug combination of a fixed relationship exists. Interaction parameter value of α was determined both drugs and calculated by equation 3. The interaction of these two drugs were additive if the value of α was zero, the value of α was negative or positive indicated synergism or antagonism respectively¹⁰.

$$I = \frac{C_{D,E}}{IC_{50,D}} \frac{E}{E_{\max}-E} \frac{1}{n_D} + \frac{C_{Q,E}}{IC_{50,Q}} \frac{E}{E_{\max}-E} \frac{1}{n_D} + \alpha \frac{C_{D,E}C_{Q,E}}{IC_{50,d} IC_{50,Q}} \frac{E}{E_{\max}-E} \frac{1}{n_D+1/n_Q} \quad (3)$$

Shift curve analysis was the last method to evaluate interaction. This curve provided the relationship IC_{50} equivalent and effects. The effect was calculated by equation 4. The synergistic interaction was showed if the curve with a combination was in the left side of the curve of combination and called leftward shift. In the contrast, antagonist interaction if the curve of combination was being on the right called rightward shift¹¹.

$$\text{Combination effect} = \frac{E_{\max} \frac{C_{D,X}}{IC_{50,D}} + \frac{C_{Q,X}}{IC_{50,D}} \text{ n combo}}{\frac{C_{D,X}}{IC_{50,D}} + \frac{C_{Q,X}}{IC_{50,D}} \text{ n combo} + IC_{50,combo}^{\text{ n combo}}} \quad (4)$$

3. Results and discussion

3.1. Synergism analysis

530

In the present study, the concentrations of doxorubicin to inhibit growth of 50% MCF-7 cells (IC_{50}) was 21.47 μM . On the other hand, quercetin which had IC_{50} on MCF-7 cells of 103.1 μM . The interaction between DOX and QUE analysed by measuring index of combination, analysing the universal surface response, and comparing curve the single drug with the combination. Figure 1 summarized the results of analysis of combination index. At the high quercetin concentration, the CI values were generally below 1, indicating synergy. The most synergy was in combination DOX:QUE ratio of 1:17 where the CI of all concentration produced from 10% (CI=0.83) to 90% (CI=0.97) the maximum effect under 1. All of ratio combination consistently synergy in ratio concentration produced over 50% maximum effect (Table 1 and Fig.1).

Table 1. Result of combination index analysis

Ratio D:Q	CI \pm SD								
	10	20	30	40	50	60	70	80	90
1:34	1.11 \pm 0.0	0.99 \pm 0.0	0.94 \pm 0.0	0.90 \pm 0.0	0.88 \pm 0.0	0.86 \pm 0.0	0.83 \pm 0.0	0.81 \pm 0.0	0.78 \pm 0.0
1:17	0.83 \pm 0.1	0.78 \pm 0.1	0.77 \pm 0.0	0.78 \pm 0.0	0.80 \pm 0.0	0.82 \pm 0.0	0.85 \pm 0.0	0.90 \pm 0.0	0.97 \pm 0.1
1:9	1.61 \pm 0.2	1.13 \pm 0.1	0.09 \pm 0.1	0.75 \pm 0.1	0.65 \pm 0.0	0.57 \pm 0.0	0.50 \pm 0.0	0.44 \pm 0.0	0.37 \pm 0.0
1:2	5.47 \pm 0.4	2.56 \pm 0.3	1.62 \pm 0.1	1.06 \pm 0.1	0.72 \pm 0.0	0.49 \pm 0.0	0.33 \pm 0.0	0.22 \pm 0.0	0.12 \pm 0.0
1:0.8	3.88 \pm 0.2	2.16 \pm 0.1	1.42 \pm 0.1	0.99 \pm 0.0	0.71 \pm 0.0	0.51 \pm 0.0	0.36 \pm 0.0	0.25 \pm 0.0	0.15 \pm 0.0
1:0.4	4.19 \pm 0.3	2.28 \pm 0.1	1.46 \pm 0.1	1.00 \pm 0.0	0.70 \pm 0.0	0.49 \pm 0.0	0.33 \pm 0.0	0.22 \pm 0.0	0.12 \pm 0.0
1:0.2	3.57 \pm 0.3	2.01 \pm 0.1	1.32 \pm 0.1	0.92 \pm 0.0	0.65 \pm 0.0	0.46 \pm 0.0	0.32 \pm 0.0	0.21 \pm 0.0	0.11 \pm 0.0

D: doxorubicin; Q: quercetin; CI: combination index; SD: standard deviation

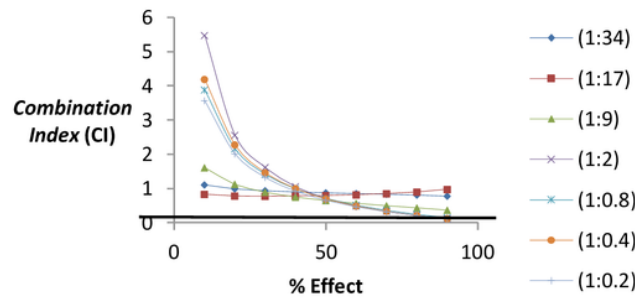

Fig. 1 Combination index curve. Less than 1 is synergy, equal to 1 is additive, and more than 1 is antagonist

Fig. 2 and Table 2 were obtained from analysis of DOX and QUE interaction with universal surface response method. The most synergy interaction was ratio 1:17 with the least negative α (-4.56) in 10% maximum effect, moreover, value of α in the ratio 1:17 was the only positive in 20% maximum effect, indicating synergy interaction. At the above of 50% effect maximum, all of ratio concentration showed synergy with a positive α .

Table 2. Result of universal surface response analysis at 10-90% maximum effect

Ratio D:Q	$\alpha \pm SD$									
	10	20	30	40	50	60	70	80	90	
1:34	-12.70 ± 0.6	-1.45 ± 0.6	0.94 ± 0.5	1.45 ± 0.6	1.50 ± 0.3	1.35 ± 0.3	1.18 ± 0.2	1.08 ± 0.2	1.16 ± 0.2	
1:17	-4.56 ± 5.5	4.86 ± 2.9	4.29 ± 1.3	2.90 ± 0.6	1.90 ± 0.2	1.12 ± 0.1	0.59 ± 0.1	0.26 ± 0.1	0.11 ± 0.1	
1:9	-20.09 ± 0.5	-3.52 ± 1.2	1.20 ± 1.3	2.99 ± 1.1	3.70 ± 0.9	3.94 ± 0.7	3.96 ± 0.5	3.94 ± 0.4	4.01 ± 0.2	
1:2	-29.54 ± 1.9	-12.38 ± 0.6	-5.20 ± 0.2	-0.57 ± 0.5	2.89 ± 0.5	5.88 ± 0.9	8.95 ± 1.1	12.91 ± 1.3	20.76 ± 1.8	
1:0.8	-72.15 ± 1.9	-24.46 ± 0.3	-8.01 ± 0.4	-0.06 ± 0.5	4.42 ± 0.5	7.18 ± 0.4	9.06 ± 0.2	10.63 ± 0.1	12.85 ± 0.2	
1:0.4	-133.14 ± 7.6	-45.80 ± 0.9	-15.26 ± 0.7	-0.28 ± 1.1	8.29 ± 1.1	13.70 ± 1.0	17.49 ± 0.9	20.76 ± 1.1	25.45 ± 1.8	
1:0.2	-296.68 ± 17.3	-92.28 ± 1.4	-25.92 ± 1.9	4.26 ± 2.6	20.00 ± 2.5	28.79 ± 2.3	33.95 ± 2.3	37.47 ± 2.8	41.99 ± 4.1	

D: doxorubicin; Q: quercetin; CI: combination index; SD: standard deviation

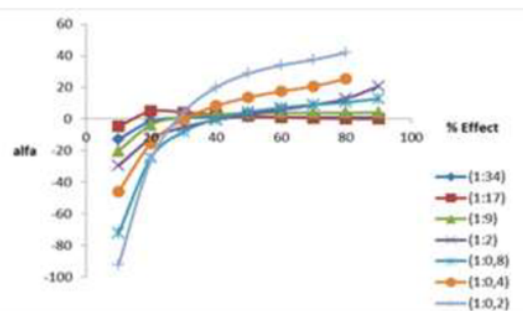

Fig. 2. Value of α of the combination doxorubicin and quercetin. The positive value is synergy, zero is the additive, and negative is antagonist.

The synergism interaction was also obtained by comparing IC_{50} equivalent each ratio with IC_{50} single concentration of doxorubicin and then plot to the curve as the nonlinear curve (Fig. 3 and Table 3). The IC_{50} equivalent indicated synergism interaction when IC_{50} equivalent of a ratio was above IC_{50} equivalent of single concentration DOX. The ratio of 1:17 was the only synergy interaction with IC_{50} equivalent of 0.53 compared in single DOX (0.52). All of ratio combination showed synergy interaction on concentration that produced above 50% maximum effect; consequently, all concentration-effect curves for various ratios in combination that caused effect above 50% were shift to the left of the curves for the single DOX. On the other hand, the curve on the right of the single DOX indicated antagonism interaction as low concentration as low effect. Figure 3 showed that the IC_{50} equivalent versus response curves for doxorubicin, quercetin, or their combinations in range of response from 10% to 90% the maximum effect.

Table 3. IC₅₀ equivalent at combination of doxorubicin and quercetin on 10-90% maximum effect

Ratio D:Q	IC ₅₀ equivalent ± SD								
	10	20	30	40	50	60	70	80	90
1:34	0.04 ± 0.0	0.12 ± 0.0	0.27 ± 0.0	0.53 ± 0.1	1.00 ± 0.1	1.91 ± 0.1	3.87 ± 0.6	8.89 ± 2.5	28.79 ± 13.5
1:17	0.14 ± 0.0	0.27 ± 0.0	0.42 ± 0.0	0.61 ± 0.0	0.88 ± 0.0	1.26 ± 0.0	1.84 ± 0.1	2.89 ± 0.1	5.40 ± 0.2
1:9	0.09 ± 0.0	0.19 ± 0.0	0.32 ± 0.0	0.52 ± 0.0	0.80 ± 0.0	1.23 ± 0.0	1.97 ± 0.0	3.42 ± 0.2	7.34 ± 0.6
1:2	0.13 ± 0.0	0.23 ± 0.0	0.34 ± 0.0	0.47 ± 0.0	0.65 ± 0.0	0.89 ± 0.0	1.25 ± 0.1	1.85 ± 0.1	3.21 ± 0.6
1:0.8	0.28 ± 0.0	0.37 ± 0.0	0.49 ± 0.0	0.60 ± 0.0	0.72 ± 0.0	0.86 ± 0.0	1.05 ± 0.1	1.32 ± 0.1	1.82 ± 0.1
1:0.4	0.18 ± 0.0	0.29 ± 0.0	0.41 ± 0.0	0.54 ± 0.0	0.71 ± 0.0	0.93 ± 0.0	1.25 ± 0.0	1.75 ± 0.0	2.81 ± 0.0
1:0.2	0.18 ± 0.0	0.29 ± 0.0	0.40 ± 0.0	0.54 ± 0.0	0.70 ± 0.0	0.91 ± 0.0	1.21 ± 0.0	1.68 ± 0.0	2.66 ± 0.1

D: doxorubicin; Q: quercetin; CI: combination index; SD: standard deviation

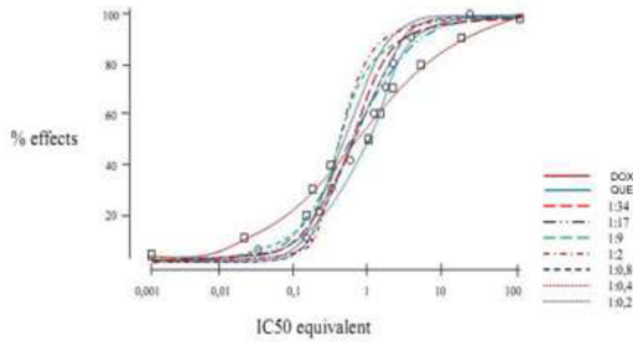

Fig. 3. Curve shift analysis of the interaction of doxorubicin and quercetin

The Loewe additivity analysis informed that interaction between DOX and QUE had range effects 10-90% effects from antagonism to synergism effects. Ratio combination 1:17 had no antagonism effect in CI and universal surface analysis but not in curve shift analysis. Synergism interaction between DOX and QUE in the three methods analysis of the Loewe additivity in the cytotoxicity effects was showed in the Table 4.

Table 4. Synergism of the interaction DOX and QUE in the cytotoxicity effects

Ratio	Analysis	Cytotoxicity effects (%)								
		10	20	30	40	50	60	70	80	90
1:34	Combination index	A	A	AD	AD	S	S	S	S	S
	Curve shift	A	A	A	AD	S	S	S	S	S
	Universal surface	A	A	S	S	S	S	S	S	S ⁰⁴
1:17	CI	AD ⁵	S	S	S	S	S	S	S	AD
	Curve shift	A	A	A	AD	S	S	S	S	S
	Universal surface	AD	S	S	S	S	S	S	S	AD
1:9	CI	A ¹⁵	A	AD	S	S	S	S	S	S
	Curve shift	A	A	A	AD	S	S	S	S	S
	Universal surface	A	A	AD	S	S	S	S	S	S
1:2	CI	A	A	A	AD	S	S	S	S	S
	Curve shift	A	A	A	AD	S	S	S	S	S
	Universal surface	A	A	A	A	S	S	S	S	S
1:0.8	CI	A	A	A	AD	S	S	S	S	S
	Curve shift	A	A	A	AD	S	S	S	S	S
	Universal surface	A	A	A	AD	S	S	S	S	S
1:0.4	CI	A	A	A	AD	S	S	S	S	S
	Curve shift	A	A	A	AD	S	S	S	S	S
	Universal surface	A	A	A	AD	S	S	S	S	S
1:0.2	CI	A	A	A	AD	S	S	S	S	S
	Curve shift	A	A	A ⁶	AD	S	S	S	S	S
	Universal surface	A	A	A	S	S	S	S	S	S

CI: combination index; A: antagonism; AD: Additive; S: Synergy

3.2. Apoptosis effect in synergism concentration

Apoptosis test was performed in the ratio DOX and QUE which in the most synergy ratio of 1:17. In the apoptosis test, MCF-7 cells was observed under flourescence microscope after double staining and showed in Fig. 4.

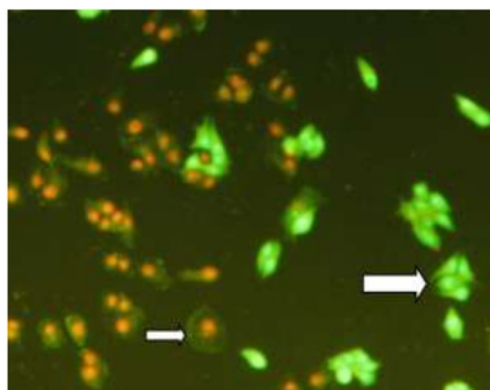

Fig. 4. Apoptosis effect on MCF-7 in the combination DOX and QUE with acridine orange and ethidium bromide staining. A thick arrow indicated viable cells and a thin arrow showed apoptotic cell.

The percentage of apoptotic MCF-7 cell in concentration of combination ratio 1:17 is no significance difference with either single IC_{50} DOX ($p=0.783$) and IC_{50} QUE ($p=0.869$). However, amount of apoptotic cells in single concentration DOX or QUE in ratio of 1:17 was decrease significance statistically from in combination ratio 1:17. Amount of apoptotic cells showed in Table 5.

Table 5. Percentage of apoptotic cells

Drugs	Concentrations (μ M)	Apoptotic cell (%) \pm SD	P
Control	0	0	
DOX	21	50.11 \pm 1.95	0.783
DOX (1:17)	3.74	28.22 \pm 2.46	0.001*
QUE	103	50.33 \pm 0.67	0.869
QUE (1:17)	64.04	39.22 \pm 2.14	0.010*
DOX:QUE(1:17)	3.74:64.04	50.67 \pm 3.76	Ref

*statistically significance difference ($p<0.005$)

The report explored interaction between DOX and QUE on cytotoxic effect on MCF-7 human breast cancer cell line with different methods. Quercetin IC_{50} of less than 147.81 μ M quercetin was considered that quercetin can be as anti-proliferative from natural derivatives¹².

Test cytotoxic activity of DOX and the combination with QUE on MCF-7 cells with the MTT assay method were conducted to analyse the evaluation of the interaction of DOX and QUE. Concentration ratio of DOX and QUE in combination was based on the exploration on 7 ratios of 1:34; 1:17; 1:9; 1:2; 1:0.8; 1:0.4; 1:0.2. Test the interaction between DOX and QUE performed on the combination index, universal surface analysis, and curve shift analysis¹⁰. This study was also proved the basic concept about the relationship concentration and effect as the occupational theory, which the higher concentration, the higher effect¹³. However, each range of concentration in combination had interaction likely antagonist, additive, or synergy as this study found.

The first method to test the interaction of DOX and QUE on cytotoxicity of MCF-7 cells were analysed by the combination index method. It was a quantitative calculation of IC_{50} between the concentration of single and combination concentration. This method was to know the interaction of DOX and QUE at 10% to 90% maximum effect of inhibitory on MCF-7 cells. Combination index analysis results showed that the interaction DOX and QUE was synergy at concentrations that caused effects above 50% maximum effect. CI decreased followed by increasing in effect. CI in ratio 1:17 is the most synergy because this ratio was the first having CI under 1 in the lowest concentration.

The evaluating the interaction of DOX and QUE in MCF-7 cell cytotoxicity with response surface method was an additional analysis and introduced by Greco *et al.* In this method the interaction parameters of both drugs was determined by the value of alpha (α). The calculation of the value of α was based on equations derived from equation of the hill. A value around 10-30% at a concentration ratio of the maximum effect showed an antagonistic interaction, at 40% maximum effect showed an additive interaction, and above 50% maximum effect showed synergistic interaction. Ratio 1:17 had also the most synergy compared the others.

The last method was the curve shift analysis. Each curve of the combination compared to the curve DOX and QUE in single dose. The whole curve to the effects on the entire concentration ratio showed the consistent of results. Antagonistic and synergic interaction respectively occurred at concentrations causing effects combination of less than 30% and above 50% of maximum effect. It was characterized by curve combinations of DOX on the leftward. The most synergistic effect obtained from the data ratio of DOX:QUE on 1:17.

Overall, the interaction mechanism was on the concentration or dose dependent. Antagonistic interactions were occurred at low concentrations, ie concentrations that produced effects below 30% maximum effect. Synergistic interaction occurred at high concentrations, the concentrations that produced effects above 50% maximum effect. The observations of combination index, the universal response surface analysis and curve shift analysis were compared with each other. The result of all method consistently agreed that the ratio DOX and QUE of 1:17 on the inhibition of MCF-7 cells was the most synergy. Synergistic interaction between QUE and DOX occurred through the mechanism of competition for P-gp transporter. Doxorubicin was a P-gp substrate and increased the activity of P-gp H types, whereas QUE inhibited P-gp by binding to H type so that the efflux by P-gp was inhibited. The inhibition of P-gp activity by QUE could increase the concentration of DOX in cancer cells¹². According to the analysis of combination index analysis, analysis of universal surface response, and the shift curve analysis showed that the antagonistic interaction occurred at concentrations that pose a combination of effects below 30% maximum effect. On the low effects, the concentrations of quercetin doxorubicin were also low because both drugs were dose dependent. At low concentrations, QUE had a proliferative effect on MCF-7 cells through stimulation of the ER. At low concentrations of QUE increased the number of free estrogen receptors in the absence of quercetin-binding. Thus, growth factors can trigger stimulation that result in signal transduction was occurred¹⁴. Mechanism QUE and DOX in estrogen receptors still need depth exploration.

4. Conclusions

The interaction between DOX, as chemotherapy in cancer, with QUE, as P-glycoprotein blocker, in cytotoxic effect in MCF-7 cells was as concentration dependent. This interaction was synergy when the concentration of quercetin was higher, but in the lower concentration of quercetin could cause an antagonistic interaction. The most synergy interaction DOX and QUE was in ratio 1:17. Furthermore, this ratio had been tasted in the apoptosis evaluation result in no significance difference between combination and single drug producing 50% apoptotic cell in MCF-7.

Acknowledgements

The authors thank to Miss Juana as technician of laboratory at Faculty of Medicine University of Gadjah Mada.

References

- Hancke K, Denking MD, König J, Kurzeder C, Wöckel A, Herr D, *et al*. Standard treatment of female patients with breast cancer decreases substantially for women aged 70 years and older: a German clinical cohort study. *Ann oncol*. 2010. 21 (4):748-53.
- Pasquier J, Magal P, Boulangé-lecomte C, Webb G, and Le Foll F. Consequences of cell-to-cell P-glycoprotein transfer on acquired multidrug resistance in breast cancer: a cell population dynamics model. *Biol Direct*. 2011. 1 (6):1-18.
- Dantzig AH, de Alwis DP, Burgess M. Considerations in the design and development of transport inhibitors as adjuncts to drug therapy. *Adv Drug Deliv Rev*. 2003. 55 (1): 133-50.
- Williamson G, Manach C. Bioavailability and bioefficacy of polyphenols in humans. II Review of 93 intervention studies. *Am J Clin Nutr*. 2005. 81 (1 suppl): 243S-55S.
- Agullo G, Gamet-Payrastré L, Manenti S, Viala C, Rémésy C, Chap H, Payrastré B. Relationship between flavonoid structure and inhibition of phosphatidylinositol 3-kinase: a comparison with tyrosine kinase and protein kinase C inhibition. *Biochem Pharmacol* 1997. 53 (11): 1649-57.
- Lee LT, Huang YT, Hwang JJ, Lee PP, Ke FC, Nair MP, Kanadaswam C, Lee MT. Blockade of the epidermal growth factor receptor tyrosine kinase activity by quercetin and luteolin leads to growth inhibition and apoptosis of pancreatic tumor cells. *Anticancer Res* 2002. 22 (3):1615-27.
- Mense SM, Chhabra J, Bhat HK. Preferential induction of cytochrome P450 1A1 over cytochrome P450 1B1 in human breast epithelial cells following exposure to quercetin. *J Steroid Biochem Mol Biol*. 2008. 110 (1-2): 157-62.
- Wu LC, Lu IW, Chung CF, Wu HY, Liu YT. Antiproliferative mechanisms of quercetin in rat activated hepatic stellate cells. *Food Funct*. 2011. 2 (3-4): 204-12.
- Aalinkel R, Bindukumar B, Reynolds JL, Sykes DE, Mahajan SD, Chadha KC, Schwartz SA. The dietary bioflavonoid, quercetin, selectively induces apoptosis of prostate cancer cells by down-regulating the expression of heat shock protein 90. *Prostate*. 2008. 68(16):1773-89.
- Zhao L, Au JL, Wientjes MG. Comparison of methods for evaluating drug-drug interaction. *Front Biosci (Elite Ed)*. 2010. 2: 241-9.
- Zhao L, Wientjes MG, Au JL. Evaluation of combination chemotherapy: integration of nonlinear regression, curve shift, isobologram, and combination index analyses. *Clin Cancer Res*. 2004. 10 (23): 7994-8004.
- Mans DR, da Rocha AB, Schwartzmann G. Anti-cancer drug discovery and development in Brazil: targeted plant collection as a rational strategy to acquire candidate anti-cancer compounds. *Oncologist*. 2000. 5 (3): 185-98.
- Hömer LD. The receptor occupation theory of drug responses. *J Theor Biol*. 1967. 17 (3): 399-409.
- Van der Woude H, Ter Veld MG, Jacobs N, van der Saag PT, Murk AJ, Rietjens IM. The stimulation of cell proliferation by quercetin is mediated by the estrogen receptor. *Mol Nutr Food Res*. 2005. 49 (8): 763-71.



Institute of Tropical
Disease
Universitas Airlangga

in a collaboration
with



Institute for Protein Research
Osaka University

Proceeding

Molecular and Cellular Life Sciences:
Infectious Diseases, Biochemistry and
Structural Biology
MCLS 2015

ISBN 978-602-14292-4-2

Preventive Effect of *Marsilea crenata* Leaves and Stalks Juice Against Urolithiasis in RATS (*Rattus norvegicus* Wistar Strain)

Sri Murwani^{a*}, Pratiwi Trisunuwati^b, Lelyta Damayanti^c, Jefri Hardiyanto^c, Bonanza
Wahyu Pradana^c, Mardiana Kusumawati Karsono^c

^aLaboratory of Microbiology and Immunology, Veterinary School, Brawijaya University, Malang, Indonesia

^bLaboratory of Epidemiology, Husbandry Faculty, Brawijaya University, Malang, Indonesia

^cStudents of Veterinary School, Brawijaya University, Malang, Indonesia

Abstract

Urolithiasis frequently as an impact of dry food given regularly, keeping animals so the movement becomes restricted, lack of water intake, by microbial infection. *Marsilea crenata* contains some compounds have function as diuretic, antioxidant, antiinflammatory. The research purpose was to determine potency of the *M. crenata* leaves and stalks juice to prevent urolithiasis in vivo. Research was true experimental, by complete random design. Males *Rattus norvegicus*, divided into: negative control; positive control urolithiasis (given 0.75% ethylene glycol/EG, 2% ammonium chloride/AC, 2 ml/ day, for 10 days); four groups of preventive controls (given different dose juice of *M. crenata* and 0.75% EG + 2% AC). Parameters: urine quality; proinflammatory cytokines; free radicals; kidney and gall bladder histopathologic. Results, *M. crenata* leaves and stalks juice increased urine quality and SOD, decreased IL-1 β , TNF- α and MDA, and prevented kidney and gall bladder from tissue damage. Concluded, *M. crenata* leaves and stalks juice have preventive function against urolithiasis in rats animal model.

Keywords: preventive; urolithiasis; *Marsilea crenata*

1. Introduction

Urolithiasis is a pet animals common disease, particularly occur in dogs and cats. It is caused by deposit crystal in urinary tract and sediment urine minerals. Urolithiasis caused *feline lower urinary tract disease* and *idiopathic cystitis*.

The Ohio State University Veterinary Hospital evaluates 109 cats with stranguria and 15 cats of them are urolithiasis¹. *Waltham Centre for Pet Nutrition* reported, the newest case of *feline lower urinary tract disease* is 0.5-1% /year from cat population in Europe and South America.

The common crystal is calcium oxalate (CaOx) and magnesium ammonium phosphate (MAP). Treatment of urolithiasis done by administration drugs and using catheter. But after treatment the urolithiasis can be occur again. Sparkes and Philippe² reported that 20-50% of urolithiasis in cat and dog are relapse, if no preventive properly.

Nowadays some traditional herbs, such as kumis kucing (*Orthosiphon aristatus*), blue grapes fruit (*Vitis vinifera* L.), and tempuyung leaves (*Sonchus arvensis*) contain substances that play as preventive agent against infection or disease. Water semanggi (*M. crenata*) is one of wild plant suspected contain active chemical substances able to destroy crystal urolithiasis.

Juice of leaves and stalks *M. crenata* contain chemical active substances suspected can prevent urolithiasis. These substances are: K⁺ ions and flavonoid have diuretics function, as antioxidant, antiinflammation; alkaloid and polyphenols antioxidant.

In this research, was used white rats (*R. norvegicus*) Wistar strain as urolithiasis animal model. These animals were inducing with combination of 0.75% EG and 2% AC. Base on Jagannath research³, administration this

* Corresponding author. Tel.: -

E-mail address: muratinia@hotmail.com

combination for ten days can induce forming of CaOx crystals. Research objective is juice of leaves and stalks water semanggi (*M. crenata*) can be used to prevent urolithiasis in white rats (*R. norvegicus*) Wistar strain? Research purposes is to prove the ability of water semanggi (*M. crenata*) to prevent urolithiasis in white rats (*R. norvegicus*) Wistar strain, base on: urine quality, level of inflammatory cytokines, level of free radicals, and kidney and gall bladder histopathology. Research usefulness is base for next research about the toxicity effect of *M. crenata* and base for herbs improvement as alternative drugs.

2. Methods

2.1. Sample

Inclusion criteria: Health male rats, 175-200 gr BW, and 12 weeks old. The animal was obtained from Unit Pengembangan Hewan Percobaan (UPHP) Gadjah Mada University, and had certificated by The Ethical Committee Medical Research of Medical Faculty Brawijaya University (No. 421/EC/KEPK/07/2013). Number of samples: $p(n-1) \geq 15^4$. The animal were adapted for 7 days before treatment (Lina *et al*, 2003) and placed in metabolic cage.

2.2. Variables

Dependent variable: urine quality, inflammatory cytokines, free radical, and kidney and gallbladder histopathology. Independent variable: *M. crenata*, EG, AC. Control variable: homogeneity of the animal model, diet, *M. Crenata*.

2.3. Dose juice of leaves and stalks *M. crenata*

The doses are 5%, 10%, 20%, 40% (modified Purwono, 2010)⁵.

2.4. Dose of ethylene glycol (EG) and ammonium chloride (AC)

Combination of 0.75% EG and 2% AC was used to induce urolithiasis (modified Anggraeni, 2013)⁶.

2.5. Juice of leaves and stalks *M. crenata*

The herb was obtained from UPT. Matrika Medika Batu, East Java, Indonesia. The juice was made using fruit juicer without dilution, so the concentration is 100%.

2.6. Treatment

Table 1. Groups of treatment

Group	Treatment
Negative control	Normal condition (normal diet)
Positive control	Normal diet + 0.75% EG + 2% AC
Treatment 1	Normal diet + 5% juice <i>M. crenata</i> + 0.75% EG + 2% AC
Treatment 2	Normal diet + 10% juice <i>M. crenata</i> + 0.75% EG + 2% AC
Treatment 3	Normal diet + 20% juice <i>M. crenata</i> + 0.75% EG + 2% AC
Treatment 4	Normal diet + 40% juice <i>M. crenata</i> + 0.75% EG + 2% AC

The treatment was done for 10 days orally using stomach sonde.

2.7. Urine sampling

The urine was collected at 11th of day⁵. Volume, pH, specific gravity, bilirubin were analysed using Urine Analyser (Sacher *et al.*, 2002). Urine sediments were examined using Gandasoebrata method⁷.

2.8. Level of TNF- α and IL-1 β

Euthanasia the animal models were done by cervical dislocation. The serum was collected for ELISA.

2.9. Level of MDA and SOD

The kidney MDA and the serum SOD were measured by spectrophotometry method (Laboratory of Pharmacology, Medicine Faculty, Brawijaya University, 2013).

2.10. Histopathology of kidney and gallbladder

The tissues were stained using haematoxylin-eosin.

2.11. Data analysis

The data was analysed using one-way ANOVA and Kruskal-Wallis with $\alpha = 0.05$.

3. Results and discussion

3.1. Urine examination

3.1.1. Urine pH

Gandasoebrata (1992)⁷, normal rat pH urine is 4.6-8.5. Urine pH group with *M. crenata* 5%, 10%, 20%, 40% increase significantly (Table 2). It is may cause by K⁺ ions in leaves and stalks of *M. crenata*, and the highest at the 40%. Huang, *et al.* (2006)⁸, explained that combination 0.75% EC and 2% AC caused chronic hyperoxaluric, with base urine. Base pH urine can promote forming of crystals CaOx in urine. Parmar *et al.* (2012)⁹, in CaOx urolithiasis was found at normal until base. Different with uric acid urolithiasis, causing by crystals of uric acid, occur in acid urine¹⁰.

Table 2. pH urine

Group	Mean \pm SD pH urine
Negative control	7.13 \pm 0.25 ^a
Positive control	7.50 \pm 0.41 ^{ab}
5% of <i>M. crenata</i>	7.63 \pm 0.25 ^{ab}
10% of <i>M. crenata</i>	7.63 \pm 0.25 ^{ab}
20% of <i>M. crenata</i>	7.75 \pm 0.29 ^{ab}
40% of <i>M. crenata</i>	7.88 \pm 0.25 ^b

Excess of K⁺ ions in body will be eliminating via urine and sweat²⁹. K⁺ ions are strong base increasing urine pH animal model¹¹. Increasing of the urine pH insignificantly at group with *M. crenata*, and unable influenced kidney function in regulation of H⁺ and HCO³⁻ body fluid animal models urolithiasis. Guyton and Hall (1997)¹², base and acid urine regulation by the kidney is a one of important body mechanism to stabilizing body pH. Kidney controls the urine acid-base by releasing through urine and depends on acid-base extracellular body fluid. The role of this control is by secretion of hydrogen ions, reabsorbs bicarbonate ions and production of new bicarbonate ions. Factors influencing acid secretion by kidney are changes of K⁺ ions, CO₂ intracellular pressure, level of anhydrase carbonate and some hormone such as aldosterone, steroid adrenocortex, angiotensin II¹³.

3.1.2. Specific gravity

Kidney damage induced by combination EG and AC decrease urine specific gravity in male rats^{14,15,16}, specific gravity human and animal urine under 1,015 (\pm 1,010) indicated strong kidney tissue damages. Its may caused by alternation of reabsorption function the kidney at proximal tubules, henle loop, distal tubules, or colectivus tubules.

Administration of juice leaves and stalks *M. Crenata* induced increasing significantly the specific gravity the urine. Specific gravity depends on urine indigrient and volume. In this research suggested influence by fragments calcium and oxalate in the urine.

3.1.3. Urine bilirubin

Bilirubin is form of haemoglobin degradation product in reticuloendothelial. Bilirubin absent in healthy animals urine, but find in individual with urinary tract disease, liver disease, and may associated with other body system¹⁷.

In this research the juice of leaves and stalks *M. crenata* has effect reduces level bilirubin in the urine, that indicated the urinary tract tissues damage was decrease or with other body system associated with bilirubin production.

3.1.4. Urine CaOx sediments

Juice of leaves and stalks of *M. crenata* can destruct urine CaOx crystals. It is may caused by diuresis effect of the juices. It showed by decreasing of urine sediments significantly (Fig. 3).

In this research, in urine also found struvite crystals in each group of treatment. Struvite crystals may present normally in some animal as body waste metabolic product¹⁸. No uric acid and cystin crystals in urine. Crystal uric acid just find in acid urine¹⁹, and cystinin autosomal recessive individual (Orson, 2006). Crystal CaOx_{≤5}-may normal in healthy animals⁷.

Urine sediment examination is one of important laboratory diagnosis for urinary tract diseases. K⁺ and Na⁺ ions balance kidney electrolytes. K⁺ ions from *M. crenata* juices bind to oxalate acid or uric acid, then was dissolved the crystals be acid substances that water-soluble. Crystal fragments will go out the body with urine. The reaction²⁰:

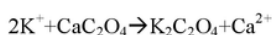

CaC₂O₄ or oxalate stone sediments are water-soluble. K ions inhibit combining of Ca⁺ ions with carbonate, oxalate or uric and until Ca⁺ become soluble²⁰.

Juice of leaves and stalks *M. crenata* also contain flavonoid. CaOx crystal may combine with -OH of flavonoid and form Ca-flavonoid complexes, it may cause more water-soluble and easily go out when urination. Flavonoid also plays as diuretic substance²¹.

616

3.2. Level of TNF- α and IL-1 β

526

By one-way ANOVA and Tukey, $\alpha = 0.05$, the level of inflammatory cytokines (TNF- α and IL-1 β) decreased following the increasing of juice *M. crenata* administration (Table 3).

Table 3. Level of TNF- α

Group	Mean \pm SD TNF- α (μ g/ml)	Mean \pm SD IL-1 β (μ g/ml)
Negative control	42.75 \pm 0.65 ^a	0.95 \pm 0.03 ^a
Positive control	95.63 \pm 4.21 ^d	2.07 \pm 0.06 ^d
5% of <i>M. crenata</i>	77.38 \pm 1.89 ^c	1.67 \pm 0.04 ^c
10% of <i>M. crenata</i>	73.88 \pm 1.70 ^c	1.66 \pm 0.03 ^c
20% of <i>M. crenata</i>	65.13 \pm 0.85 ^b	1.23 \pm 0.03 ^b
40% of <i>M. crenata</i>	47.50 \pm 1.68 ^a	1.17 \pm 0.02 ^b

Concentration 5% and 10% juice *M. crenata* showed have same effect on TNF- α level. The highest TNF- α is at 40%. Jagannath, *et al*³, combination of 2% EC and 0.75% AC in 10 days induce increasing of urine calcium and oxalate, and CaOx crystals. The crystals caused ureter obstruction lead to urolithiasis. It's trigger inflammation responses sign by high inflammatory cytokines, TNF- α and IL-1 β .

Flavonoid as antiinflammation induced decreasing the production and releasing of TNF- α and IL-1 β by immune cells. These responses are influenced by inhibition and inactivation effect to *protein tyrosine kinase* (PTK) p56²², and blocked transcription and translation process of cytokines²³.

3.3. Level of MDA and SOD

The result showed that the MDA level decreased after administration of *M. crenata*, oppositely to the SOD level (Table 4).

Table 4. Level of MDA and SOD

Group	Mean \pm SD MDA (ng/ml)	Mean \pm SD SOD (u/ml)
Negative control	125.88 \pm 6.57 ^a	14.40 \pm 0.28 ^d
Positive control	197.13 \pm 9.44 ^e	9.97 \pm 0.70 ^a
5% of <i>M. crenata</i>	179.00 \pm 6.12 ^d	10.50 \pm 0.37 ^a
10% of <i>M. crenata</i>	169.00 \pm 13.07 ^e	11.73 \pm 0.52 ^b
20% of <i>M. crenata</i>	151.50 \pm 6.12 ^b	13.12 \pm 0.50 ^a
40% of <i>M. crenata</i>	125.25 \pm 3.23 ^a	14.18 \pm 0.10 ^d

Urolithiasis patients cannot urine normally. This condition induces generation of reactive oxygen species

(ROS). ROS is very reactive, causing tissue injury and failure of cells function. ROS activate nuclear factor kappa B (NF- κ B) and *I κ B kinase* (IKK) regulators. IKK is a complex of enzyme can induce cellular inflammation responses. IKK induce forming of I κ B α , which bind to NF- κ B as mediator of cells proliferation, inflammation responses, and apoptosis factors²⁴.

High-level ROS in the body tissues cause oxidative stress may induce increasing of lipid metabolic product, malonyldyaldehyde (MDA). High level of MDA is one of predictor cellular tissues damage by free radicals²⁵.

Flavonoid in juice of leaves and stalks of *M. crenata* has antioxidant and antiinflammation functions. As antioxidant, it has either directly or indirectly effect. Directly, by donor its hydrogen ions to neutralized toxic effect of ROS. Flavonoid also acts as chelating agent of O-in nitrite peroxide (ONOO-)²⁶. Indirectly, by enhancing of endogenous antioxidant gene through some mechanisms, such as activation of *nuclear related factor 2* (Nrf2) that induce synthesis of endogenous antioxidant enzyme gene of *superoxide dismutase* (SOD). SOD play as free radicals scavenger^{27,28}.

3.4. Histopathology of kidney and gallbladder

The tissue damage was scored and analyzed statistically using Kruskal-Wallis. Results showed, that the kidney and gallbladder damages decrease significantly after administration juice leaves and stalks *M. crenata*. Combination 0.75% EG and 2% AC induce urolithiasis, showed by kidney and gallbladder tissues damage, including inflammation, hemorrhagic, lipid degeneration, necrosis, and edema (Fig. 1).

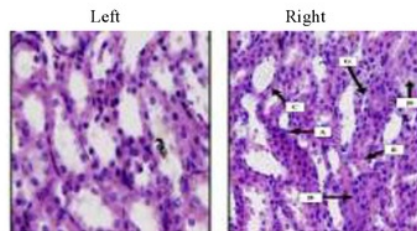

Fig. 1. Left: normal kidney tubule; Right, positive control A. Inflammation; B. Hemorrhage; C. Crystals; D. Lipid degeneration; E. Necrosis; G. Edema (400x magnification)

Tissue damages may be caused by toxic effect of EG and AC, inflammation process, free radicals, and traumatic effect of urolithiasis. Higher concentration of the juice cause lower tissue damage. Effect antioxidant and antiinflammation of juices leaves and stalks *M. crenata* prevent progression of tissue damage. The highest tissue damage is control positive, and the lowest is group 15% *M. crenata* (Fig. 2 and 3).

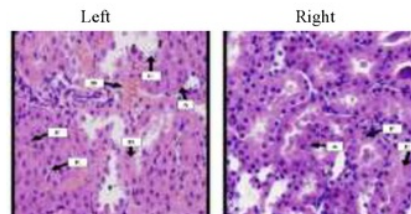

Fig 2. Left, Kidney tubules; 5% *M. crenata*: A. Inflammation; B. Hemorrhage; C. Crystals; D. Lipid degeneration; E. Necrosis; F. Hydropic degeneration; Right, kidney tubule, 10% *M. crenata*: A. Inflammation; B. Necrosis; F. Hydropic degeneration) (400x magnification)

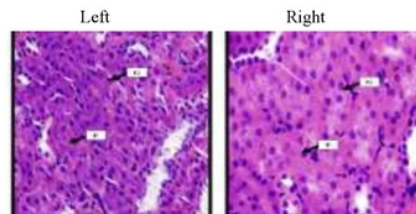

Fig 3. Left, kidney tubule, 20% *M. crenata*. E. Necrosis, F. Hydropic degeneration; Right, kidney tubule, 40% *M. crenata*. E. Necrosis, F. Hydropic degeneration (400x magnification)

4. Conclusion

From this research, can be concluded that juice of leaves and stalks *M. crenata* have prevention effect against in *R. Novergicus* animal model.

References

1. Buffington, C.A.T. *Managing common chronic lower urinary tract disorders of cats*. Proceedings of the North American Veterinary Conference. Orlando. 2001. pages 282-285.
2. Sparkes, A.H. dan Philippe, C.J. *Urolithiasis in Cats: Managing The Risks*. Nestle Purina Pet Care. 2008. 1-7.
3. Jagannath, N., Somashekara, S.C., Damodaram G., and Golla D. Study of antiurolithiatic activity of *Asparagus racemosus* on albino rats. *Indian Journal of Pharmacology*. 2012. **44**: 576-579.
4. Kusningrum. *Perancangan Percobaan*. Airlangga University Press. Surabaya. 2008.
5. Purwono, R. M. *Pengaruh Infusum Daun Alpukat (Perseaamericana Mill) dalam Menghambat Pembentukan Kristal pada Ginjal Tikus*. Institut Pertanian Bogor. 2009.
6. Anggraini, S. Uji Aktivitas Penghambatan Batu Ginjal (Anti Nefrolithiasis) Ekstrak Etanol Dari Herbal Pegagan *Centellaasiatica* L. Urban Pada Tikus Jantan. *Scientific Journals of Bogor Agricultural University*. 2013. **2**(1): 1-5.
7. Gandasoebatra. *Penuntun Laboratorium Klinik*. PT Dian Rakyat. Jakarta. 1992.
8. Huang, H.S., Chen, J., Chen, C.F., and Ma, M.C. Vitamin E Attenuates Crystal Formation in Rat Kidneys: Roles of Renal Tubular Cell Death and Crystallization Inhibitors. *Kidney Int*. 2006. **70**(4): 699-710.
9. Parmar, R. K., Kachchi, N. R., Tirgar, P. R., Desai, T. R., and Bhalodiya, P. N. Preclinical Evaluation of Antiurolithiatic Activity of *Swertia Chirata* Stems. *International Research Journal of Pharmacy*. 2012. **3**(8).
10. McCann, J. A. and Schilling, R. N. *Professional guide to diseases*. 8th ed. Lippincott Williams and Wilkins Publishers. London. 2005.
11. Tanagho, E.A., McAninch and JW Smith. *General Urology*, 15 edition. McGraw-Hill Company. New York. 2000.
12. Guyton, A. C and Hall, J. E. *Fisiologi Manusia dan Mekanisme Penyakit III*. Penerbit Buku Kedokteran EGC. Jakarta. 1997.
13. Ganong, W.F. *Buku Ajar Fisiologi Kedokteran, Edisi ke-7*. EGC. Jakarta. 2003.
14. DePass, L.R., Garman, R.H., Woodside, M.D., Giddens, W.E., Maronpot, R.R., and Weil, C. S. Chronic Toxicity and Oncogenicity Studies of Ethylene Glycol in Rats and Mice. *Fundamental Applied Toxicology*. 1986. **7**(4): 547-65.
15. Cruzan, G., Corley, R.A., Hard, G.C., Mertens, J.J.W.M., McMartin, K.E., Snellings, W.M., Gingell, R., and Deyo, J.A. Subchronic Toxicity of Ethylene Glycol in Wistar and F-344 Rats Related to Metabolism and Clearance of Metabolites. *Toxicological Sciences*. 2004. **81**: 502-511.
16. Doenges, M.E. *Rencana Asuhan Keperawatan Untuk Perencanaan dan Pendokumentasian Perawatan Pasien Edisi ke 3*. EGC. Jakarta. 1999.
17. Stockhom, S.L. and Scot, M.A. *Fundamental of Veterinary Clinical Pathology*. Iowa State Press. 2002.
18. Susilawati, H.L., Shanty L., dan Sutarno. Analisis Kimia-Fisik Urin Tikus Putih (*Rattus norvegicus*) setelah Pemberian Ekstrak Daun Seledri (*Apiumgraveolens* Linn.). *Jurnal Bio SMART*. 2009. Vol 5, 43-46.
19. Becker, G. Uric acid stones. *Nephrology*. 2007. **12**: S21-S23.
20. Hidayati, A. M., Yusrin dan Herlisa, A. Pengaruh Frekuensi Penggunaan Teh Daun Tempuyung Kering (*Sonchusarvensis*) Terhadap Daya Larut Kalsium Oksalat (CaC₂O₄). *Jurnal Kesehatan*. 2009. Volume 2 Nomor. 2.
21. Suharjo, J.B dan Cahyono. *Batu Ginjal*. Kanisius. Yogyakarta. N27, 2003. 30-31, 48-49, 82.
22. Yilmaz, H., Giizel, Y., Onal, Z., Altiparmak, G., danKocakaya, S.O. *4D-QSAR Study of p56 Protein Tyrosine Kinase Inhibitory Activity of Flavonoid Derivates Using MCET Method*. Korean Chemical. 2011. **32**(12): 4352-4360.
23. Abbas, A.K., and Lichtman, A.H. *Basic Immunology: Functions and Disorders of the Immune System*, 2nd Edition. Saunders. Philadelphia. 2004. 27, 34-37, 44, 108, 114-116.
24. Dunder, M., Kocak, I., Yenisey, C., Serter, M., danOzeren, B. *Urmary and Serum Cytokine Levels in Patients Undergoing SWL*. Brazilian Journal of Urology. 2001. 495-499.
25. Sharma, A., S. Bansal, dan R.K. Nagpal. Lipid Peroxidation in Bronchial Asthma. *Indian Journal of Pediatrics*. 2003. **70**(9): 715-717.
26. Chung, H.Y., T. Yokozawa., D.Y. Soung., I.S Kye and B.S. Baek. *Peroxyntirite-Scavenging Activity Of Green Tea Tannin*. J Agric. Food Chem. 1998. **46**: 4484-4486.
27. Nelson, D.L. and M.M. Cox. *Lehninger Principles of Biochemistry (4th ed.)*. Worth Publisher. New York. 2008.
28. Sumardika, I.W. dan I.M. Jawi. Ekstrak Air Daun Ubi Jalar Ungu Memperbaiki Profil Lipid dan Meningkatkan Kadar SOD Darah Tikus Yang Diberi Makanan Tinggi Kolesterol. *Medicina*. 2012. **43**: 67-71.
29. Irawan, M, A. CairanTubuh, Elektrolit & Mineral. *Sports Science Brief*. 2007. **01**: 1.



Institute of Tropical
Disease
Universitas Airlangga

in a collaboration
with



Institute for Protein Research
Osaka University

Proceeding

Molecular and Cellular Life Sciences:
Infectious Diseases, Biochemistry and
Structural Biology
MCLS 2015

ISBN 978-602-14292-4-2

Pathogenicity and Molecular Studies of Zoonotic Disease Caused *Edwardsiella tarda*

Kurniasih^{a*}, Siti Narwiyani^b

¹⁷¹
^aPathology Department, Faculty of Veterinary Medicine, Gadjah Mada University, Yogyakarta, Indonesia
^bBKIPM, Sultan Hasanuddin, Makassar, Indonesia

32

Abstract

The aim of study was to determine a) pathogenicity of *Edwardsiella tarda* isolates from different regions and type of fish, b) genetic variation of *Edwardsiella tarda* based on molecular study. Isolates of *Edwardsiella tarda* were taken from Tilapia (Yogyakarta), catfish (Semarang), imported Tortoise (Brazil), goldfish (Pontianak). All isolates were extracted, amplified in the SSU rRNA-16S and sequenced for phylogenetic tree. Redness lesions began to appear on the second day post infection. Three isolates of *Edwardsiella tarda* from Pontianak, Jambi, Yogyakarta was same strain originating from fish, where as the isolates from turtle was same strain as isolates from human origin.

Keywords: Phylogenetic tree; *Edwardsiella tarda*; Tilapia

1. Introduction

Edwardsiella tarda caused *Edwardsiellosis/Emphiseomatous Putrefactive Disease of Catfish* (EPDC) or *Edwardsiella Septicaemia* (ES). *Edwardsiellosis* was a primer disease at catfish aquaculture in America and transmitted to Europe, Japan, Taiwan, Thailand, Singapore, and Malaysia⁷. In Indonesia, *Edwardsiellosis* has been reported from island of Java, Sumatra and Kalimantan.

Edwardsiella tarda was a bacterium enteric type, could be transmitted horizontally among fish and could become a carrier in the water and mud⁹. *E. tarda* could be alive in freshwater and marine, spread to reptiles, frog, lobster, pig, and human. Mortality in *channel catfish* was low (5%), however, it could increase to 50% since they were moved to agriculture¹⁰.

Edwardsiella tarda was isolated 75% from samples water pool of catfish, 64% from samples mud pool of catfish and 100% from frog, turtles and crayfish from crayfish's pool. This condition showed that *E. tarda* was a microflora at catfish's pool and the present of this bacteria makes the potential of fish disease still there³.

Edwardsiellosis can be diagnosed with someway: 1) Isolation and identification causative agent *E. tarda*³ 2). Immune reaction with ELISA 3). Immunohistochemistry on infected organs⁶ and 4). Molecular with PCR methods².

Edwardsiella tarda was isolated from *Tilapia* fish and infected water by PCR with hemolysin gene application. Samples from liver and intestine of fish showed clearly band beside infected water². Detection of *E. tarda* in oyster road fish directly by using PCR provide an accurate and fast results using a comparator *E. ictaluri* and *Vibrio* sp. as a negative control¹.

E. tarda infections in humans are generally transmitted through fecal contamination of human, food and water contaminated with these bacteria called fecal-oral transmission. *E. tarda* strain on the fish obtained transmission process only between fish⁵.

* Corresponding author. Tel.: -
E-mail address: kurniasih_1951@yahoo.co.id

2. Methods

Edwardsiella tarda have been isolated and identified from carp (Pontianak), tilapia (Yogyakarta), catfish (Semarang), turtles (Brazil) and the ATCC isolates from Singapore. All isolates carried revirulence prior to treatment. Revirulence done by infecting carp intraperitoneally with 0.1 cc of each isolate *E. tarda* were 107 cells/ml. All goldfish autopsied, reisolated and reidentified against *E. tarda*.

Molecular test to isolate performed by PCR method which consists of the extraction of DNA with Qiagen kit and 16S rRNA amplification. Primers used are: Forward Eta 2-351 (5'-TAG TGT AGG GAA GGA GGA-3'). Reverse Edwsp-780r (TAG 5'CTC CTT CTT AGT GCC-3 ') and from human Eta 1-363 F (5'-GTG TCC GCA GTG TTA ATA-3'). Reaction amplification using Intron Kit and running on condition predenaturation 94°C for 2 minutes, denaturation at a temperature of 94°C for 1 minute, annealing at a temperature of 51°C for 1 minute, extension at a temperature of 72°C for 30 seconds and post-extension at a temperature of 72°C for 5 minutes, with amplification reactions are run as many as 26 cycles¹. Electrophoresed amplification product by means of PCR products of 8 ml was added 2 ml of loading dye is checked by 1.5% agarose gel at 100 V for 30-45 minutes. Amplification results showed good bands and sharply by 50 ml done sequencing DNA purification and Biotechnology Laboratory, PT. Wilmar, Cikarang, West Java. Sequencing results of 16S rRNA in the area of statistical analysis from multiple sequence alignment program Clustal W version 1.8 and proceed with the neighbor-joining method and maximum parsimony method to get the highest yield phylogenetic tree⁸.

3. Results and discussion

Results of the isolation and identification of bacteria showed that four isolates are the same as the results *Edwardsiella tarda* ATCC. Results identify the characteristics shown in Table 1.

Table 1. Results of identification characteristics of five isolates *Edwardsiella tarda*

Media	ATCC	Pontianak Carp	Semarang Catfish	Jogja Tilapia	Brazilia turtles
Gram test	-	-	-	-	-
Oxidase	+	+	+	+	+
Catalase	+	+	+	+	+
Motility	+	+	+	+	+
Indole	+	+	+	+	+
H ₂ Sin TSIA	+	+	+	+	+
Voges-proskover	+	+	+	+	+
Urea hydrolysis	-	-	-	-	-
Lysine decarboxylase	+	+	+	+	+
Ornithine decarboxylase	-	-	-	-	-
Gelatin hydrolysis	+	+	+	+	+
Gas of glucose	+	+	+	+	+
Acid of Glucose	+	+	+	+	+
Acid of Lactose	+	+	+	+	+
Acid of Sucrose S	+	+	+	+	+

Result rRNA sequencing of five isolates of *E. tarda* in small areas subunit (SSU) 16S looked for variations in genotype (Fig. 1).

```

#ETD      GTA TAT --A TTT ATC TTT TGT TTT CTC TTT [ 30]
#KK       ACT TAC CGA AAA AAC ACC GGG CTA CTC CGT [ 30]
#LL       AAT AAT AAA AAA AAA AAA GAA CGC AAG AGG [ 30]
#E2       ACC TAC AGA AGA AGC ACC GGC TAA CTC CGT [ 30]
#ETP      ACC TAC AGA AGA AGC ACC GGC TAA CTC CGT [ 30]
#Edwardsiella_tarda ACC TAC AGA AGA AGC ACC GGC TAA CTC CGT [ 30]

#ETD      TTT TTC TCC GAT CTT CCC TCT GGA TGC GTC [ 60]
#KK       GCC AGC AGC CGC GGT AAT ACG GAG GGT GCA [ 60]
#LL       CAG AGG AGG GGA TAA AAT AAG AAG AAC GTA [ 60]
#E2       GCC AGC AGC CGC GGT AAT ACG GAG GGT GCA [ 60]
#ETP      GCC AGC AGC CGC GGT AAT ACG GAG GGT GCA [ 60]
#Edwardsiella_tarda GCC AGC AGC CGC GGT AAT ACG GAG GGT GCA [ 60]

#ETD      CCA GTT AA- GCT GGT GTT CTT T-- --C AAT [ 90]
#KK       AGC GTT A-- ATC TGA ATT ACT GGG CGT AAA [ 90]
#LL       TAA GAA AAT AAC CAC AGC AAA CAA AAG AAA [ 90]
#E2       AGC GTT AT- ATC GGA ATT ACT GGG CGT AAA [ 90]
#ETP      AGC GTT A-- ATC GGA ATT ACT GGG CGT AAA [ 90]
#Edwardsiella_tarda AGC GTT A-- ATC GGA ATT ACT GGG CGT AAA [ 90]

#ETD      TTA CCA ATC GCT GCT GTC TTA CTC CCT TAA [120]
#KK       GCG CAC GCA GGC GGT TTG TTA ATA ATT GGA [120]
#LL       ATT TTT ATT TCT TTC CCT TTA CGC CCC CAA [120]
#E2       GCG CAC GCA GGC GGT TTG TTA A-- GTT GGA [120]
#ETP      GCG CAC GCA GGC GGT TTG TTA A-- GTT GGA [120]
#Edwardsiella_tarda GCG CAC GCA GGC GGT TTG TTA A-- GTT GGA [120]

#ETD      TTC GTA AAT --G CTG CTC CTC CTA TGG CCT [180]
#KK       TGT GAA ATC --C CCG GGC TTA ACC TGG GAA [180]
#LL       ACA ACA ACT TAC CCA AAA CTC ATT TTA TTA [180]
#E2       TGT GAA ATC --C CCG GGC TTA ACC TGG GAA [180]
#ETP      TGT GAA ATC --C CCG GGC TTA ACC TGG GAA [180]
#Edwardsiella_tarda TGT GAA ATC --C CCG GGC TTA ACC TGG GAA [180]

#ETD      GGT GTT GCT AGT ATT TGC AGG TGT TAC [177]
#KK       CTG GAT CCA AGA CTG G-C AAG CTA CAG [177]
#LL       AAA TTT ACG AAA TCG CAC AAC AGT ACA [177]
#E2       CTG CAT CCA AGA CTG GGC AAG CTA CAG [177]
#ETP      CTG CAT CCA AGA CTG GGC AAG CTA CAG [177]
#Edwardsiella_tarda CTG CAT CCA AGA CTG G-C AAG CTA GAG [177]

```

Fig. 1. The sequence results rRNA sequencing 5 isolates of *E. tarda* on 16S SSU area.

Maximum parsimony analysis results indicate that the 3 isolates *E. tarda* of Pontianak, Yogyakarta, Jambi one cluster with *E. tarda* derived from Genbank with a validity of 99%. *E. tarda* isolates of turtles Brazil one cluster with isolates ATCC with the number of validity 93% (Fig. 2).



Fig. 2. Result of analysis with maximum parsimony bootstrap 1000x resampling of rRNA sequencing results at 5 isolates *E. tarda* 16S area.

Neighbor-joining analysis results showed that three isolates of *E. tarda* from Pontianak, Yogyakarta, Jambi very closely related to *E. tarda* derived from GenBank with validity of 99%. While *E. tarda* isolates of turtles Brazil a relative with ATCC isolate the validity figure of 95% (Fig. 3).

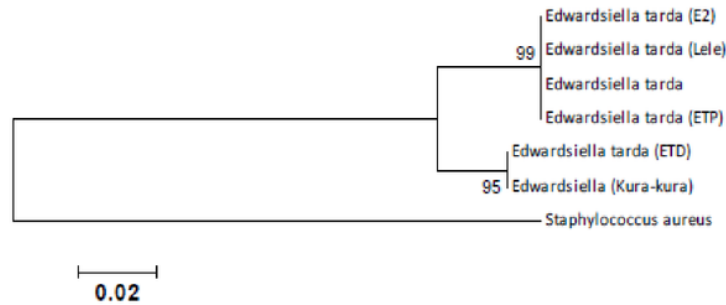

Fig. 3. Result of neighbor-joining analysis of the result of rRNA sequencing 5 isolates *E. tarda* on the area 16S.

Isolates from turtles allegedly obtained from human feces. *Edwardsiellosis* can infect humans that cause hemorrhagic enteritis, disease transmission can occur from pregnant mothers to babies born to infected humans or *Edwardsiella tarda* when performing activities in contaminated waters⁴. *Edwardsiellosis* in humans generally show very serious consequences such as hemorrhagic enteritis, inflammation of the kidneys compared *Edwardsiellosis* in fish⁵. This is consistent with the phylogenetic tree obtained shows isolates of turtles are in a cluster with isolates from humans (ATCC).

The second method is to analyze *Edwardsiella tarda* maximum parsimony and neighbor-joining showed similar results, among others, the formation of two clusters are clusters of fish coming from Pontianak, Yogyakarta and Semarang are in one cluster, while isolates turtles are a cluster with ATCC isolates from humans.

Conclusion

Three isolates of *E. tarda* is the same strain derived from fish compared to isolates of *E. tarda* of turtles Brazil and ATCC isolates derived from human phylogenetic tree.

References

- Baird, K.D., Chikarmane, H.M., Smolowitz, R., and Uhlinger, K.R. J. Biological Laboratory. 2003. **205**: 235-236.
- Chen, J.D. & S.Y. Lai. Molecular Identification of *Edwardsiella tarda*. *Zool. Stud.*, 1998. **37**: 169 – 176.
- Inglis, V., Robert, R.J., dan Bromage, N.R. *Bacterial Disease Of Fish*. Blackwell Scientific Publication. Oxford, 1993. Hal. : 61-75
- Mowbray, E.E., Buck, G., Humbaugh, K. E. and Marshall, G.S. Maternal Colonization and Neonatal Sepsis Caused by *Edwardsiella tarda*. *Pediatric*. 2003. **111**: 296-298.
- Nucci, C., Silveira, W.D., Correa, S. S., Nakazato, G., Bando, S.Y., Ribeiro, M.A., dan Castro, A.F.P. Microbiological Comparative Study of Isolates of *Edwardsiella tarda* Isolated in Different Countries from Fish and Human. *Veterinary Microbiology*. 2002. **89**: 29-39.
- Pirarat, N., Katagiri, T., Maita, M., Endo, M., dan Sailasuta, A. Distribution of *Edwardsiella tarda* Antigens and IgM Containing Cells in Tilapia Immune Organs during Septicemia: An Immunohistochemical Study. *The Thai Journal of Veterinary Medicine*, 2008. **38**: 45-52.
- Post, George. *Textbook of Fish Health*. T.F.H. Publications Inc. 1987. Hal. 31-37.
- Saitou, N & Nei, M. The neighbour-joining method: a new method for reconstructing phylogenetic trees. *Molecular Biology and Evolution*, 1987. **4**: 406 – 425.
- Wakabayashi, H. and Egusa, S. *Edwardsiella tarda* (*Paracolobactrum anguillimortiferum*) associated with pond-cultured eel diseases. *Bulletin of the Japanese Society of Scientific Fisheries*, 1973. **39** : 931-936
- Wyatt, L.E., Nickelson, R.H., II dan Vanderzant, C. *Edwardsiella tarda* In Freshwater Catfish. 1979.



Institute of Tropical
Disease
Universitas Airlangga

in a collaboration
with



Institute for Protein Research
Osaka University

Proceeding

Molecular and Cellular Life Sciences:
Infectious Diseases, Biochemistry and
Structural Biology
MCLS 2015

ISBN 978-602-14292-4-2

Biological Toxicity and Identification of Extract of n-Hexane, Chloroform, Ethyl Acetate and Ethanol from *Chlorella pyrenoidosa* Against Larvae of *Artemia salina*

Ni Wayan Sri Agustini* and Kusmiati

131

Research Center for Biotechnology-LIPI, Jl. Raya Bogor Km. 46, Cibinong, Bogor 16911 Indonesia

Abstract

Research on the identification and biological toxicity of some extracts from microalgae *Chlorella pyrenoidosa* had carried out. The biomass of microalgae *Chlorella pyrenoidosa* was extracted using n-hexane, chloroform, ethyl acetate, and ethanol by way of soxhletation. Toxicity of biological using Brine Shrimp Letalyti Test against *Artemia salina* Leach. Results showed that extract of ethyl acetate, n-hexane, chloroform and ethanol of *Chlorella pyrenoidosa* had been potentially toxic against *Artemia salina* Leach with value of LC₅₀ respectively 10.256 µg/ml, 30.130 µg/ml, 80.723 µg/ml, and 129.717 µg/ml. Ethyl acetate extract of *Chlorella pyrenoidosa* potential as raw material for anti-tumor or cancer because it has an LC₅₀ value by category of highly toxic and compounds contained in the ethyl acetate extract is Eucalyptol, Trans-caryophyllene, and limonene.

Keywords: Toxicity; identification; n-hexana; chloroform; ethyl acetate; ethanol; *C. pyrenoidosa*; *A. salina* L.

425

* Corresponding author. Tel.: (021) 8754587; fax: (021)8754588
E-mail address: wayan_sa2002@yahoo.com

1. Introduction

Chlorella is one type of Chlorophyceae that contain bioactive compounds that nourish the protein content of about 60% dry weight¹. In addition, Chlorella also contains unsaturated fatty acids such as Eicosapentaenoic Acid (EPA) and Docosahexaenoic Acid (DHA), saturated fatty acids, amino acids, nucleic acids, enzymes, carotenoids, chlorophyll a and chlorophyll b². Therefore, Chlorella can be developed as food, industrial raw materials, cosmetics, pharmaceutical and health. *Chlorella pyrenoidosa* is one type of microalgae potential as anticancer, antitumor, improve the immune system, and antibacterial. Chlorella also contains beta-carotene which is believed to boost the immune system and anti-cholesterol, efficaciously prevent the calcification of blood vessel walls and as an antioxidant³. One of the method of extraction to obtain bioactive compounds of *C. pyrenoidosa* is soxhletation. The principle of filtering the soxhletation is repeated in order to obtain perfect results, and the solvent used is relatively less. Extraction was done using organic solvents with different polarity level.

The first extracted using n-hexane and then chloroform which aims to attract non-polar compounds such as terpenoids and lipids. After that, followed by ethyl acetate and ethanol which aims to separate the compound which is more polar compounds, such as proteins, xanthon, flavonoid and polyphenols. However, it often does not produce a perfect separation of compounds-compounds extracted. Biological toxicity test is one method used to determine the level of toxicity of a substance with the help of test animals. Animal testing is *Artemia salina* leach. *Artemia salina* Leach used because it has a thin skin and sensitive to the environment, so that substances can easily enter the body by diffusion so that *Artemia* will die if these substances are toxic, life faster, easier bred and the price is cheap. Principles of bioactive component toxicity test is always toxic if given in high doses and into drugs at low doses. One method of biological toxicity testing is BSLT (Brine Shrimp Lethality Test), which is a test and a screening to determine whether a compound has activity biology and pharmacological with significant the level of trust 95%⁴.

The toxicity of the extract caused by the compounds contained in these materials. Therefore, the identification of compounds by GC-MS (Gas Chromatography-Mass Spectrometer). This method has high sensitivity, so as to separate the various compounds are mixed with each other and are able to analyze various compounds although the level / low concentrations⁵. Based on the above, then this research aimed to determine the biological activity of some extracts of biomass *Chlorella pyrenoidosa* against *Artemia salina* Leach and identification of compounds by using GC-MS.

2. Methods

2.1. Cultivation of Microalgae *Chlorella pyrenoidosa*

Chlorella pyrenoidosa cultivated in medium commercial technique consisting of trisodium phosphate (0.3 g/L), ammonium sulfate (0.8 g/L), Gandasil-D (1 g/L) and urea (1 g/L). Cultivation is done on a 1 liter bottle with a light intensity of 2500 lux. Aeration flowed continuously and pH 7. Growth of microalgae using the spectrophotometric method of turbidimetry at a wavelength of 680 nm.

2.2. Extraction of Biomass from *Chlorella pyrenoidosa*

25 g of dry biomass *C. pyrenoidosa* was extracted with soxhletation method using successive solvent is n-hexane, chloroform, ethyl acetate and ethanol. Extract obtained and evaporated using an evaporator until thick, then dried using waterbath at 50°C.

2.3. Identification of Compounds by Gas Chromatography-Mass Spectrometer (GC-MS)

Type of GC-MS ie Agilent Technologies 5973 N₃ Gas Chromatograph with Auto Sampler and 5873 chemstation Mass Selective Detector and a data system. Capillary column (innowax), Length: 60 m Width: 0.25 mm, film thickness 0.25 mm, temperature of injector: 2900C, Temperature of detector: 2900C, temperature of program: 900C (150/min)-2900C (20 min), carrier gas: Helium 1 ml/min, Constant Flow injection Volume: 1 mL split (ratio 50: 1).

2.4. Toxicity tests with the BSLT (Brine Shrimp Letality Test)

20 mg egg of *Artemia salina* Leach hatched in a container that has been of water sea/synthetic sea water and irradiated with fluorescent lamp. After 24 hours, nauplii were transferred to other places, and 24 hours later the nauplii can be used as test animals. The concentration of the test solution used was 1000, 100 and 10 ppm. Concentration is made with three replications, then into each vial entered 3 mL of seawater and 10 tails nauplii and add sea water to 5 ml. Observations were made after 24 hours by counting the number of dead and life

larvae. Measurement of mortality (%) larvae of *Artemia salina* is calculated with the following formula: accumulation of dead divided by the accumulation of life plus the accumulation of dead multiplied by 100%.

LC₅₀ is the concentration of the test solution which can cause death in 50% of experimental animals. Calculating of LC₅₀ using regression equation ($Y = a + bX$) with log D as the x-axis and y-axis as persen of mortality. An active or toxic substance expressed when the LC₅₀ value <1000 mg/ml.

3. Result and discussion

3.1. Extraction biomass dry *Chlorella pyrenoidosa* with n-hexane, chloroform, ethyl acetate and ethanol with soxhletation.

According Voight (1994), the process of withdrawal of material (extraction) occurs by the flow of solvent into the fuel cell which causes the protoplasm swell, and the cell content in the material to be dissolved according to solubility. High dissolving power associated with the polar solvent and polar materials are extracted⁶.

The initial step of this study is to perform the extraction of the biomass *Chlorella pyrenoidosa* using successive solvent ie n-hexane, chloroform, ethyl acetate and ethanol. The use of some types of solvents aims to attract non-polar organic compounds of up to polar. Extraction is done by soxhlation, because the sample can extracted with perfect and it is done repeatedly, amount of solvent which is used less, rapid, number of samples required a little and, organic solvents can take organic compounds repeatedly.

Extracts produced from 20 g of dry biomass of *C. pyrenoidosa* was 0.83 g of n-hexane extract, chloroform extract 2.90 g, 3.25 g ethyl acetate extract and extract of 5.15 g ethanol. The highest extract obtained from ethanol, because ethanol is a universal solvent that can dissolve many compounds. While the smallest dry extract produced by the n-hexane is a mixture of volatile liquid hydrocarbons (Table 1).

Table 1. The results of the extraction of biomass from *Chlorella pyrenoidosa*

No	Solvents	Weight of Extract (g)
1	n-Hexane	0.83
2	Chloroform	2.90
3	Ethyl Acetate	3.25
4	Ethanol	5.15

3.2. Identification extract of *Chlorella pyrenoidosa* has potential toxicity using GC-MS (Gas Chromatography-Mass Spectrometer).

According to analysis by GC-MS, compounds having a percent quality/similarity more than 90 on the n-hexane extracts are compounds of fatty acids is 44.07%, n-hexane is a non-polar solvent that can only attract non polar compounds. While the smallest fatty acid compounds produced by ethanol amounted to 4.92%. The highest terpenoids compounds produced on the ethyl acetate extract are 93.4% while the lowest is produced by extract of n-hexane are 2.02%. The largest alkane compounds is produced by chloroform in the amount of 2.98% while the lowest alkane compounds is produced by n-hexane of 2.51%. Largest alkene compounds is produced by n-hexane that is equal to 7.69%, while the lowest alkene compounds is produced by chloroform of 3.52%. While the phenolic compounds found only in n-hexane of 0.20% (Table 2).

Alkanes are saturated aliphatic hydrocarbon compound which binds all single carbon chain. Usefulness of alkanes: for example methane as fuel for cooking, and carbon black (ink, paint, polish, tires). While, alkenes are unsaturated hydrocarbons in the carbon chain are double bonds. Usefulness of alkenes such as ethene: used as a raw material for making plastic polythene (PE). Propene: used to make plastics, synthetic rubber. Can be used as an anesthetic (mixed with O₂).

Table 2. Results of gc-ms analysis of extract n-hexane, chloroform, ethyl acetate and ethanol from *Chlorella pyrenoidosa*

Compounds	BM	Molecule formula	Extract							
			n-hexana		Chloroform		Ethyl Acetate		Ethanol	
			RT	Area %	RT	Area %	RT	Area %	RT	Area %
Fatty acids										
Isopropyl myristate	270.45	C ₁₇ H ₃₄ O ₂	16.25	7.47	-	-	-	-	-	-
Hexadecanoic acid	256.42	C ₁₆ H ₃₂ O ₂	17.05	4.39	17.06	4.99	-	-	17.36	4.92
Octadecenoic acid	284.48	C ₁₈ H ₃₄ O ₂	18.70	1.38	-	-	-	-	-	-
9-octadecenoic acid	282.46	C ₁₈ H ₃₄ O ₂	18.54	4.16	18.54	4.82	-	-	-	-
9,12-Octadecadien acid	280.44	C ₁₈ H ₃₂ O ₂	18.90	2.48	-	-	-	-	-	-
9,12,15-Octadecatrien Di-(2-ethylhexyl) Phthalate	278.43	C ₁₈ H ₃₀ O ₂	18.96	4.48	-	-	-	-	-	-
	390.55	C ₂₄ H ₃₈ O ₄	24.06	19.71	-	-	-	-	-	-
Contents			44.07%		9.81%		-		4.92%	
Terpenoid										
Azulene	128.17	C ₁₀ H ₈	11.22	0.29	11.18	1.68	-	-	-	-
Eucalyptol	154.249	C ₁₀ H ₁₈ O	-	-	-	-	3.52	86.47	-	-
Limonene	136.24	C ₁₀ H ₁₆	-	-	-	-	5.11	2.84	-	-
Trans-aryophyllene	204.36	C ₁₄ H ₂₄	-	-	-	-	7.02	4.09	-	-
Neophytadiene	278	C ₂₀ H ₃₈	16.41	1.73	16.42	13.75	-	-	16.76	3.81
Contents			2.02%		15.43%		93.4%		3.81%	
Alkana										
Pentadecane	305.33	C ₁₅ H ₃₂	13.70	0.17	13.71	0.56	-	-	-	-
Hexadecane	226.44	C ₁₆ H ₃₄	14.52	0.43	-	-	-	-	-	-
Heptadecane	240.46	C ₁₇ H ₃₆	15.30	0.46	-	-	-	-	-	-
Octadecane	254.49	C ₁₈ H ₃₈	16.06	1.02	13.71	0.56	-	-	-	-
Tetradecane	198.39	C ₁₄ H ₃₀	-	-	12.83	0.46	-	-	-	-
Eicosane	282.55	C ₂₀ H ₄₂	14.52	0.43	14.53	1.40	-	-	-	-
Contents			2.51%		2.98%		-		-	
Alkena										
Hexadecene	224.43	C ₁₆ H ₃₂	14.47	0.26	-	-	-	-	-	-
Octadecene	252.48	C ₁₈ H ₃₆	16.02	1.09	-	-	-	-	-	-
Nonadecene	266.50	C ₁₉ H ₃₈	21.48	1.97	17.58	3.52	-	-	-	-
Eicosene	280.53	C ₂₀ H ₄₀	17.57	4.37	-	-	-	-	-	-
Contents			7.69%		3.52%		-		-	
Phenol										
Phenol,2,4-bis (1,1-dimethylethyl)	588.95	C ₁₄ H ₂₂ O	13.95	0.20	-	-	-	-	-	-
Contents			1.93%		-		-		-	

3.3. Toxicity test of extract n-hexane, chloroform, ethyl acetate and ethanol from *Chlorella pyrenoidosa* with bslt (Brine Shrimp Lethality Test)

BSLT method using larval shrimp *Artemia salina* Leach as test animals is one method which is widely used for the search of new anticancer compounds derived from plants or microorganisms such as microalgae. The results of toxicity tests with this method has been shown to have a correlation with power cytotoxic anticancer compounds. In addition, this method is also easy to do, inexpensive, fast and accurate enough⁴.

Otherwise extract has the ability or biological activity when generating high mortality based on its LC₅₀ value. Meaning LC₅₀ is the concentration of how the extract can be lethal to 50% of the test organisms, such as the larvae of *Artemia salina* (brine shrimp). The smaller the value of the LC₅₀, the greater the ability of its toxicity. An extract is considered highly toxic when the LC₅₀ value of below 30 ppm, is considered toxic if it has a value of 30-1000 ppm LC₅₀ and considered not toxic if LC₅₀ values above 1000 ppm. The toxicity level to give meaning to its activity as a potential anticancer drug. The smaller value of LC₅₀, the compounds are more toxic and more potential as an anticancer compound⁴.

In Table 1 is the result of the percentage of mortality of *A. salina* L. against extract of n-hexane, chloroform, ethyl acetate, and ethanol from *Chlorella pyrenoidosa* with BSLT method. Based on these results, will be obtained molarity percentage and for calculating of LC₅₀ of each extract used the calculations of probit analysis

using SPSS 13 for calculating the LC₅₀ of each extract were tested. LC₅₀ results can be seen in Table 3.

Table 3. Test calculations result of BSLT extract n-hexane, chloroform, ethyl acetate and ethanol from *Chlorella pyrenoidosa*

Samples	Dose (ppm)	Log D (x)	Dead	Life	Accumulated dead	Accumulated life	% mortality (y)	LC ₅₀ ppm
Ethyl Acetate	1000	3	27	3	68	3	95.774	10.256
	100	2	23	7	41	10	80.392	
	10	1	18	12	18	19	48.648	
n-hexane	1000	3	22	8	56	8	87.5	30.130
	100	2	18	12	34	20	62.962	
	10	1	16	14	16	26	38.095	
Chloroform	1000	3	24	6	48	6	88.888	80.723
	100	2	15	15	24	21	53.333	
	10	1	9	21	9	42	17.647	
Ethanol	1000	3	10	20	42	20	67.741	129.717
	100	2	9	21	32	41	43.835	
	10	1	23	7	23	48	32.394	

In Table 3 shown extracts of n-hexane at a concentration of 10 ppm resulted in percentase of mortality ie 38.095%, a concentration of 100 ppm resulted in percentase of mortality ie 62.962%, and a concentration of 1000 ppm resulted in percentase of mortality ie 87.5%, so that value of LC₅₀ of n-hexane extract is 30.130 ppm, therefore that the n-hexane extracts are included in the category of toxic.

The percentage of mortality of larvae *Artemia salina* on extract of chloroform with concentrations of 10 ppm is 17.647%, at a concentration of 100 ppm is 53.333%, and a concentration of 1000 ppm is 88.888%. LC₅₀ value of chloroform extract is 80.723 ppm, so the chloroform extracts are included in the category of toxic.

At the ethyl acetate extract, showing the percentage of mortality of larvae *Artemia salina* respectively 10 ppm is 48.648%, a concentration of 100 ppm is 80.392%, and a concentration of 1000 ppm is 95.774%. LC₅₀ values of ethyl acetate extract of 10.256 ppm, based on the value of LC₅₀ ethyl acetate extracts are included the category of highly toxic because it is below 30 ppm.

Further, the percentage of mortality in the ethanol extract in a row on the extract concentration 10 ug/ml namely 32.394%, a concentration of 100 ppm is 43.835%, and a concentration of 1000 ppm is 67.741%. LC₅₀ value of the ethanol extract is 129.717 ppm, so the ethanol extract was included in the category of toxic. Base on the result, showing that the greater the dose of the extract concentration, the mortality of larvae *Artemia salina* is also getting bigger. This is in accordance with Harbone (1978), that the higher the concentration of the extract, the toxic also higher. Mortality of the extract caused by the toxic properties of the compounds contained in the extract⁵. Results of control with seawater (mortality 0%), it indicates that larvae that die due to toxic compounds in the extract, not because of other factors.

Meyer *et al.* (1982) explained that the activities of the toxicity of an extract in BSLT if the extract can cause the death of 50% of larvae at a concentration of less than 1000 ppm⁴. The most toxic extracts can be seen from the ability to cause the death of test animals larger with increasingly smaller concentrations. This shows that the most toxic extract is an extract of ethyl acetate with 10.256 ppm value, followed by n-hexane extract is 30,130 ppm, then the chloroform extracts namely 80.27 ppm and ethanol extract is 129.717 ppm.

Molarity percentage of *A. salina* in ethyl acetate extract showed more toxic LC₅₀ value (10.256 ppm) due semipolar compounds dissolved in ethyl acetate extract having a smaller size so that the extract easier penetration into the cell membrane through the process of diffusion in the tails (tail) *A. salina* which has hydrophobic properties on a phospholipid bilayer. This causes to more rapid cell damage, so the cell will die. Besides, it is also because of the class of terpenoid compounds in the ethyl acetate extract were very large compared with other compounds, namely 93.4%, consisting of eucalyptol, limonene and trans-caryophyllene. This is according to research Indrayani *et al.* (2006), which suggests that the terpenoid compounds contained in extracts of leaves *Stachyterpheta jamaicensis* L. Vahl are toxic to larvae of *Artemia salina* Leach and have anticancer activity⁷. Several studies report stated that eucalyptol has been used to treat rhinitis bronchitis, chronic sinusitis, and also for the treatment of asthma, anti-inflammatory, inhibits tumor production⁸. Research in vivo (bioassays) shows limonene inhibits the growth of liver cancer, lung adenomas, and gastric tumors⁹. Tans-caryophyllene has been used for anti-inflammatory, antioxidant, antibiotic, local anesthetic activity and anti-cancer¹⁰.

4. Conclusions

Extract ethyl acetate, n-hexane, chloroform and ethanol from *Chlorella pyrenoidosa* has toxic properties because the LC₅₀ value is less than 1000 ppm. The ethyl acetate extract of *Chlorella pyrenoidosa* potential as anticancer because it has a LC₅₀ value less than 30 ppm is equal to 10.256 ppm. Results of identification of compounds of extract of Ethyl acetate from *Chlorella pyrenoidosa* is Eucalyptol, Trans-caryophyllene, and limonene.

References

1. Kabinawa, I. N. K., Prana, S. M. I., Sukara, E. dan Soetisna, U., Kultur Mikroalga: Aspek dan Prospek. Prosiding Seminar Nasional Bioteknologi Mikroalga. Puslitbang-Biotek. LIPI, Bogor, 1993, hal 21-33.
2. Sharma, O. P., Text Book of Algae. Departemen of Botany Meerot Collage. McGraw – Hill Publishing Company Limited. New Delhi. 1986, p. 158-162.
3. Kusmiati, Agustini, N. W. S., Swasono, R., Tamat., Irawati, M., Ekstraksi dan Purifikasi Senyawa Lutein dari Mikroalga *Chlorella pyrenoidosa* Galur Lokal INK, Jurnal Oseanografi, Pusat Penelitian Bioteknologi-LIPI, Cibinong. Bogor, 2010, vol. 5, p. 1.
4. Meyer, B. N., et al., *Brine Shrimp*, A Convenien General Bioassay for Active Plant Conctituens, Planta Medica, 1982, vol 45, p. 31-34.
5. Harborne, J. B., Metode Fitokimia, Penuntun Cara Modern Menganalisa Tumbuhan. Edisi II. Diterjemahkan oleh Padma, W. K., Soediro I., ITB, Bandung, 1978, p. 3-15.
6. Voight, R. Buku Pelajaran Teknologi Farmasi. Penerjemah Soendani, N.S.Gajah mada University. 1994.
7. Indrayani, L., Hartati, S., dan Lydia, S., Skrining Fitokimia dan Uji Toksisitas Ekstrak Daun Pecut Kuda (*Stachyterpetha Jamaicensis* L. Vahl) Terhadap Larva Udang Artemia Salina Leach. Jumal Kimia, Universitas Airlangga, 2006, vol 2, p. 57-61.
8. Soares, M.C.M.S., Damiani, C.E.N., Moreira C.M., Stefanon, I., Vassallo, D.V., Eucalyptol, An Essential Oil, Reduces Contractile Activity In Rat Cardiac Muscle, Brazilian Journal of Medical and Biological Research, 2005, vol 87, p. 453-461.
9. Sun, J., D-limonene Safety and Clinical Applications, Altemative Medicine Review, 2007, vol 12, p 3.
10. Legault, J., Pichette, A., Potentiating Effect of Caryophyllene on Anticancer Activity of Alpha-Humulene, Isocaryophyllene and , and Paclitaxel. Journal Pharm Pharmacol, 2007, vol 59, no 12, p. 1643.



Institute of Tropical
Disease
Universitas Airlangga

in a collaboration
with



Institute for Protein Research
Osaka University

Proceeding

Molecular and Cellular Life Sciences:
Infectious Diseases, Biochemistry and
Structural Biology
MCLS 2015

ISBN 978-602-14292-4-2

Beta Glucan from *Saccharomyces cerevisiae* Derived from the Local Ragi and Its Potential as Antioxidants

Kusmiati*, Ni Wayan S. Agustini

27

Research Center for Biotechnology, Indonesian Institute of Sciences, Jl. Raya Bogor Km 46, Cibinong- Bogor, Indonesia

Abstract

Four strains of *S. cerevisiae* have been isolated from the local ragi named *S. cerevisiae* RT03, RT12, RT14 and SAF and it was cultured respectively on GYP medium at 30°C. β -Glucan extraction using acid-base neutralization method. Analysis of functional groups was carried by FTIR. Levels of β -glucan equivalents glucose most of 6.9042% acquired by *S. cerevisiae* RT03 with 3.7065% of protein content. Beta glucan from local ragi tested its potential as antiradical DPPH. The results indicate that β -glucan from *S. cerevisiae* SAF has the highest antiradical DPPH activity with IC_{50} of 74.5 $\mu\text{g}\cdot\text{ml}^{-1}$, followed RT12, RT03 and RT14 with IC_{50} respectively 105, 5; 145.71 and 186.1 $\mu\text{g}\cdot\text{ml}^{-1}$. Fractionated by column chromatography showed stronger antiradical DPPH.

Keywords: Beta Glucan; *Saccharomyces cerevisiae*; antiradical DPPH

1. Introduction

30 Yeast is a well known microorganism that is used in biotechnology since ancient times. Therefore it is a good source of β -glucan (homopolymer of glucose). The cell wall of *Saccharomyces cerevisiae* consists of approximately 29-64% β -glucans, 31% mannans, 13% proteins, 9% lipids, and 1-2% chitin^{1,2}. However, the exact structure and composition of the yeast cell wall depends strongly on the cultivation conditions. The β -glucan component in the *Saccharomyces cerevisiae* cell wall, with the function of maintaining the rigidity and shape of the cell, is often named simply glucan or yeast glucan. That polysaccharide consists mainly of a linear central backbone of D-glucose linked in the β -(1 \rightarrow 3) position with glucose side branches (β -(1 \rightarrow 6)-linkage) of various sizes, which occurs at different intervals along the central backbone³. Triple helical multimer provides structure and support to the yeast cell wall. The native structure of β -glucans as well as their biological activities could be changed during isolation if harsh procedures are applied. Primary structure, solubility, degree of branching and molecular weight, as well as the charge of their polymers and structure in aqueous media, are responsible for biological activity of β -glucan. 12

Based on the structure, β -Glucan is a polysaccharide consisting of thousands of glucose units. The units of glucose on β -glucans are linked with β -glycosidic bond to form a polymer (Fig. 1).

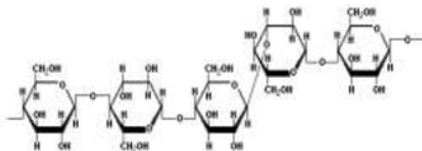

Fig.1 Structure of Beta Glucan.

* Corresponding author. Tel.: +62-021-8754587; fax:+62-021-8754588.
E-mail address: kusmiati02@yahoo.com

10 In recent years evidence suggested that biopolymers (like β -glucan) also exhibit antioxidative activity⁴. The exploration of antioxidants is of great interest because they are able to protect living organisms from the attack of reactive oxygen species (ROS), and in this way to decrease the risk of several degenerative diseases^{5,6}. *Saccharomyces cerevisiae* contains several endogenous substances which act as antioxidants^{7,8}.

In many living organisms, oxidation is essential for the production of energy to accelerate biological processes. However, when the mechanism of oxidation becomes unbalanced by factors such as aging, deterioration of physiological functions may occur resulting in diseases such as cancer, rheumatoid arthritis, and atherosclerosis⁹. Thus, maintenance of equilibrium between free radical production and antioxidant defenses (enzymatic and nonenzymatic) is an essential condition for normal organism functioning. Antioxidant supplements or foods containing antioxidants may be used to help the human body reduce oxidative damage¹⁰. Antioxidants are compounds that can delay or inhibit the mechanism of oxidation by blocking the initiation or propagation of oxidizing chain reactions. Several commercial synthetic antioxidants are widely used in food industry such as butylatedhydroxyanisole (BHA), butylatedhydroxytoluene (BHT), and tert-butylhydroquinone (TBHQ)¹¹. However, the utilization of these synthetic antioxidants becomes restricted due to their toxicity and carcinogenicity effects to the liver. Therefore, it is necessary to investigate and produce more effective natural antioxidants that are less harmful to human body. If it were to be shown that β -glucan, a natural component of grain, exerts antioxidant activity, the utility of β -glucan as a polymeric excipient for supplement or food additive would increase further. However, the antioxidant activity of β -glucan has not been extensively investigated.

In several regions in Indonesia, yeast used for fermentation of foods such as ice guess, lamang tapai, and also wine which is typical regional food or drink. Beta glucan derived from yeast isolated from sources of food and drinks. This research is focused to produce β -glucans from *S. cerevisiae* isolated from three local samples of yeast. The parameters measured are dry weight of β -Glucan crude (mg), characterization of β -glucans with Fourier Transform Infra Red (FTIR), β -Glucan levels equivalent glucose and protein levels were analyzed by UV-Vis spectrophotometer. For determination of radical scavenging activity of β -Glucan crude and β -Glucan fractionation results by column chromatography by using DPPH.

2. Methods

2.1. Microorganism and Media

Saccharomyces cerevisiae were isolated from four samples locally derived from Padang (RT03), Tasikmalaya (RT12), Pekalongan (RT14), and commercial instant yeast (SAF) as a comparison. The cultures were maintained on the medium of potato dextrose agar (PDA) at 4°C. The microorganisms were subcultured at regular intervals (2 months) to maintain viability. The inoculum was prepared by growing *S. cerevisiae* RT03, RT12, RT14 and SAF in Erlenmeyer flasks containing 50 mL of the GYP medium (w/v): yeast extract 1%, 2% peptone, 2% glucose on a rotary shaker at 150 rpm, for two days, at 25°C.

2.2. β -glucan production

82 Cultivation was carried out in Erlenmeyer flasks containing 300 mL of the GYP medium was inoculated with 2% (v/v) of the inoculum. The inoculum culture were RT03, RT12, RT14 and SAF cultivated triplicate for 6 days on a rotary shaker at 150 rpm at 25°C and cultivated for 6 days.

2.3. Extraction Beta Glucan (Alkali-acid method)

516 12 Beta glucan were isolated from the cell wall of *S. cerevisiae* by a combination method of Williams *et al*¹² and Hunter *et al*¹³. Briefly, the cell wall of *S. cerevisiae* was dispersed in 0.75 M (3%) sodium hydroxide (NaOH), and extracted in water bath at 75°C for 2 hours. The suspension was cooled to room temperature and centrifuged (4000 rpm, 10 min), the resulting pellet collected and this material then washed three times using 0.5 L distilled water. The residue was then mixed with 0.2 L of 0.75 M NaOH, and extracted in boiling water for 3 hours. Distilled water was then added to the cooled suspension, the pH adjusted to 7 with HCl, and the supernatant after centrifugation discarded. This water wash was repeated until the residue became white and flocculent, and finally the pellet was washed with absolute ethanol until the supernatant became colorless. Particulate glucan was obtained by drying the washed pellets by oven vacuum at 40°C^{12,13}.

2.4. FTIR analysis of β -glucan

54 β -Glucan were analyzed by FTIR-JASCO 4100 Spectrophotometer. IR spectra of the compounds were recorded for 400-4000 cm⁻¹ in KBr pellet using a FT-IR spectrophotometer.

2.5. β -glucan assay

β -glucan hydrolysis was added to aqueous 50% H₂SO₄ solution so that β -glucan concentration was 2 mg/ml. Hydrolysis was held for 24 h. Then solution was neutralized with 2 M NaOH aqueous solution (5 mL 2 M NaOH for 1 mL β -glucan hydrolysis solution with 50% H₂SO₄). Glucose monomers concentration in solutions was determined using phenol sulphuric acid method DuBois *et al*¹⁴. Protein concentration analysis was determined using Lowry protein assay¹⁵.

2.6. Glucose Analysis with Phenol-Sulfuric Acid method¹⁴

A 2 mL aliquot of a carbohydrate solution is mixed with 1 mL of 5% aqueous solution of phenol in a test tube. Subsequently, 5 mL of concentrated sulfuric acid is added rapidly to the mixture. After allowing the test tubes to stand for 10 min, they are vortexed for 30 second and placed for 20 minutes in a water bath at room temperature for color development. Then, light absorption at 490 nm is recorded on a spectrophotometer. Reference solutions are prepared in identical manner as above, except that the 2 mL aliquot of carbohydrate is replaced by water. The 5% phenol in water (w/w) was prepared immediately before the measurements.

2.7. Protein Analysis by Lowry method¹⁵

An amount of 0.25 mL of test solution was diluted with distilled water to 0.5 mL; 0.25 mL of 1 N NaOH was added and boiled for 20 minutes; 1.25 mL of solution of reagent D (50 ml Na₂CO₃ 5% 2.1 mL CuSO₄.5H₂O 1%, 1 ml of potassium tatarat 2%) was added, shaken in order to be homogeneous, and allowed to stand for ten minutes; 0.25 mL of Folin Ciocalteu was added that so blue color appeared, allowed to stand for 30 minutes, absorbance was measured using a UV-Vis spectrophotometer at a wavelength of 750 nm.

2.8. Determination of β -Glucan level as equivalent of Glucose and Protein Content Resulted from Fractionation

Fractionation performed by column chromatography using silica gel absorbent and eluent consisting of a mixture of n-butanol, ethanol, water (5 : 5 : 4 , v/v). The levels of β -Glucan as equivalents of glucose and protein levels of fractions resulted were analyzed as the assay prior to fractionation.

2.9. Determination of antioxidant activity Scavenging of 1,1-diphenyl-2-picrylhydrazyl (DPPH) free radical¹⁶

The DPPH radical scavenging activity was evaluated using the method of Son and Lewis (2002). DPPH radical solution (0.004%, w/v) in methanol p.a was prepared. A volume of 2 mL of DPPH in methanol was added to 2 mL of sample, well vortexed and incubated for 30 min in dark room at room temperature. Absorbance of each sample at 517 nm was measured using UV-Visible spectrophotometer (Shimadzu). Methanol was used as a blank, while DPPH solution in methanol served as control. Vitamine E (Sigma) was used for comparison. The antioxidant activity was expressed as percentage of DPPH activity calculated as:

$$\text{DPPH activity (\%)} = \frac{\text{Absorbance of blank} - \text{absorbance of sample}}{\text{Absorbance of blank}} \times 100$$

Calculating IC₅₀ using linear regression $y = a + bx$

$$\begin{array}{ll} \text{Whereas : } y = 50 & a = \text{intercept} \\ x = \text{IC}_{50} & b = \text{slope/tilt} \\ & r = \text{correlation coefficient} \end{array}$$

The value of IC₅₀ (Inhibition Concentration 50%) indicated that concentrations of β -glucan could inhibit 50% of the activity of free radicals (DPPH). β -Glucan is declared to be potentially antioxidant if the value of IC₅₀ was less than 200 pg/ml¹⁷.

391

3. Results and discussion

3.1. Dry weight of beta glucan crude

The use of four isolates of *S. cerevisiae* produced distinctive dry weight of β -glucan. The highest result obtained by isolates of *S. cerevisiae* RT 12 at 2.970 g.L⁻¹, whereas the lowest was obtained by isolates of *S. cerevisiae* RT03 at 0.428 g.L⁻¹ (Table 1). Differences in the production of β -Glucan in four isolates of *S. cerevisiae* are due to the differences in genetic trait. The genetic differences can affect the result of fermentation of *S. cerevisiae*

Table 1. Dry weight of β -glucan crude from 4 different strains of *Saccharomyces cerevisiae* (g.L^{-1})

No	Sample <i>S. cerevisiae</i>	dry weight of β -glucan
1	RT03	0.428
2	RT12	2.970
3	RT14	2.380
4	SAF	2.000

3.2. β -Glucan crude Analysis by FTIR

FTIR results showed that β -glucans crude from four isolates of *S. cerevisiae* have functional groups according to the structure of the β -glucans standards from Takeda-Japan. The FT-IR spectra of the glucans are shown in Fig. 2, were obtained functional group of -OH (alcohol), -C-C-C- (alkane), and -R-O-R (ether) (Table 2).

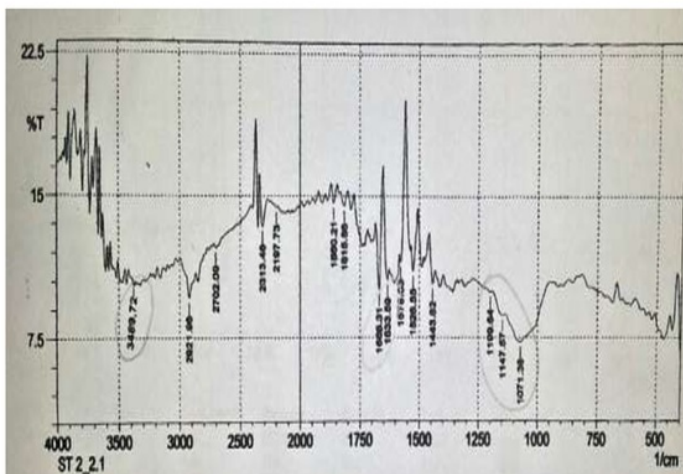

Fig. 2. FTIR spectra of beta 1,3-glucan (Takeda- Japan)

Table 2. Analysis of functional groups of β -glucans crude from 4 isolates of *S. cerevisiae* by FTIR

Functional Groups	Wave number Literature (cm^{-1}) ¹⁷	Wave number sample (cm^{-1})				
		<i>S. cerevisiae</i>				
		Std of β Glucan	RT 03	RT 12	RT 14	SAF
stretch -OH	3000 – 3700	3173.65	3489.72	3456.20	3357.84	3279.73
				3332.76		
stretch -C-C-C	1680-1600	1608.52	1633.59	1657.70	1638.42	1663.49
		1668.31	1668.31		1628.77	
stretch -R-O-R	1050-1260	1075.24	1071.38	1133.10	1080.06	1157.21
		1155.28	1147.57	1157.21	1153.35	
		1228.57	1199.64			

3.3. Levels of β -Glucan as equivalent of glucose and protein

43

Phenol-Sulfuric Acid method, this is the most widely used colorimetric method for determination of carbohydrate concentration in aqueous solutions¹⁴. The basic principle of this method is that carbohydrates, when dehydrated by reaction with concentrated sulfuric acid, produce furfural derivatives. Further reaction between furfural derivatives and phenol develops detectable color.

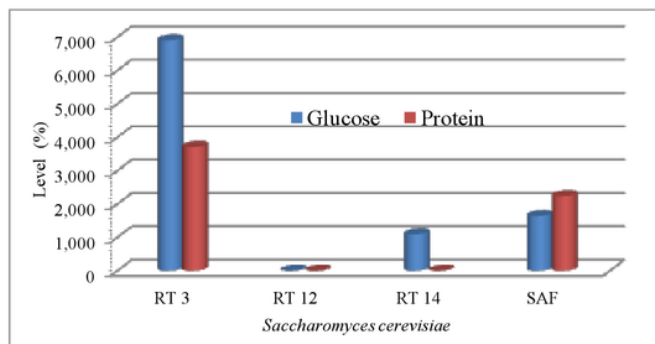

Fig 3. Levels of β -Glucan equivalent glucose and protein levels of 4 isolates *S. cerevisiae* with Spectrophotometer UV-Vis λ 490 nm

3.4. β -Glucan levels as equivalent of glucose

Assay was conducting by using Phenol-Sulfuric Acid. The analysis is done because glucose is the monomer of β -Glucan. The four different *S. cerevisiae* isolates produce different glucose levels, it can be caused by genetic factors of the strain and the influence of environmental factors both physically and chemically. Each strain requires specific conditions for optimum growth. The highest results of the analysis of the levels of β -Glucan glucose as equivalents obtained by *S. cerevisiae* RT03 isolates at 6.9042%, while the levels of β -Glucan lowest glucose as equivalents obtained by *S. cerevisiae* RT12 isolates at 0.7855% (Table 3). The results of statistical analysis of β -Glucan level as equivalent of glucose showed that *S. cerevisiae* RT03 highly distinctive to the other isolates.

3.5. Protein Content

The Lowry method for total protein determination is one of the most common colorimetric assays performed by biochemists. This procedure lies in the reactivity of the peptide bonds with the Cu^{2+} under alkaline conditions and the subsequent reduction of the Folin-Ciocalteu phosphomolybdic phosphotungstic acid to heteropoly molybdenum blue by the copper-catalyzed oxidation of aromatic acids. The Lowry method is sensitive to low concentrations of protein. The major disadvantage of the Lowry method is the narrow pH range within which it is accurate. However, in this experiment very small volumes of sample are used which have little or no effect on pH of the reaction mixture. A variety of compounds (some amino acid derivatives, zwitter ionic and non ionic buffers, drugs, lipids, sugars, salts, nucleic acids, sulphhydryl reagents, ammonium ions and thiol compounds) can interfere with the Lowry procedure¹⁵.

The protein content was analyzed for *S. cerevisiae* cell walls contained β -Glucan in the form of complex compounds bound as proteoglycan. Protein content in the crude β -Glucan is expected to be as low as possible for applications in the field of food and pharmaceuticals. It is projected to avoid the consumer become allergic to a particular protein. Nitrogen source in the fermentation medium was used for protein synthesis in the cell. The existence of the cell absorption of this nitrogen source causes the protein content in the media increasingly reduce along with the length of fermentation time. The analysis results showed that the highest protein content was obtained by isolates of *S. cerevisiae* RT03 at 3.7065%, while the lowest was obtained by isolates of *S. cerevisiae* RT12 at 0.4432% (Table 3). The statistical analysis showed that the protein content of the isolates of *S. cerevisiae* RT12 and RT14 are not significantly different, while RT03 and SAF showed significant difference (Table 3).

3.6. Ratio of β -Glucan levels as equivalent of Glucose: the protein content of the highest fractionation results

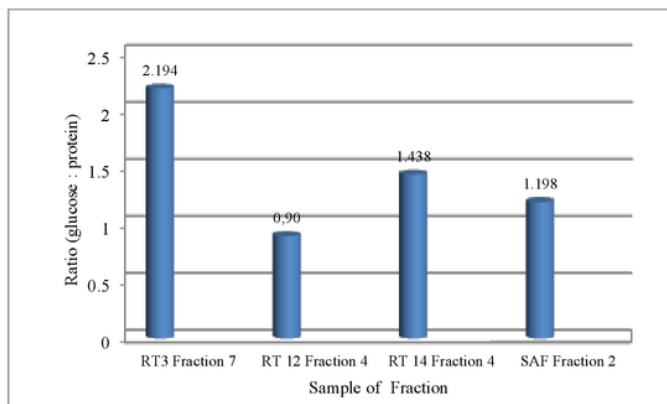

Fig. 4. Ratio of β -Glucan levels as equivalent of glucose: the protein content of the four isolates *S. cerevisiae* fractionation results

Fractionation was conducted to obtain a more pure extract with a ratio of β -Glucan levels as equivalent of glucose to the higher protein content compared to the protein content before fractionation. Fractionation was performed using column chromatography. The β -Glucan levels as equivalent of glucose of the samples column results were then analyzed with the phenol sulfate method and protein content was analyzed by Lowry method. The analysis showed that the ratio of levels of β -Glucan as equivalent of glucose: the highest protein content was produced by isolates of *S. cerevisiae* RT03 (fraction 7) of 1.1348, while the ratio of levels of β -Glucan as equivalent of glucose: the lowest protein content was produced by isolates of *S. cerevisiae* RT14 (fraction 4) of 0.8247. Levels β -Glucan as equivalent of glucose and protein levels of β -Glucan compound after fractionated lowered. It is due to the components of other compounds contained in crude β -Glucan was eliminated in the process of fractionation using column chromatography.

54

3.7. Antioxidant activity of β -glucan from 4 isolates of *S. cerevisiae* by DPPH free radical scavenging assay.

Fractionation of β -glucan each sample of four isolates of *S. cerevisiae* using column chromatography obtained 10 fractions. Then, three fractions were chosen based on the highest ratio of glucose and protein level for testing the antioxidant potential. Next, one fraction, that is potential as an anti-radical DPPH to be compared with the test results crude β -glucan, was chosen. Analysis was performed using UV-Vis spectrophotometer at λ 517 nm, which is the highest uptake of compounds DPPH. DPPH solution was purple in methanol, purple color changed to yellow when reacted with antioxidants. DPPH color reduction occurred because of the existence of compounds that can provide radical hydrogen to DPPH radicals, so they were reduced to DPPH-H (1,1-diphenyl-2-picrylhydrazyl-hydrate) and became more stable. It is seen when measuring absorption by UV-Vis spectrophotometer i.e. the solution poured into the cuvette turned into a reddish yellow. Experiments were performed using vitamin E as a positive control.

The measurement results show that vitamin E has IC_{50} value of 33.55 μ g /ml, RT03, RT12, RT14 β -glucan and SAF consecutively 145.71; 105.5; 186.1; and 74.5 μ g /ml. The result of β -glucan extract test compared to fractionated samples was that RT03 β -glucan fraction -7 generated IC_{50} value of 122.7 μ g /ml, RT12 β -glucan fraction -4 produced 99.4 μ g/ml, RT14 β -glucan fraction-4 produced 155.85 μ g/ml, β -glucan fraction SAF-2 fraction 55.9 μ g/ml. Beta glucan sample fractionation by column chromatography showed increased activity of DPPH radical, as shown by the declining value of IC_{50} . Fractionated sample extract produced more pure β -glucan because separation had been done by column chromatography. Based on the results obtained, all test samples as potentially anti-radical DPPH IC_{50} because the values were below 200 μ g/ml. Observations results can be seen in Table 4 and 5. The highest antioxidant potential was produced by vitamin E as a positive control followed by sample of β -glucan *S. cerevisiae* successively SAF, RT12, RT03 and RT14.

514

Table 3. DPPH radical scavenging activity and IC₅₀ value of beta glucan *S. cerevisiae* (RT03, RT12, RT14, and SAF) and positive control (Vitamin E)

Sample Code	Concentration (µg/ml)	Inhibition (%)	Linear Equations	Y= a + bx	IC ₅₀ (µg/ml)
RT03	50	45.716	50 = 43.443 + 0.045 x r = 0.999		145.71
	75	46.853			
	100	47.989			
RT12	50	41.870	50 = 34.906 + 0.143 x r = 0.995		105.5
	75	46.066			
	100	49.038			
RT14	50	45.804	50 = 44.230 + 0.031 x r = 0.999		186.1
	75	46.590			
	100	47.377			
SAF	50	45.45	50 = 36.58 + 0.18 x r = 0.998		74.5
	75	50.34			
	100	54.45			
Vitamin E (Positive Control)	50	50.586	50 = 48.497 + 0.045 x r = 0.969		33.55
	75	52.209			
	100	52.840			

Table 4. DPPH radical scavenging activity and IC₅₀ value of beta glucan *S. cerevisiae* (RT03, RT12, RT14, and SAF) fractionation results.

Sample Code	Fraction	Concentration (µg/ml)	Inhibition (%)	Linear Equations	Y= a + bx	IC ₅₀ (µg/ml)
RT03	7	12.5	17.30	50 = 15.64 + 0.28 x r = 0.891		122.7
		25	25.96			
		50	28.93			
RT12	4	12.5	12.41	50 = 5.24 + 0.45 x r = 0.973		99.4
		25	14.24			
		50	28.58			
RT14	4	12.5	10.57	50 = 6.98 + 0.28 x r = 0.999		155.8
		25	13.72			
		50	20.89			
SAF	2	12.5	13.81	50 = 6.07 + 0.78 x r = 0.983		55.90
		25	28.84			
		50	44.31			

4. Conclusions

The highest β-Glucan Dry Weight was obtained by isolates of *S. cerevisiae* RT12 at 111.3 mg, whereas the lowest was obtained by isolates of *S. cerevisiae* RT03 at 14.4 mg. Characterization of crude β-Glucan from four isolates of *S. cerevisiae* using FTIR showed that each of the four isolates had its functional group that was similar to the standard β-Glucan compounds. Isolate *S. cerevisiae* RT03 originally from Payakumbuh West Sumatra-Indonesia, gave the best results with levels of β-Glucan as equivalents of glucose amounted to 6.9042% and 3.7065% for protein content. Samples of β-Glucan *S. cerevisiae* RT03 resulted from fractionation namely Fraction 7 had the highest levels ratio of β-Glucan as equivalent of glucose: the highest protein at 1.1348. Samples of β-Glucan *S. cerevisiae* SAF had the lowest IC₅₀ value indicating the highest potential ant radical DPPH. The fractionation of the four sample of β-glucan *S. cerevisiae* had IC₅₀ values lower than β-Glucan crude of *S. cerevisiae*.

Acknowledgements

The authors wishes to thank S. Sofyani for skilfull technical assistance with beta glucan preparation and D. Larisa for antioxidant assay preparation.

References

234

- Kath, F.; Kulicke, W. M. Mild enzymatic isolation of mannan and glucan from yeast *Saccharomyces cerevisiae*. *Macromol. Chem.* 1999, **268**: 59-68.
- Fleet, G. H.; Manners, D. J. Isolation and composition of an alkali-soluble glucan from cell-walls of *Saccharomyces cerevisiae*. *J. Gen. Microbiol.* 1976, **94**: 180-192.
- Gardiner T. β-Glucan biological activities: A review, *Glycoscience and Nutrition*, 2000, **1**: 1- 6.
- Tsiapali, E.; Whaley, J.; Kalbfleisch, H.; Ensley, H.; Browder, W.; Williams, D. Glucans and related natural polymers exhibit weak

- solution free radical scavenging activity, but stimulate free radical activity in a murine macrophagen cell line. *Free Rad.Biol. Med.* 2001. **30**: 393-402.
5. Babincova, M.; Sourivong, P. Free radical scavenging activity of *Scoparia dulcis* extract. *J. Med. Food* 2001. **4**: 179-181.
 6. Wang, P.; Kang, J.; Zheng, R.; Yang, Z.; Lu, J.; Gao, J.; Jia, Z. Scavenging effects of phenylpropanoid glycosides from *Pedicularisone* superoxide anion and hydroxyl radical by the spin trapping method. *Biochem. Pharmacol.* 1996. **51**: 687-691.
 7. Demasi, A. P.; Pereira, G. A.; Netto, L. E. Cytosolic thioredoxin peroxidase I is essential for the antioxidant defence of yeast with dysfunctional mitochondria. *Fed. Eur. Biochem. Soc. Lett.* 2001. **509**: 430-434.
 8. Pinheiro, R.; Belo, I.; Mota, M. Oxidative stress response of *Kluyveromyces marxianus* to hydrogen peroxide, paraquat and pressure. *Appl. Microbiol. Biotechnol.* 2002. **58**: 842-847.
 9. Xu, W., F. Zhang, Y. Luo, L. Ma, X. Kou and K. Huang. Antioxidant activity of a water-soluble polysaccharide purified from *Pteridium aquilinum*. *Carbohydrate Res.* 2009. **344**: 217-222.
 10. Wu, X.J. and C. Hansen. Antioxidant capacity, phenol content and polysaccharide content of *Lentinus edodes* grown in whey permeate-based submerged culture. *J. Food. Sci.* 2008. **73**: 1-8.
 11. Cheung, L.M. P.C.K. Cheung and V.E.C Ooi. Antioxidant activity and total phenolics of edible mushroom extracts. *Food Chem.*, 2003. **81**: 249-255.
 12. Williams, D.I. H. A. Pretus, R. B. McNamee *et al.*, Development, physicochemical characterization and preclinical efficacy evaluation of a water soluble glucan sulfate derived from *Saccharomyces cerevisiae*, *Immunopharmacology*, 1991. **22**: 139-156.
 13. Hunter J, KW., RA Gault, MD Berner. Preparation of microparticulate β -glucan from *Saccharomyces cerevisiae* for use in immune potentiation. *Letters in Appl Microbiol* 2005; **35**: 267-71.
 14. DuBois, M., Gilles, K., Hamilton, J., Rebers, P., & Smith, F. Colorimetric method for determination of sugars and related substances In *Albalasmeh, A.A., et al.* A new method for rapid determination of carbohydrate and total carbon concentrations using UV spectrophotometry. *Carbohydrate Polymers* 2013; **97**: 253- 261.
 15. Lowry Oliver H. Lowry, Nira J. Rosebrough, A. Lewis Farr, And Rose J. Randall. Protein Measurement With The Folin Phenol Reagent. *J. Biol. Chem.* 1951; **193**: 265-275.
 16. Son S, Lewis BA. Free radical scavenging and antioxidative activity of caffeic acid amide and ester analogues: Structure- activity relationship. *J. Agric. Food Chem.* 2002; **50**: 468-472.
 17. Patel Rajesh M.1 and Patel Natvar J.2. In vitro antioxidant activity of coumarin compounds by DPPH, Super oxide and nitric oxide free radical scavenging methods. *Journal of Advanced Pharmacy Education & Research.* 2011. 52-68.



Institute of Tropical
Disease
Universitas Airlangga

in a collaboration
with



Institute for Protein Research
Osaka University

Proceeding

Molecular and Cellular Life Sciences:
Infectious Diseases, Biochemistry and
Structural Biology
MCLS 2015

ISBN 978-602-14292-4-2

Anti-tuberculosis Activity of Chloroform and Methanol Extracts of *Michelia champaca* L. Stem Bark against *Mycobacterium tuberculosis* MDR

Ni Putu Ariantari^{a*}, Ni Putu Eka Widayanti^a, Ida Bagus Nyoman Putra Dwija^b

^aDepartment of Pharmacy, Faculty of Mathematics and Natural Sciences, Udayana University, Jalan Kampus Bukit-Jimbaran, Badung, Bali 80364, Indonesia

^bDepartment of Microbiology, Faculty of Medicine, Udayana University, Denpasar, Bali 80232, Indonesia

Abstract

Michelia champaca L. stem bark Magnoliaceae, was traditionally used to treat cough based on Ayurveda. This research was conducted to evaluate the anti-tuberculosis activity of chloroform and methanol extract of *M. champaca* against *Mycobacterium tuberculosis* MDR. Extraction was conducted by successive extraction with *n*-hexane, chloroform and methanol. Anti-tuberculosis activity test was done by using proportion method with Lowenstein Jensen medium and extract concentration of 1, 10 and 100 mg/mL then incubated in 5% CO₂ incubator at 37°C for six weeks. Bacterial colonies were observed from 3rd to 6th week. Anti-tuberculosis activity was determined by inhibition of extract against *M. tuberculosis*, which was calculated by comparing amount of colonies of treatment group to control. TLC Densitometry of extracts showed that terpenoids and flavonoids were detected in chloroform and methanol extracts. Extracts used in this study were active as anti-tuberculosis with the inhibition against *M. tuberculosis* MDR above 90% at extract concentration of 10 and 100 mg/mL.

Keywords: *Michelia champaca* L.; terpenoid; flavonoid; anti-tuberculosis; *Mycobacterium tuberculosis* MDR; extracts

1. Introduction

The incidence of tuberculosis has been significantly increasing in the last decade around the world. In 2012, there are 730.000 cases with a mortality rate of 27%¹². Increasing cases of tuberculosis caused by various factors, such as treatment failure, drop out of treatment, improper treatment, patients with HIV infection, and poor drug absorption that resulted in the appearance of resistance of *Mycobacterium tuberculosis* to current anti-tuberculosis drugs. In Indonesia, tuberculosis still becomes health problem, both in terms of mortality, diagnosis and treatment. According to the WHO Global Report 2012, Indonesia was ranked ninth out of 27 countries with the highest burden of multi-drug resistant (MDR) tuberculosis in the world¹¹. MDR tuberculosis is estimated at 1.9% of all new cases and 12% of the cases of tuberculosis with re-treatment¹². The problem of drug resistance is pushing the need for appropriate strategies in controlling MDR tuberculosis.

Exploring the potential of plants used in traditional medicine is one of important strategy that has been conducting. *Michelia champaca* which is commonly known as Cempaka Kuning is traditionally used as cough remedy. The traditional usage of this plant is commonly as infusion. Several pharmacological activities of this plant have been reported. Ariantari *et al.* (2013), has been reported for the antimalarial activity against *Plasmodium falciparum* 3D7 of *n*-hexane, chloroform and methanol extract of *M. champaca* stem bark. Methanol extract of leaves, seeds, stem and root barks, stem and root heartwoods of *M. champaca* is also reported for its pharmacological activity as antimicrobial⁶. Flowers extract of *M. champaca* revealed antidiabetic activity in alloxan induced diabetes model⁵, antiinflammatory activity¹ and wound healing activity in Wistar rats⁹. In present study we investigate the anti-tuberculosis activity of chloroform and methanol extract of *M. champaca* stem bark against *M. tuberculosis* MDR.

* Corresponding author. Tel.: +62-0361-703137; fax: +62-0361-703137
E-mail address: ari_dedhika@yahoo.com

2. Methods

2.1. Plant material

Stembark was collected in September 2012, from Pupuan Tabanan Bali-Indonesia. Plant specimen has been identified at Kebun Raya Eka Karya, Bedugul, Tabanan-Indonesia.

2.2. Bacteria

M. tuberculosis MDR was derived from Clinical Microbiology Department, Sanglah General Hospital, Denpasar, Bali-Indonesia.

2.3. Procedures

2.3.1. Extraction

Coarsely dried *M. champaca* stembark powdered (1 kg) was extracted with n-hexane (10 L) to remove resins and fatty acid. Residu then extracted successively with chloroform (10 L) and methanol (10 L) to obtain chloroform extract (13.33 g) and methanol extract (25.83 g).

TLC Densitometry of extract was done using Silica gel GF₂₅₄ as stationary phase and chloroform : methanol (95.0 : 5.0) as mobile phase. Ammonia and 10% sulfuric acid was used as spray reagent.

2.3.2. Anti-tuberculosis Activity Assay

Anti-tuberculosis activity assay was done by using proportion method refer to method previously reported by Gupta *et al.* (2010). Addition of extracts into Lowenstein-Jensen medium to get serial concentration of extract of 1, 10, and 100 mg/mL. Control received 1% of dimethylsulfoxide. *M. Tuberculosis* MDR inoculated on this medium then incubated in 5% CO₂ incubator, 37°C for 6 weeks. Colonies growth as colony forming unit (cfu) was observed three times a week starting from 3rd until 6th week. Anti-tuberculosis activity of extract was determined from percentage of inhibition of extract against *M. Tuberculosis* growth, which was calculated by comparing colonies growth in treatment group to control.

3. Results and discussion

Chromatogram profile of *M. champaca* stembark extract showed the presence of flavonoids (rf 0.78) and terpenoids both in chloroform and methanol extracts. Ammonia is used to detect the presence of the flavonoids and 10% sulphuric acid is used to detect the presence of terpenoids. Spot with rf 0.78 both in chloroform and methanol extract showed yellow fluorescent under 366 nm UV light and color changes to yellow orange after sprayed with ammonia indicated the presence of flavonoid. Refer to Markham (1988), the possibility of this flavonoid could be a flavonol 3-OH-free with/without free 5-OH or a dihydroflavonol. This spot has different color intensity in chloroform and methanol extracts. Chloroform extract showed more intensive color spot than methanol extract. The AUC value of this yellow spot (rf 0.78) in chloroform extract (62.97%) also higher than spot in methanol extract (60.11%). According to Markham (1988), flavonoid spectrum consists of two maxima in the range of 240-285 nm (Band II) and 300-550 nm (Band I). Spectrum of spot rf 0.78 of chloroform extract revealed maxima wavelength of 277 nm (Band II) and the shoulder peak wavelength of 324 nm (Band I). Compared to UV spectrum of flavonoid class proposed by Markham (1988), UV spectrum of spot rf 0.78 of chloroform and methanol extract are similar to dihydroflavonol. Terpenoids form a pink to purple spot after being sprayed with 10% sulphuric acid. Spot with rf 0.90 both in chloroform and methanol extract are belonged to terpenoids. The result of anti-tuberculosis activity of these extract was showed in Table 1.

Inhibition of both chloroform and methanol extracts of *M. champaca* with concentration of 1 mg/mL against *M. tuberculosis* MDR was under 90%. The increasing concentration of extracts (10 and 100 mg/mL) give higher inhibition against *M. tuberculosis* MDR with inhibition above 90%. According Gupta *et al.* (2010), extract was active as anti-tuberculosis when its inhibition above 90%. Therefore, chloroform and methanol extracts of *M. champaca* were active and potential as new agent for anti-tuberculosis. Flavonoids and terpenoids might be contributed for its activity.

Table 1. Anti-tuberculosis activity of chloroform and methanol extract of *M. champaca*

No. observation	Inhibition of extract against <i>M. tuberculosis</i> MDR (%)						
	Concentration of chloroform extract (mg/mL)			Concentration of methanol extract (mg/mL)			
		1	10	100	1	10	100
3 rd week	1	25.00	100	100	12.50	100	100
	2	34.62	100	100	19.23	100	100
	3	37.25	100	100	43.14	100	100
4 th week	4	37.14	100	100	38.57	100	100
	5	41.38	97.70	100	37.93	100	100
	6	41.75	98.06	100	33.01	100	100
5 th week	7	42.74	97.44	100	23.93	100	100
	8	42.50	96.67	100	22.50	100	100
	9	42.40	96.00	100	17.60	100	100
6 th week	10	41.73	95.28	100	18.11	100	100
	11	42.42	92.42	100	19.70	100	100
	12	39.85	91.73	100	18.05	100	100

Several studies also reported anti-tuberculosis activity of flavonoids and terpenoids. Sesquiterpene lactone partenolida and costunolida from *Magnolia grandiflora* and *Magnolia virginiana* (Magnoliaceae) were reported to have anti-tuberculosis activity against *M. tuberculosis* H37Rv with MIC of 16 and 32 $\mu\text{g/mL}$ ³. Dihydroflavonol, laburnetin, isolated from *Ficuschlamydocarpa* and *Fiscuscordata* exhibited anti-tuberculosis activity with MIC values of 4.88 $\mu\text{g/mL}$ ⁷. Flavanones isolated from *Chromolaenaodorata* also revealed anti-tuberculosis activity with MIC values of 174.8 μM ¹⁰.

4. Conclusions

Chloroform and methanol extracts of *M. Champaca* stembark is active as anti-tuberculosis. Further researches are needed to isolate active phytochemical constituents as anti-tuberculosis from chloroform and methanol extracts of *M. champaca* stembark.

Acknowledgements

This work was supported by Grant for Competition Research from Directorate General of Higher Education, The Ministry of Education and Culture, Republic of Indonesia.

References

- Ananthi T, Chitra M. Screening in vitro antiinflammatory activity of *Michelia champaca* Linn Flowers. *Asian Journal of Pharmaceutical and Clinical Research*. 2013; **6**(5).
- Ariantari N P, Rustini N L, Tumewu L, Hafid A F, Widyawaruyanti A. Kajian Potensi Antimalaria Kandungan Kimia dari Kulit Batang *Michelia champaca* L. Terhadap *Plasmodium falciparum* 3D7. *Jurnal Ilmu Kefarmasian Indonesia*. 2013; **11**(1): 2-3.
- Fischer N H, Lu T, Cantrell C L, Casteneda-Acosta J, Quijano L, Franzblau S G. Antimycobacterial Evaluation of Germacranolides. *Phytochemistry*. 1998;**49**:559. Abstract.
- Gupta R, Thakur B, Singh P, Singh HB, Sharma V D, Katoch VM, ChauhanSVS. Anti-tuberculosis Activity of Selected Medicinal Plants Against Multi-drug Resistant *Mycobacterium tuberculosis* Isolates. *International Journal Medicine Research*. 2010; **131**: 809-813.
- Jarald EE, Joshi SB, Jain DC. Antidiabetic activity of flower buds of *Michelia champaca* Linn. *Indian J. Pharmacol*2008;**40**(6): 258-260.
- Khan MR, Kihara M, Olomoso AD. Antimicrobial activity of *Michelia champaca*. *Fitoterapia*. 2002;**73**: 744-748.
- Kuete V, Ngameni B, Fotso-SimoC C, Kengap T R, Tchaleu N B, Meyer J J M , Lall N, Kuiate JR. Antimicrobial activity of the crude extracts and compounds from *Ficuschlamydocarpa* and *Fiscuscordata* (Moraceae). *J Ethnopharmacol*. 2008; **120**:17-24.
- Markham K R. *Cara Mengidentifikasi Flavonoid*. Bandung: ITB Press; 1988.
- Shanbag T, Kodidela S, Shenoy S, Amuthan A, Kurra S. Effect of Micheliachampaca Linn Flowers on Burn Wound healing in wistar rat. *International Journal of Pharmaceutical Sciences Review and Research*. 2011;**7**(2): 112-115.
- Suksamram A, Chotipong A, Suavansri T, Boongird S, Timsuksai P, Vimuttipong S, Chuaynugul A. Antimycobacterial activity and cytotoxicity of flavonoids from the flowers of *Chromolaenaodorata*. *Archives of Pharmacal Research*. 2004; **27**(5): 507-511.
- WHO. *Global Tuberculosis Report 2012*. France: World Health Organization; 2012.
- WHO. *Global Tuberculosis Report 2013*. France: World Health Organization; 2013.



Institute of Tropical
Disease
Universitas Airlangga

in a collaboration
with



Institute for Protein Research
Osaka University

Proceeding

Molecular and Cellular Life Sciences:
Infectious Diseases, Biochemistry and
Structural Biology
MCLS 2015

ISBN 978-602-14292-4-2

Determination of free Prostate of Specific Antigen (fPSA) in Normal Patients Using The Immunoradiometric assay (IRMA) PSA Kit Developed in Center for Radioisotopes and Radiopharmaceuticals Technology National Nuclear Energy Agency

Puji Widayati^{a*}, Cynthia Nikopama^b, Fadil Nazir^c, Agus Ariyanto^a, Widyastuti^a

^aCenter for Radioisotopes and Radiopharmaceuticals Technology (CRRT), National Nuclear Energy Agency (NNEA), Puspiptek Area, Serpong, Tangerang, Banten, 15314, Indonesia

^bCenter for Informatica and Nuclear Strategic Zone Utilization (CINSZU), National Nuclear Energy Agency (NNEA) Puspiptek Area, Serpong, Tangerang, Banten 15314, Indonesia

^cCenter for Radiation Safety Technology and Metrology (CRSTM) Lebak Bulus Raya, National Nuclear Energy Agency (NNEA), Pasar Jum'at, Jakarta Selatan, Indonesia

Abstract

Prostate cancer is a cancer in the male reproduction system that can spread to the bones and lymph nodes. Prostate cancer is a very frequent cause of mortality of about 2-3% in men. One of the prevention of prostate cancer is done by early detection screening which is recommended for men over 40 years old. PSA is an enzyme released by prostate gland that can be determined by IRMA or ELISA method. Center for Radioisotopes and Radiopharmaceuticals Technology has developed a reagent kit in the form of IRMA PSA tracer, PSA standard and coated tube that gave the NSB of 0.9% and %B/T 19.57. The values met the requirements of a good kit (%NSB < 2% and %B/T > 10%). The standard calibration curve showed a high level of confidence of linear equation $Y = 0.2346X + 0.922$, with the value of $R^2 = 0.998$. The purpose of this study is to determine the sensitivity, specificity and accuracy of PSA IRMA kit developed in the CRRT by determination of PSA level of the NNEA employees (normal patients) compared with the result using the PSA IRMA kit of commercial product. The results showed that the sensitivity, specificity and accuracy are 11.76%, 94.80% and 85.96% respectively.

Keywords: prostate cancer; PSA; IRMA; 125I; diagnosis.

1. Introduction

Prostate cancer is the most malignant among other specific urogenital systems on males. This type of cancer can grow and spread to the surrounding lymph nodes and in its late stadium it might affect the nearest or farthest organs resulting in the bone destruction. The prostate cancer attributes to 2-3 percent of male deaths. The cancer cells can spread faster due to the influence of testosterone hormone and can be impeded by the removal of testis by injecting estrogen hormone. In some cases the metastasis cancer to the bone can be cured in months or years by removing testis through the estrogen hormone therapy or both. After the treatment the metastasis will degenerate and the spreading to bones disappears. The treatment does not completely stop the prostate cancer but it can slow down and reduce the bone pains significantly¹. One of the methods in the prevention of prostate cancer is by early detection through screening, recommended for males starting at the age of 40. PSA is an enzyme produced by the prostate gland, which content can be measured through either IRMA or ELISA method².

The IRMA method uses a binding technique between antigen and radionuclide labeled antibody. The antigen will bind parts of the antibody, the free antibody is then removed by adding solid antigens, and radioactive labeled antibody bound to antigen in liquid is then measured. The detected radioactivity is equivalent to the number of antigens. The technique is highly suitable for determining tumor markers in the complex matrix serum and the content of which is highly varied. This assay technique is based on the reaction between antigen (Ag) found in the sample or standard (tumor marker) with the excessive radioiodinated antibody (Ab*) which

* Corresponding author. Tel.: -; fax: -;
E-mail address: pujiw@batan.go.id

forms antigen-antibody complex (Ag-Ab*). Therefore, the higher the content of tumor marker (Ag), the higher the antigen-antibody complex, thereby producing the higher radioactive count³.

Enzyme Linked Immunosorbent Assay (ELISA) is used to determine antibody. In this respect, the antigen is firstly tied to solid substance then the antibody of interest is added. Next, the enzyme marked antigen such as peroxidase and phosphatase is added. Then, chromogenic substrate is added which produces color change when it reacts with the enzyme. The change of color occurs in line with the number of tied enzymes and also in line with the antibody being searched. In the ELISA test, the more stable but less sensitive reagent compared to RIA/IRMA reagent is used^{4,5}.

Prostate Specific Antigen is a glycoprotein with molecular weight of 34,000 dalton produced mainly by epithel cells that coat asinus and prostate gland tract. At a normal state, only a little amount of PSA gets into the blood circulation but if inflammation or damage occurs at the prostate tract, the PSA content in the blood increases. The increase in the PSA content may be resulted from prostate cancer or benign prostatic hyperplasia (BPH). The blood PSA is found in free condition (free PSA) and most of it is tied by protein (complexed PSA/c-PSA). In the case of prostate cancer the increase of c-PSA is more dominant compared to the free PSA concentration, whereas in the BPH case the free PSA is more dominant. For males of over 60 years old, the result of PSA measure can be misleading, as to whether it is caused by BPH or prostate cancer; therefore, it is advisable to conduct an examination when the ratio of free PSA/PSA-total or ratio of c-PSA/PSA total, particularly for those whose total PSA content is between 2.6-10 ng/mL. The result of interpretation is as follows: if the ratio of free-PSA/PSA total <10%, it is predicted as prostate cancer, 10%-25% as BPH, >25% as BPH. PSA examination is conducted for the purpose of screening (PSA total), diagnosis (PSA total and ratio of free-PSA/PSA-total or ratio of c-PSA/PSA-total), for disease and treatment monitoring after the removal of prostate⁶.

The treatment procedure for prostate cancer at the early stadium is by conducting observation, then in the next stadium it is advisable to remove prostate glands (radical prostatectomy) or radiation therapy, and at the further metastasis stadium the hormonal treatment has to be made to reduce or get rid of androgen hormonal influence to the prostate tissue. Other important action is to check the PSA content regularly for the post radical prostatectomy patients and hormonal treatment to check relapses^{8,12,13,15,18}.

In 2012 the CRRT successfully developed IRMA PSA reagent kit in the form of PSA tracer, coated tube and the standard with %NSB of 1.26 and %B/T of 14.12 to meet the proper kit requirements (%NSB<2% and %B/T>10%) under standardised calibration curve that suggested the particularly strong relation shown by R² 0.9938 value obtained from the equation of linear regression line $Y=0.1247X + 1.7099$ ⁹.

In 2013 the IRMA PSA kit assay was optimised, including reagents and reaction condition so that optimum condition was reached by standardised volume composition of 50 μ L, successive (tracer) activity of 50000 cpm and successive (tracer) volume of 25 μ L as well as optimum reaction with the incubation period of 18 hours and incubation temperature of 25°C. The preaction and reaction condition produce immunology results of %B/T and %NSB of 21.67% and 0.26% respectively to meet the proper kit requirements¹⁰. Using the optimum condition and reagent, validation of IRMA PSA was conducted by determining the detection limit, accuracy (intra and inter assay), assay performance and kit stability with the following results: detection limits to enable % CV of 14.43, intra assay precision performed by one operator who conducted assay for 8 times by involving QC so that %CV of 14.43 was obtained, inter assay accuracy was performed by eight operators who conducted an assay by involving QC to get the result %CV of 14.95¹¹.

The objective of this study is to determine sensitivity, specificity and accuracy of CRRT PSA IRMA kits, using commercial kit as gold standard (IRMA PSA, Izotop kit) which is applied to normal patients among the NNEA employees at the PUSPIPTEK Serpong area.

2. Methods

The material used in this study were monoclonal antibody PSA type M86806 to produce PSA tracer, monoclonal antibody PSA type M66280M to produce coated tube (CT) PSA, a calibrator grade type A01238H to produce a standardised PSA, Na¹²⁵I, chloramine-T, buffer Na₂CO₃ 0.05 M pH 9.6, Bovine Serum Albumine (BSA), commercial IRMA PSA kits (Izotop, Hungary) and other chemicals. Equipment used in the study includes Gamma Management System (GMS), Gamma Mini Assay, micropipette, mixing tool (multimix and vortex), electrophoresis and shaker.

2.1 The production of PSA Tracer

The PSA tracer was made using MAb type M86806M with the amount of 75 μ g/25 μ L placed in the iodination tube, added with 5 μ L of phosphate buffer 0.25 M pH 7.4 and 2 μ L of Na¹²⁵I (activity \pm 1000 μ Ci) and 5 μ L of Chloramine-T (0.5 mg in 1 mL phosphate buffer 0.25 M pH 7.4). Next, the mixture is stirred for about 90 second using vortex. Then 10 μ L of Na₂S₂O₅ solution (0.5 mg Na₂S₂O₅ in 1 mL phosphate buffer 0.25 M pH 7.4) and 100 μ L of KI solution (10 mg KI and 3 mg BSA dissolved in phosphate buffer 0.25 M pH 7.4) were added, after that, the mixture was stirred using vortex for one minute. The result was purified using sephadex G-25 superfine column which had been conditioned with phosphate buffer 0.05 M pH 7.4 and saturated with 1 mL of BSA 5% solution. The anti PSA monoclonal antibody labeled with ¹²⁵I (hereafter

referred to as tracer) was eluted from sephadex G-25 column using buffer solution of phosphate 0.05 M pH 7.4 and the eluate fraction of 500 μ L were collected in the reaction tubes to make 25 fractions. The radioactivity of each eluate fraction was measured by Gamma Mini Assay. The radiochemical purity of the fraction with highest radioactivity was measured using electrophoresis with Whatman 1 paper as so lid phase and barbital buffer 0.05 M pH 8.6 as mobile phase, eluted for one hour at 300 volt, 500 mA .

2.2 The production of PSA antibody monoclonal coated tube

The production of coated tube was carried out using MAb PSA type M66280M and Na_2CO_3 0.05 M pH 9.6. MAb of 250 μ L as a coating solution was put into a starred base tube and incubated overnight at a room temperature (25°C). The initial washing stage was made using buffer solution of Na_2CO_3 0.05 M pH 9.6 containing Tween-20 0.05% resulted in 500 μ L volume. The resulted washing tube was blocked with Na_2CO_3 0.05 M pH 9.6 containing BSA 8% and 0.05% NaN_3 , and then incubated overnight at room temperature (25°C). Then the tube was washed with 500 μ L of buffer containing Tween-20 0.05% once, and dried for 8 hours .

2.3 The production of standardised PSA solution⁹

The concentration of standardized PSA solutions to be prepared were 0, 0.5, 1, 2, 4, 8, 16, 40 and 80 ng/mL. The standardised PSA solution was made using Human PSA calibrator grade (Biosdesign, USA) of 18 μ L dissolved with 20000 μ L of phosphate buffer 0.025 M pH 7.4 containing BSA 5% and 0.1% NaN_3 as the main solution, with the dilution as shown in Table 1.

Table 1. Volume comparison in the production of standardised PSA solution

No	Concentrated standardised PSA solution (ng/mL)	Volume of Human PSA main solution (μ L)	Phosphate Buffer Solution 0.025 M pH 7.4 containing BSA 5% and NaN_3 0.1% (μ L)
1	0	10000	0
2	0.5	5	9995
3	1	10	9990
4	2	20	9980
5	4	40	9960
6	8	80	9920
7	16	160	9840
8	40	400	9600
9	80	800	9200

2.3 Immunology Testing

Eighteen antibody PSA starred based polystyrene reaction tubes (coated tubes, CT) were numbered consecutively (1, 2, 3 etc). A total of 50 μ L of PSA standardised solution of 0, 0.5, 1, 2, 4, 8, 16, 40 and 80 ng/mL are added to the respective coated tube/CT accordingly based on the consecutive numbers, added with 25 μ L of PSA-¹²⁵I with the radioactivity of \approx 50.000 cpm, and then homogenised with vortex, incubated for 18 hours at room temperature by stirring it using a shaker. The liquid was then removed and the CT was washed with 500 μ L of washing buffer once, then decanted and dried. The remaining radioactivity in the tube was measured with GMS for one minute¹⁰.

2.4 Sample testing with the IRMA PSA CRRT

Eighteen antibody PSA starred based polystyrene reaction tubes (coated tubes, CT) were numbered consecutively (1, 2, 3 etc). A total of 50 μ L of PSA standardised solution of 0, 0.5, 1, 2, 4, 8, 16, 40 and 80 ng/mL were added to the respective coated tube/CT accordingly based on the consecutive numbers, added with 25 μ L of PSA-¹²⁵I with the radioactivity of \approx 50.000 cpm, and then homogenised with vortex, incubated for 18 hours at room temperature by stirring it using a shaker. The liquid was then removed and the CT was washed with 500 μ L of washing buffer once, then decanted and dried. The remaining radioactivity in the tube was measured with GMS for one minute¹⁰.

2.5 Sample testing with the Izotop IRMA PSA kit (Hungary)

Eighteen antibody PSA starred based polystyrene reaction tubes (coated tubes, CT) were numbered consecutively (1, 2, 3 etc). A total of 50 μ L of PSA standardised solution of 0, 0.5, 2, 10, 50 ng/mL and control and sample are added respective coated tube/CT accordingly based on the consecutive numbers, added with 200 μ L of PSA-¹²⁵I with the radioactivity of \approx 200.000 cpm, and then homogenised with vortex, incubated for 2 hours at room temperature by stirring it using a shaker. The liquid was then removed and the CT was washed with 1000 μ L of washing buffer once, then decanted and dried. The remaining radioactivity in the tube was measured with GMS for one minute¹⁰.

Table 3. Calculation of sensitivity, specificity and accuracy ^[14]

Comparative Standard Kit			
	+	-	Total
+	a	b	a+b
-	c	d	c+d
Total	a+c	b+d	a+b+c+d

$$\text{Sensitivity} = \frac{a}{a+c} \times 100\%$$

$$\text{Specificity} = \frac{d}{b+d} \times 100\%$$

$$\text{Accuracy} = \frac{a+d}{a+b+c+d} \times 100\%$$

Note :

(+) : positive result; (-) : negative result

a : number of samples which give positive result using both kits (the CRRT and commercial kit)

b : number of samples which give negative result using commercial kits but positive result using the CRRT kit

c : number of samples which give positive result using commercial kits but negative result using the CRRT kit

d : number of samples which give negative result using both kits (the CRRT and commercial kit)

3. Results and discussion

The performance of the CRRT's IRMA free PSA assay was determined using the standardized PSA 0, 0.5, 1, 2, 4, 8, 16, and 80 ng/mL and they are shown results in Fig 1 below.

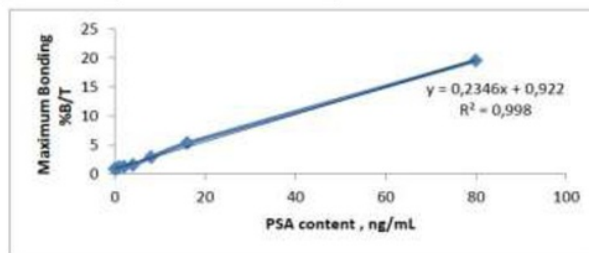

Fig 1. Performance result of the CRRT's IRMA free PSA kit with %NSB of 0.9 and %B/T of 19.57% with value R² 0.998

The result of assay performance obtained has met the good kit requirements since the values of %NSB < 2% and %B/T > 10%.

The calibration curves of the free PSA content measured in normal patients using the CRRT's standardised free PSA and Izotop kits are shown in Fig 1 and Fig 2 respectively.

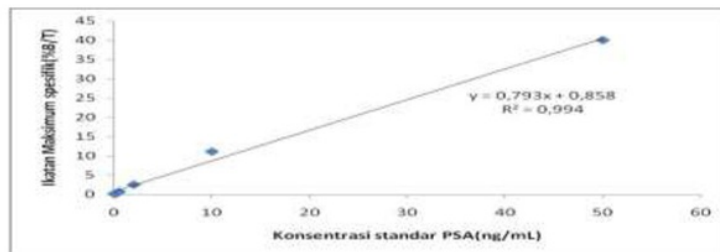

Fig 2. Calibration of the Izotop standardized IRMA PSA kit, with 0.2% NSB and 40.0% B/T

The determination of free PSA content using the CRRT's IRMA free PSA CRRT kit and commercial IRMA free PSA kit (Izotop, Hungary) was applied to 171 samples of the NNEA normal patients at Serpong nuclear area joined by 7 centers consisting the of CRRT (52 persons), Center for Informatica and Nuclear Strategic Zone Utilization, CINSZU (30 persons), Center for Nuclear Fuel Technology, CNFT (25 persons), Center for Nuclear Facilities Engineering, CNFE (23 persons), Radioactive Waste Technology Center, RWTC (18 persons), Center for Multipurpose Reactor, CMPR (12 persons), Center for Nuclear Reactor Technology and Safety, CNRTS (9 persons) and others (13 persons), of males over 40 years old. The blood sample was prepared and tested using the CRRT's IRMA PSA kit (local) and the Izotop IRMA PSA kit (commercial kit) which resulted in 154 negative samples (true negative) meaning normal, two abnormal positive samples (true positive), 15 false negative samples and eight false positive as shown in Table 3. After calculation of data, the sensitivity of

11.67%, specificity of 94.80% and accuracy of 85.96% were obtained. The sensitivity was still low, because the CRRT IRMA PSA kit reading was low compared to Izotop IRMA PSA kit; therefore, 15 samples were read negative although the IRMA PSA Izotop showed positive results in the same samples; consequently, a further study is required to increase sensitivity. The low sensitivity is probably resulted from the instability of the developed IRMA PSA kit component and the decreased efficiency of GMS detector which has been over 10 years old. Hence it might result in the less sensitive readings which lead in a larger significant gap between false positive and false negative. It is therefore necessary to conduct calibration of the existing Gamma counter equipment to make the component more stable.

4. Conclusion

The processed data of the PSA content in normal patients of National Nuclear Energy Agency employees using the CRRT IRMA PSA kit compared to the commercial IRMA PSA kit (Izotop) results in the value of sensitivity 11.76%, specificity 94.80% and accuracy 85.96%. It indicates that the local product conformed with the specification.

Suggestion

It is necessary to conduct further study to increase the stability of the developed IRMA PSA kit and clinical test to determine the free PSA content on the prostate cancer patients and benign prostrate hyperlasia from the hospital. It is also advisable to recount values of normal patients to verify the sensitivity value, and to compare both kits using spearman or Wilcoxon rank test.

Acknowledgements

The writers wish to thank to the staff of the Radioisotope Technology department in providing Na¹²⁵I radioisotope, staffs of the Radiopharmaceuticals Technology department who participated in this research, the paramedics at the National Nuclear Energy Agency policlinic Serpong who have helped take the blood samples, National Nuclear Energy Agency employees who are willing to become volunteers in this study, staff at the Medical Nuclear Technology and Centre for Radiation Safety Technology and Metrology (CRSTM), Radiation Biology department who have helped measure the fPSA contents using the CRRT IRMA PSA kit and Izotop IRMA PSA Hungary kit as well as the Research Advisory Committee of CRRT team that has given some idea to make the study progress as planned. This research was supported by DIPA BATAN No: 080.01.1.450284/2014

References

- Petrus A. Human Physiology and Mechanisms of Disease. p 729-739. Edition III. EGC Medical Publishers book.
- Rediatning W, Sukiyati DJ. Immunoraiometricassay (IRMA) in detection and monitoring of cancer, Journal of Radioisotopes and Radiopharmaceuticals. ,2000. Volume 3, No. 1, pp 55-70.
- Brian Law. Immunoassay A Practical Guide. Taylor & Francis. Publisher since Zaneca. Pharmaceuticals. 1996; page 64-99.
- Karnen GB, Iris R. Basic Immunology. 8th Edition. Faculty of Medicine Universitas Indonesia. Hall Publishers FK UI. Jakarta 2009; p 636.
- "Development of kit for radioimmunoetric assays for tumor markers" Final report of a coordinated research project 1997-2001. IAEA-TECDOC-1307, August, 2002.
- Michael KB. Prostate Specific Antigen. p 1-7, ISBN:0-8247-0555-6.
- Moghadam, AF, Stieber P. *Sensible use of tumour markers*. Edition Roche, Basel, Switzerland. May 1991; p 44-45. ISBN 3-907770-19-6.
- Schmeller N "Clinical value of PSA". 2005; p 14-22. 1st edition, Bremen: UNI-MED. ISBN 3-89599-889-3.
- Puji Widayati, Gina Mondrida, Sri Setiyowati, Agus Ariyanto, Veronika Yuliyanti Susilo, Preparation Reagent Kit Immunoradiometricaassay (IRMA) Prostate Specific Antigen (PSA) to Detect Prostate Cancer. *Journal of Applied Chemistry Indonesia LIPI*. 2013; p 13-2, Vol. 15, No.2, Bandung, December 2013, ISSN : 0853-2788, Accreditation No: 540/AU1/P2MI - LIPI/06/2013.
- Puji Widayati, Sutari, Triningsih, Agus Ariyanto. Optimization Assay Kit Immunoradiometricaassay (IRMA) Prostate Specific Antigen (PSA) For Prostate Cancer Detection, Proceedings of the National Seminar Chemistry. State University of Yogyakarta. p : 77-85, Yogyakarta November 2013, ISBN : 978-602-14548-0-0
- Puji Widayati, Veronika Yuliyanti Susilo, Wening Lestari, Agus ariyanto. Validation Kit Immunoradiometricaassay Free Prostate Specific Antigen For Monitoring Benign Prostate Enlargement in Invitro. 2014; p 65-70, proceedings Scientific Meeting Radioisotopes, Radiopharmaceuticals, Cyclotron and Nuclear Medicine, Hospital Dr Kariadi Training Building, National Nuclear Energy Agency, Center for Radioisotopes and Radiopharmaceuticals Technology Semarang 10 -11 October 2014. ISSN : 2087-9652.
- Mohammed A Virji, Donald W Mercer, Ronald B Herberman, CA: A Cancer Journal for Clinicians, Tumor Markers in Cancer Diagnostic and Prognosis. 1998; 38 p 104-126.
- Syahril, Diagnostic & Screening, Part of Pediatrics, Faculty of Medicine, University of North Sumatra, p: 1-7.
- Rajul Parikh, Annie Mathai, Shevali Parikh, G Chandra Sekhar, Ravi Thomas. Understanding and using sensitivity, specificity and predictive values. *Indian Journal of Ophthalmology*. 2008 Jan-Feb; 58(1): 45-50.
- SV Siregar. Prevalence of Prostate Cancer in Laboratory of Pathology, Faculty of Medicine University of North Sumatra, 2009-2010 Thesis 2011.
- D Erlangga N, Diagnostic accuracy of Prostate Specific Antigen In Prostate Malignancy in Kariadi Doctors Hospital, Faculty of Medicine, University of Diponegoro, Semarang 2007.
- <http://www.izotop.hu>, Free PSA ¹²⁵I IRMA Kit, RK-85CTA101213.

Analyze Activation Marker of Azurophilic Granule (CD63) and CFSE CD11C Expressions of Salivary Neutrophils Insevere Early Childhood Caries.

ORIGINALITY REPORT

20%

SIMILARITY INDEX

16%

INTERNET SOURCES

15%

PUBLICATIONS

8%

STUDENT PAPERS

PRIMARY SOURCES

1

buy.micorella.org

Internet Source

<1%

2

medind.nic.in

Internet Source

<1%

3

www.bioinformation.net

Internet Source

<1%

4

Md. Akil Hossain, Seung-Jin Lee, Na-Hye Park, Abraham Fikru Mechesso et al. "Impact of phenolic compounds in the acyl homoserine lactone-mediated quorum sensing regulatory pathways", Scientific Reports, 2017

Publication

<1%

5

Submitted to University of Baghdad

Student Paper

<1%

6

Khalit Mohamad, Yusuke Hirasawa, Marc Litaudon, Khalijah Awang et al. "Ceramicines B–D, new antiplasmodial limonoids from

<1%

Chisocheton ceramicus", Bioorganic & Medicinal Chemistry, 2009

Publication

7	"Encyclopedia of Cancer", Springer Nature, 2017 Publication	<1%
8	repository.ugm.ac.id Internet Source	<1%
9	www.cyto.purdue.edu Internet Source	<1%
10	my.chemeng.queensu.ca Internet Source	<1%
11	Abu-Dief, Ahmed M., Ibrahim F. Nassar, and Wafaa H. Elsayed. "Magnetic NiFe ₂ O ₄ nanoparticles: efficient, heterogeneous and reusable catalyst for synthesis of acetylferrocene chalcones and their anti-tumour activity : NiFe ₂ O ₄ nanoparticles for synthesis of acetylferrocene chalcones", Applied Organometallic Chemistry, 2016. Publication	<1%
12	ijiset.com Internet Source	<1%
13	adln.lib.unair.ac.id Internet Source	<1%

14	surfer.pan.wroc.pl Internet Source	<1%
15	Yang, S.F.. "Antimetastatic potentials of flavones on oral cancer cell via an inhibition of matrix-degrading proteases", Archives of Oral Biology, 200803 Publication	<1%
16	ojs.unud.ac.id Internet Source	<1%
17	inventi.in Internet Source	<1%
18	iji.ir Internet Source	<1%
19	K. Inouye. "Comparison of the Thermal Stabilities of Reverse Transcriptases from Avian Myeloblastosis Virus and Moloney Murine Leukaemia Virus", Journal of Biochemistry, 11/04/2007 Publication	<1%
20	mycosphere.org Internet Source	<1%
21	Submitted to Petroleum Research & Development Center Student Paper	<1%
22	vandvdevelopments.com	

<1%

23

Gayathri Ramasubban, Kulandai Lily Therese, Umashankar Vetrivel, Muthukumaran Sivashanmugam et al. "Detection of novel coupled mutations in the katG gene (His276Met, Gln295His and Ser315Thr) in a multidrug-resistant Mycobacterium tuberculosis strain from Chennai, India, and insight into the molecular mechanism of isoniazid resistance using structural bioinformatics approaches", International Journal of Antimicrobial Agents, 2011

Publication

<1%

24

ir.uiowa.edu

Internet Source

<1%

25

gredos.usal.es

Internet Source

<1%

26

marte3.sid.inpe.br

Internet Source

<1%

27

biomaterial-lipi.org

Internet Source

<1%

28

Utama, Andi. "Hepatitis B virus subgenotypes and basal core promoter mutations in Indonesia", World Journal of Gastroenterology, 2009.

<1%

29 www.formatex.info <1 %
Internet Source

30 bentham.org <1 %
Internet Source

31 cellsignal.eu <1 %
Internet Source

32 www.indexintelligence.org <1 %
Internet Source

33 theses.uin-malang.ac.id <1 %
Internet Source

34 wilresearch.com <1 %
Internet Source

35 ajtmh.org <1 %
Internet Source

36 Ostridge, Kristoffer, Nicholas Williams, Viktoriya Kim, Stephen Harden, Simon Bourne, Ngaire A. Coombs, Paul T. Elkington, Raul San Jose Estepar, George Washko, Karl J. Staples, and Tom M. A. Wilkinson. "Distinct emphysema subtypes defined by quantitative CT analysis are associated with specific pulmonary matrix metalloproteinases", Respiratory Research, 2016.
Publication

- | | | |
|----|--|-----|
| 37 | Sajal Chakraborti, Jaganmay Sarkar, Pijush Kanti Pramanik, Tapati Chakraborti. "Chapter 16 Role of Proteases in Lung Disease: A Brief Overview", Springer Nature, 2017
Publication | <1% |
| 38 | aij.batan.go.id
Internet Source | <1% |
| 39 | herbalgram.com
Internet Source | <1% |
| 40 | ftp.iza.org
Internet Source | <1% |
| 41 | Crispim, Myuki Alfaia, Nelson Fraiji, Sonia Campello, Nicolaus Schriefer, Mariane Martins Stefani, and Dagmar Kiesslich. "Molecular epidemiology of hepatitis B and hepatitis delta viruses circulating in the Western Amazon region, North Brazil", BMC Infectious Diseases, 2014.
Publication | <1% |
| 42 | intl.jbc.org
Internet Source | <1% |
| 43 | www.scitechnol.com
Internet Source | <1% |
| 44 | Gálvez, Marina, Carmen Martín-Cordero, Peter J. Houghton, and María Jesús Ayuso. | <1% |

"Antioxidant Activity of Methanol Extracts Obtained from *Plantago* Species", Journal of Agricultural and Food Chemistry, 2005.

Publication

45

Submitted to CSU, San Jose State University

Student Paper

<1%

46

www.cancer.org

Internet Source

<1%

47

jocpr.com

Internet Source

<1%

48

www.jmedicalcasereports.com

Internet Source

<1%

49

Gu, Chao, Yaqing Li, Wu-Lin Xu, Jian-Ping Yan, Ying-jie Xia, Ying-Yu Ma, Chun Chen, Hui-Ju Wang, and Hou-quan Tao. "Sirtuin 1 Activator SRT1720 Protects Against Lung Injury via Reduction of Type II Alveolar Epithelial Cells Apoptosis in Emphysema", COPD Journal of Chronic Obstructive Pulmonary Disease, 2015.

Publication

<1%

50

Submitted to UC, San Diego

Student Paper

<1%

51

www.aacijournal.com

Internet Source

<1%

52	medwelljournals.net Internet Source	<1%
53	espace.curtin.edu.au Internet Source	<1%
54	research.ijcaonline.org Internet Source	<1%
55	www.wjso.com Internet Source	<1%
56	www.icpo.org.in Internet Source	<1%
57	www.searo.who.int Internet Source	<1%
58	usab-tm.ro Internet Source	<1%
59	top25.sciencedirect.com Internet Source	<1%
60	O'Prey, J.. "Effects of dietary flavonoids on major signal transduction pathways in human epithelial cells", <i>Biochemical Pharmacology</i> , 20031201 Publication	<1%
61	bdspinet.bdsp.tm.fr Internet Source	<1%

Lu, Fachuang, Steven D. Karlen, Matt Regner,

62

Hoon Kim, Sally A. Ralph, Run-Cang Sun, Ken-ichi Kuroda, Mary Ann Augustin, Raymond Mawson, Henry Sabarez, Tanoj Singh, Gerardo Jimenez-Monteon, Sarani Zakaria, Stefan Hill, Philip J. Harris, Wout Boerjan, Curtis G. Wilkerson, Shawn D. Mansfield, and John Ralph. "Naturally p-Hydroxybenzoylated Lignins in Palms", BioEnergy Research, 2015.

Publication

<1%

63

fatihkocabas.net

Internet Source

<1%

64

epicentre.massey.ac.nz

Internet Source

<1%

65

David Y. Graham, Muhammad Miftahussurur. "Helicobacter pylori urease for diagnosis of Helicobacter pylori infection: A mini review", Journal of Advanced Research, 2018

Publication

<1%

66

ijcc.iregway.com

Internet Source

<1%

67

medicine.buffalo.edu

Internet Source

<1%

68

Da-wei Wang, Sheng-yuan Yu, Yang Cao, Lei Yang, Wei Liu, Xiao-qiang Er, Gui-jun Yao, Zheng-gang Bi. "Identification of CD20, ECM, and ITGA as Biomarkers for Osteosarcoma by

<1%

Integrating Transcriptome Analysis", Medical Science Monitor, 2016

Publication

69

ŞANAL, Laser. "Kan Donörlerinde HBsAg, anti-HCV ve anti-HIV seroprevelansı: 6 yıllık bir çalışma", Orttadoğu Reklam ve Yayıncılık A.Ş., 2016.

Publication

<1%

70

Submitted to Universitas Muhammadiyah Surakarta

Student Paper

<1%

71

Topakas, E.. "Microbial production, characterization and applications of feruloyl esterases", Process Biochemistry, 200704

Publication

<1%

72

abeetle.tripod.com

Internet Source

<1%

73

www.uece.br

Internet Source

<1%

74

print.ispub.com

Internet Source

<1%

75

www.path.org

Internet Source

<1%

76

David T. Gauthier. "Bacterial zoonoses of fishes: A review and appraisal of evidence for linkages between fish and human infections",

<1%

The Veterinary Journal, 2015

Publication

77	cgspace.cgiar.org Internet Source	<1%
78	penelitian.unair.ac.id Internet Source	<1%
79	Submitted to Jawaharlal Nehru University (JNU) Student Paper	<1%
80	nv-cpc.org Internet Source	<1%
81	horizon.documentation.ird.fr Internet Source	<1%
82	Vamanu, Emanuel. "In Vitro Antimicrobial and Antioxidant Activities of Ethanolic Extract of Lyophilized Mycelium of Pleurotus ostreatus PQMZ91109", <i>Molecules</i> , 2012. Publication	<1%
83	tci-thaijo.org Internet Source	<1%
84	repositorio.ufpe.br Internet Source	<1%
85	publications.lib.chalmers.se Internet Source	<1%

elib.pdii.lipi.go.id

86

Internet Source

<1%

87

www.europarmagenics.com

Internet Source

<1%

88

arno.unimaas.nl

Internet Source

<1%

89

ndt.oxfordjournals.org

Internet Source

<1%

90

aac.highwire.org

Internet Source

<1%

91

antiox.org

Internet Source

<1%

92

Rini Jarial, Sveta Thakur, Mimi Sakinah, A.W. Zularisam, Amit Sharad, S.S. Kanwar, Lakhveer Singh. "Potent anticancer, antioxidant and antibacterial activities of isolated flavonoids from *Asplenium nidus*", Journal of King Saud University - Science, 2016

Publication

<1%

93

www.thesis.uchile.cl

Internet Source

<1%

94

www.ijcmr.com

Internet Source

<1%

95

www.nantes.inra.fr

Internet Source

<1%

96 Sun, , J. M. Fang, J. Tomkinson, and J. Bolton. <1%
"Physicochemical and Structural
Characterization of Alkali Soluble Lignins from
Oil Palm Trunk and Empty Fruit-Bunch Fibers",
Journal of Agricultural and Food Chemistry,
1999.
Publication

97 www.matec-conferences.org <1%
Internet Source

98 liu.diva-portal.org <1%
Internet Source

99 Iriawati, Andira Rahmawati, Rizkita R. Esyanti. <1%
"Analysis of Secondary Metabolite Production
in Somatic Embryo of Pasak Bumi (Eurycoma
Longifolia Jack.)", Procedia Chemistry, 2014
Publication

100 id.portalgaruda.org <1%
Internet Source

101 Saluk-Juszczak, J.. "(1->3)-@b-d-Glucan <1%
inhibits a dual mechanism of peroxynitrite
stroke", International Journal of Biological
Macromolecules, 20110401
Publication

102 Özcan, K., H. Özen, and M. Karaman. <1%
"Nitrosative tissue damage and apoptotic cell
death in kidneys and livers of naturally

ethylene glycol (antifreeze)-poisoned geese",
Avian Pathology, 2007.

Publication

103

excli.de

Internet Source

<1%

104

Tapper, H.. "Neutrophil elastase sorting involves plasma membrane trafficking requiring the C-terminal propeptide", Experimental Cell Research, 20061101

Publication

<1%

105

Marietto-Gonçalves, GA, Curotto SMR, AAS Baptista, TC Donato, RK Takahira, JL Sequeira, and RL Andreatti Filho. "Effects of Lactobacillus Probiotic, P22 Bacteriophage and Salmonella Typhimurium on the Heterophilic Burst Activity of Broiler Chickens", Revista Brasileira de Ciência Avícola, 2014.

Publication

<1%

106

www.idjsr.com

Internet Source

<1%

107

A Putranti, T P Asmarawati, B E Rachman, U Hadi, Nasronudin. "Oral candidiasis as clinical manifestation of HIV/AIDS infection in Airlangga University hospital patients", IOP Conference Series: Earth and Environmental Science, 2018

Publication

<1%

108	www.portalgaruda.org Internet Source	<1%
109	www.tm.mahidol.ac.th Internet Source	<1%
110	Ruthanne S. McCoy, Sam Choi, George Collins, Bruce J. Ackerson, Christopher J. Ackerson. "Superatom Paramagnetism Enables Gold Nanocluster Heating in Applied Radiofrequency Fields", ACS Nano, 2013 Publication	<1%
111	Wong, Sissie, Maria G Belvisi, and Mark A Birrell. "MMP/TIMP expression profiles in distinct lung disease models: implications for possible future therapies", Respiratory Research, 2009. Publication	<1%
112	S. G. Sarafianos. "Lamivudine (3TC) resistance in HIV-1 reverse transcriptase involves steric hindrance with beta -branched amino acids", Proceedings of the National Academy of Sciences, 08/31/1999 Publication	<1%
113	www.sdiarticle1.org Internet Source	<1%
114	www.abdn.ac.uk Internet Source	<1%

115	www.molvis.org Internet Source	<1%
116	A. Calascibetta. "Analysis of the Thymidylate Synthase Gene Structure in Colorectal Cancer Patients and Its Possible Relation with the 5-Fluorouracil Drug Response", Journal of Nucleic Acids, 2010 Publication	<1%
117	www.palgraveconnect.com Internet Source	<1%
118	"Association of Candida with Linear Gingival Erythema in HIV-Infected Subjects", Oral Candidosis, 2015. Publication	<1%
119	Walton, N.J.. "Novel approaches to the biosynthesis of vanillin", Current Opinion in Biotechnology, 20001001 Publication	<1%
120	Conde, M.. "Analysis of IgG response to experimental infection with RH Toxoplasma gondii in goats", Comparative Immunology, Microbiology and Infectious Diseases, 200107 Publication	<1%
121	Cai, Daozhang. "Mitochondrial genome sequencing of chondrocytes in osteoarthritis by Human Mitochondria RT2 Profiler [®] , _ç PCR	<1%

- 122 N. A. Margot. "In Vitro Human Immunodeficiency Virus Type 1 Resistance Selections with Combinations of Tenofovir and Emtricitabine or Abacavir and Lamivudine", Antimicrobial Agents and Chemotherapy, 10/02/2006 <1%
Publication
-

- 123 ijpsr.com <1%
Internet Source
-

- 124 van der Kuyl, Antoinette C, Fokla Zorgdrager, Boris Hogema, Margreet Bakker, Suzanne Jurriaans, Nicole KT Back, Ben Berkhout, Hans L Zaaijer, and Marion Cornelissen. "High prevalence of hepatitis B virus dual infection with genotypes A and G in HIV-1 infected men in Amsterdam, the Netherlands, during 2000-2011", BMC Infectious Diseases, 2013. <1%
Publication
-

- 125 Boostani, A, H R Mahmoodian Fard, A Ashayerizadeh, and M Aminafshar. "Growth performance, carcass yield and intestinal microflora populations of broilers fed diets containing thepax and yogurt", Revista Brasileira de Ciência Avícola, 2013. <1%
Publication
-

126	ml.scribd.com Internet Source	<1%
127	Estelle Bonnin. "Enhanced bioconversion of vanillic acid into vanillin by the use of 'natural' cellobiose", <i>Journal of the Science of Food and Agriculture</i> , 03/01/1999 Publication	<1%
128	Manoj Kumar Narasimhan, Shenoy K Pavithra, Vishnupriya Krishnan, Muthukumaran Chandrasekaran. "In vitro Analysis of Antioxidant, Antimicrobial and Antiproliferative Activity of <i>Enteromorpha antenna</i> , <i>Enteromorpha linza</i> and <i>Gracilaria corticata</i> Extracts", <i>Jundishapur Journal of Natural Pharmaceutical Products</i> , 2013 Publication	<1%
129	www.mednet.gr Internet Source	<1%
130	jurnalrespirologi.org Internet Source	<1%
131	www.cropscience.jp Internet Source	<1%
132	lib.bioinfo.pl Internet Source	<1%
133	cjcjournal.biomedcentral.com Internet Source	<1%

134 www.virochempharma.com <1 %
Internet Source

135 Pienaar, Elizabeth D, Taryn Young, Haly Holmes, and Elizabeth D Pienaar. <1 %
"Interventions for the prevention and management of oropharyngeal candidiasis associated with HIV infection in adults and children", Cochrane Database of Systematic Reviews, 2010.
Publication

136 Camera-Roda, Giovanni, Antonio Cardillo, Vittorio Loddo, Leonardo Palmisano, and Francesco Parrino. <1 %
"Improvement of Membrane Performances to Enhance the Yield of Vanillin in a Pervaporation Reactor", Membranes, 2014.
Publication

137 Ali, Naeem, Sameen Yousaf, Maira Anam, Zain Bangash, and Sehrish Maleeha. <1 %
"Evaluating the efficiency of mixed culture biofilm for the treatment of black liquor and molasses in mediator less microbial fuel cell", Environmental Technology, 2016.
Publication

138 "New Findings on HIV/AIDS and Genetics Described by Investigators at Kobe University Graduate School ", AIDS Weekly, March 9 2015 <1 %

Issue

Publication

139	perspectivesinmedicine.org Internet Source	<1%
140	www.ijpcs.net Internet Source	<1%
141	jnci.oxfordjournals.org Internet Source	<1%
142	Brechot, C.. "Genetic variation of the hepatitis C virus (HCV) genome: random events or a clinically relevant issue?", <i>Journal of Hepatology</i> , 1993 Publication	<1%
143	www.tonu.org Internet Source	<1%
144	Eduarda Gomes-Neves, Patrícia Antunes, Alcina Tavares, Patrícia Themudo et al. "Salmonella cross-contamination in swine abattoirs in Portugal: Carcasses, meat and meat handlers", <i>International Journal of Food Microbiology</i> , 2012 Publication	<1%
145	hdr.undp.org Internet Source	<1%
146	S. Seng. "Expression of SAG -1 of <i>Toxoplasma</i>	<1%

gondii in transgenic mice", Parasitology
Research, 03/17/2000

Publication

-
- | | | |
|-----|---|-----|
| 147 | www.ad-astra.ro
Internet Source | <1% |
|-----|---|-----|
-
- | | | |
|-----|---|-----|
| 148 | treathiv.com
Internet Source | <1% |
|-----|---|-----|
-
- | | | |
|-----|---|-----|
| 149 | www.stks.or.th
Internet Source | <1% |
|-----|---|-----|
-
- | | | |
|-----|---|-----|
| 150 | atvb.ahajournals.org
Internet Source | <1% |
|-----|---|-----|
-
- | | | |
|-----|---|-----|
| 151 | Sakine Yalçın. "Effects of dietary yeast autolysate (<i>Saccharomyces cerevisiae</i>) on performance, egg traits, egg cholesterol content, egg yolk fatty acid composition and humoral immune response of laying hens", <i>Journal of the Science of Food and Agriculture</i> , 2010
Publication | <1% |
|-----|---|-----|
-
- | | | |
|-----|---|-----|
| 152 | www.palgrave-journals.com
Internet Source | <1% |
|-----|---|-----|
-
- | | | |
|-----|---|-----|
| 153 | www.bimkes.org
Internet Source | <1% |
|-----|---|-----|
-
- | | | |
|-----|--|-----|
| 154 | Helen Ilumets. "Ageing and smoking contribute to plasma surfactant proteins and protease | <1% |
|-----|--|-----|

imbalance with correlations to airway obstruction", BMC Pulmonary Medicine, 2011

Publication

155

Submitted to Saint Leo University

Student Paper

<1%

156

Liao, Wenzhen, Zhengxiang Ning, Luying Chen, Qingyi Wei, Erdong Yuan, Jiguo Yang, and Jiaoyan Ren. "Intracellular Antioxidant Detoxifying Effects of Diosmetin on 2,2-Azobis(2-amidinopropane) Dihydrochloride (AAPH)-Induced Oxidative Stress through Inhibition of Reactive Oxygen Species Generation", Journal of Agricultural and Food Chemistry

Publication

<1%

157

Ahmed Y. Coulibaly. "Antioxidant and Anti-Inflammatory Effects of *Scoparia dulcis* L.", Journal of Medicinal Food, 08/26/2011

Publication

<1%

158

Zeković, Djordje B., Stefan Kwiatkowski, Miroslav M. Vrvić, Dragica Jakovljević, and Colm A. Moran. "Natural and Modified (1→3)-β-D-Glucans in Health Promotion and Disease Alleviation", Critical Reviews in Biotechnology, 2005.

Publication

<1%

159

www.alpron.co.jp

<1%

160

A Roosdiana, S A Yudandi, A Erika. " The Potency of Ethanolic Extract of (L.) Merr Leaves as Therapeutic herbal of Rats Peptic Ulcer Model Induced by Aspirin ", IOP Conference Series: Materials Science and Engineering, 2018

Publication

<1%

161

herbapolonica.pl

Internet Source

<1%

162

brc.pbrc.edu

Internet Source

<1%

163

www.jidc.org

Internet Source

<1%

164

jpma.org.pk

Internet Source

<1%

165

Moraes, M.T.B., C. Niel, and S.A. Gomes. "A polymerase chain reaction-based assay to identify genotype F of hepatitis B virus", Brazilian Journal of Medical and Biological Research, 1999.

Publication

<1%

166

Marcus Vinícius Coutinho Cossi. "Destructive and Nondestructive Procedures to Obtain

<1%

Chicken Carcass Samples for *Escherichia coli* and *Salmonella* spp. Detection", Foodborne Pathogens and Disease, 08/21/2011

Publication

-
- 167 Gong, Lingxiao, Luolian Huang, and Ying Zhang. "Effect of Steam Explosion Treatment on Barley Bran Phenolic Compounds and Antioxidant Capacity", Journal of Agricultural and Food Chemistry, 2012. <1%
- Publication
-
- 168 policy-csimpp.gmu.edu <1%
- Internet Source
-
- 169 Mendez-Vilas, A. "Analysis of the 2-Phenylethyl isothiocyanate present in Brassica leaves and their potential application as antimicrobial agent against bacteria strains isolated from Human and Pig gastrointestinal tracts", Science and Technology Against Microbial Pathogens, 2011. <1%
- Publication
-
- 170 repository.wima.ac.id <1%
- Internet Source
-
- 171 journal.ugm.ac.id <1%
- Internet Source
-
- 172 C. Sukasem. "Surveillance of Genotypic Resistance Mutations in Chronic HIV-1 Treated <1%

Individuals After Completion of the National
Access to Antiretroviral Program in Thailand",
Infection, 04/2007

Publication

173 Tzu-Tai Lee, Jhih-Ying Ciou, Ching-Jen Chiang, Yun-Peng Chao, Bi Yu. "Effect of Pleurotus eryngii Stalk Residue on the Oxidative Status and Meat Quality of Broiler Chickens", Journal of Agricultural and Food Chemistry, 2012

Publication

174 NWANKWO, Emmanuel, MOMODU, Imoru, UMAR, Ismaila, MUSA, Babashani and ADELEKE, Solomon. "Seroprevalence of major blood-borne infections among blood donors in Kano, Nigeria", TÜBİTAK, 2012.

Publication

175 icmr.nic.in

Internet Source

176 academic.mintel.com

Internet Source

177 pediatrics.aappublications.org

Internet Source

178 eprints.lincoln.ac.uk

Internet Source

179 A. Churg. "Matrix metalloproteinases in COPD",

180

"The 21st Conference of the Asian Pacific Association for the Study of the Liver : Oral Presentations 17 February, 2011 (Thursday)", *Hepatology International*, 03/2011

Publication

<1%

181

Su, Xun-Cheng, Yao Wang, Hiromasa Yagi, Dmitry Shishmarev, Claire E. Mason, Paul J. Smith, Marylène Vandevenne, Nicholas E. Dixon, and Gottfried Otting. "Bound or Free: Interaction of the C-Terminal Domain of Escherichia coli Single-Stranded DNA-Binding Protein (SSB) with the Tetrameric Core of SSB", *Biochemistry*, 2014.

Publication

<1%

182

Leema, George, Arumugam Ramachandran Muralidharan, Thangaraj Annadurai, Jayaraman Kaliamurthy, Pitchairaj Geraldine, and Philip A. Thomas. "Oxidative Stress in Experimental Rodent Corneas Infected With Aflatoxigenic and Nonaflatoxigenic *Aspergillus flavus* :", *Cornea*, 2013.

Publication

<1%

183

Dong Young Rhyu. "Active Compounds Isolated from Traditional Chinese Prescription Wen-Pi-Tang Protecting Against Peroxynitrite-Induced

<1%

LLC-PK1 Cell Damage", The American Journal
of Chinese Medicine, 2008

Publication

184	www.jbpr.in Internet Source	<1%
185	Submitted to Brunel University Student Paper	<1%
186	www.tdaxp.com Internet Source	<1%
187	Submitted to Chiang Mai University Student Paper	<1%
188	D Khalafkhany, M Makvandi, D Javanmard, M Hamidi-Fard, AR Samarbaf-Zadeh. "Determination of Hepatitis Delta Virus Genotype among HBV Carriers in Southwest of Iran", Iranian Journal of Virology, 2012 Publication	<1%
189	pgsskroton.com.br Internet Source	<1%
190	japsonline.com Internet Source	<1%
191	cnrtoxoplasmosse.chu-reims.fr Internet Source	<1%
192	Pi-Fen Wei. "The investigation of glutathione peroxidase, lactoferrin, myeloperoxidase and	<1%

interleukin-1beta in gingival crevicular fluid: implications for oxidative stress in human periodontal diseases", Journal of Periodontal Research, 10/2004

Publication

193

espace.library.uq.edu.au

Internet Source

<1%

194

www.naturalscience.co.za

Internet Source

<1%

195

Stephen Quan, Piyush Kumar, Ravin Narain. "Cationic Galactose-Conjugated Copolymers for Epidermal Growth Factor (EGFR) Knockdown in Cervical Adenocarcinoma", ACS Biomaterials Science & Engineering, 2016

Publication

<1%

196

Nisarg R Desai. "Choriocarcinoma in a 73-year-old woman: a case report and review of the literature", Journal of Medical Case Reports, 2010

Publication

<1%

197

dentistry.tbzmed.ac.ir

Internet Source

<1%

198

www.doria.fi

Internet Source

<1%

199

www.ijph.it

Internet Source

<1%

200	www.jnda.com.np Internet Source	<1%
201	www.microbio.uab.edu Internet Source	<1%
202	N Nwankwo, H Seker. "A signal processing-based Bioinformatics approach to assessing drug resistance: Human Immunodeficiency Virus as a case study", 2010 Annual International Conference of the IEEE Engineering in Medicine and Biology, 2010 Publication	<1%
203	Benediktus Yohan, Puspa Wardhani, Aryati, Hidayat Trimarsanto, R. Tedjo Sasmono. "Production of recombinant dengue non-structural 1 (NS1) proteins from clinical virus isolates", Protein Expression and Purification, 2017 Publication	<1%
204	De Marino, Simona, Nicola Borbone, Franco Zollo, Angela Ianaro, Paola Di Meglio, and Maria Iorizzi. "Megastigmane and Phenolic Components from <i>Laurus nobilis</i> L. Leaves and Their Inhibitory Effects on Nitric Oxide Production", Journal of Agricultural and Food Chemistry, 2004. Publication	<1%

Saha, Sarmistha, and Ramtej J. Verma.

205	"Ethylene glycol induced renal toxicity in female Wistar rats", Toxicology and Environmental Health Sciences, 2013.	<1%
Publication		
206	www.experts.scival.com	<1%
Internet Source		
207	breast-cancer-research.com	<1%
Internet Source		
208	Lacy, Paige. "Mechanisms of Degranulation in Neutrophils", Allergy Asthma & Clinical Immunology, 2006.	<1%
Publication		
209	www.biolreprod.org	<1%
Internet Source		
210	profdoc.um.ac.ir	<1%
Internet Source		
211	Anak Agung Istri Ratnadewi, Wuryanti Handayani, Ika Oktavianawati, Agung Budi Santoso, Ni Nyoman Tri Puspaningsih. "Isolation and Hydrolysis Xylan from Soybean Waste with Endo- β -1,4-D-Xylanase of Bacillus sp. From Soil Termite Abdomen", Agriculture and Agricultural Science Procedia, 2016	<1%
Publication		
212	Submitted to Univerza v Ljubljani	<1%
Student Paper		

213	Nur Rizal, Mohamad Ibrahim, Mohd Zakaria, Suraini Abd-Aziz, Phang Yee, Mohd Hassan. "Pre-treatment of Oil Palm Biomass for Fermentable Sugars Production", <i>Molecules</i> , 2018	<1%
Publication		
214	repositorio.ufsm.br	<1%
Internet Source		
215	Submitted to Queen's University of Belfast	<1%
Student Paper		
216	Yancheva, Svetla, Petros MAVROMATIS, and Lidiya GEORGIEVA. "Polyphenol profile and antioxidant activity of extracts from olive leaves", <i>Journal of Central European Agriculture</i> , 2016.	<1%
Publication		
217	www.google.it	<1%
Internet Source		
218	Lung Inflammation, 2014.	<1%
Publication		
219	Submitted to Yonsei University	<1%
Student Paper		
220	Ângelo Luís, Andreia Duarte, Jorge Gominho, Fernanda Domingues, Ana Paula Duarte. "Chemical composition, antioxidant, antibacterial and anti-quorum sensing activities	<1%

of Eucalyptus globulus and Eucalyptus radiata essential oils", Industrial Crops and Products, 2016

Publication

221

CAPPELLE, J., A. CARON, R. SERVAN De ALMEIDA, P. GIL, M. PEDRONO, J. MUNDAVA, B. FOFANA, G. BALANÇA, M. DAKOUO, A. B. OULD EL MAMY, C. ABOLNIK, O. F. MAMINIAINA, G. S. CUMMING, M.-N. De VISSCHER, E. ALBINA, V. CHEVALIER, and N. GAIDET. "Empirical analysis suggests continuous and homogeneous circulation of Newcastle disease virus in a wide range of wild bird species in Africa", Epidemiology and Infection, 2014.

Publication

222

doiserbia.nb.rs

Internet Source

223

Zhao, Yan, JianLi GAO, JianWei Ji, Min Gao, QiaoShan Yin, QiaoLi Qiu, Chuan Wang, ShuZhan Chen, Juan Xu, RenShang Liang, YanZi Cai, and XiaFei Wang. "Cytotoxicity enhancement in MDA-MB-231 cells by the combination treatment of tetrahydropalmatine and berberine derived from Corydalis yanhusuo W. T. Wang", Journal of Intercultural Ethnopharmacology, 2014.

Publication

<1%

<1%

<1%

224	www.ijrcog.org Internet Source	<1%
225	Luciane T. Cunha. "Effect of Prototheca zopfii on neutrophil function from bovine milk", Mycopathologia, 12/2006 Publication	<1%
226	Submitted to University of Adelaide Student Paper	<1%
227	Submitted to M.M. International School, Mullana Student Paper	<1%
228	67.207.206.99 Internet Source	<1%
229	www.oralhealth.ro Internet Source	<1%
230	shareok.org Internet Source	<1%
231	Management of Microbial Resources in the Environment, 2013. Publication	<1%
232	www.diva-portal.org Internet Source	<1%
233	Silke C. Jaehrig, Sascha Rohn, Lothar W. Kroh, Franz X. Wildenauer, Fred Lisdat, Lutz-Guenther Fleischer, Tomas Kurz. "Antioxidative	<1%

activity of (1→3), (1→6)-β-d-glucan from
Saccharomyces cerevisiae grown on different
media", LWT - Food Science and Technology,
2008

Publication

234

210.75.237.14

Internet Source

<1%

235

jurnal.fkip.uns.ac.id

Internet Source

<1%

236

N Castro. "Characterization of Edwardsiella
tarda strains isolated from turbot, Psetta
maxima (L.)", Journal of Fish Diseases, 9/2006

Publication

237

Y.-M. Wang. "Genetic relationships of
Edwardsiella strains isolated in China
aquaculture revealed by rep-PCR genomic
fingerprinting and investigation of Edwardsiella
virulence genes : Genotyping of Edwardsiella
strains", Journal of Applied Microbiology,
12/2011

Publication

238

atgenglobal.com

Internet Source

<1%

239

"Regulation of immune responses by
neutrophils : Regulation of immune responses
by neutrophils", Annals of the New York

<1%

Academy of Sciences, 2014.

Publication

-
- | | | |
|-----|--|-----|
| 240 | Cappiello, Joyce, and Julie Bosak. "IUDs : Beyond the basics", <i>The Nurse Practitioner</i> , 2013.
Publication | <1% |
| 241 | <i>Health of Antarctic Wildlife</i> , 2009.
Publication | <1% |
| 242 | 211.144.68.84:9998
Internet Source | <1% |
| 243 | www.plospathogens.org
Internet Source | <1% |
| 244 | knowledgecommons.lakeheadu.ca
Internet Source | <1% |
| 245 | Submitted to Clarkson University
Student Paper | <1% |
| 246 | www.hkam.org.hk
Internet Source | <1% |
| 247 | www.rombio.eu
Internet Source | <1% |
| 248 | Alessandro Buriani, Stefano Fortinguerra, Vincenzo Sorrenti, Stefano Dall'Acqua et al. "Human Adenocarcinoma Cell Line Sensitivity to Essential Oil Phytocomplexes from Pistacia Species: a Multivariate Approach", <i>Molecules</i> , | <1% |

2017

Publication

-
- | | | |
|-----|--|-----|
| 249 | Submitted to Rider University
Student Paper | <1% |
|-----|--|-----|
-
- | | | |
|-----|---|-----|
| 250 | www.avepa.org
Internet Source | <1% |
|-----|---|-----|
-
- | | | |
|-----|---|-----|
| 251 | "Investigators at Ohio State University, College of Pharmacy zero in on drug development.",
Biotech Week, March 31 2010 Issue
Publication | <1% |
|-----|---|-----|
-
- | | | |
|-----|---|-----|
| 252 | Sterzo, EV, JB Paiva, AL Mesquita, OC Freitas Neto, and A Berchieri Jr. "Organic acids and/or compound with defined microorganisms to control Salmonella enterica serovar Enteritidis experimental infection in chickens", Revista Brasileira de CiÃªncia AvÃcola, 2007.
Publication | <1% |
|-----|---|-----|
-
- | | | |
|-----|---|-----|
| 253 | jamc.ayubmed.edu.pk
Internet Source | <1% |
|-----|---|-----|
-
- | | | |
|-----|--|-----|
| 254 | Renata E.F. Macedo, Fernando B. Luciano, Roniele P. Cordeiro, Chibuike C. Udenigwe. "Sausages and other fermented meat products", Wiley, 2017
Publication | <1% |
|-----|--|-----|
-
- | | | |
|-----|---------------------------------------|-----|
| 255 | 211.155.251.135:81
Internet Source | <1% |
|-----|---------------------------------------|-----|
-

256

cdn.aphca.org

Internet Source

<1%

257

Yu-Loong Loow, Ta Yeong Wu, Khang Aik Tan, Yung Shen Lim, Lee Fong Siow, Jamaliah Md. Jahim, Abdul Wahab Mohammad, Wen Hui Teoh. "Recent Advances in the Application of Inorganic Salt Pretreatment for Transforming Lignocellulosic Biomass into Reducing Sugars", *Journal of Agricultural and Food Chemistry*, 2015

Publication

<1%

258

microbialcellfactories.biomedcentral.com

Internet Source

<1%

259

www.lib.utexas.edu

Internet Source

<1%

260

Submitted to Georgia State University

Student Paper

<1%

261

Maftuchah, , Agus Zainudin, Robby Wahyu Pahlevi, and Arik Anggriawan. "Molecular and Histochemical Analysis of *Jatropha Curcas* Linn. Transgenic Using Tolerance Antibiotics Hygromycin (hpt) and β -Glucuronidase (gus-A) Gene", *Energy Procedia*, 2015.

Publication

<1%

262

Florence Boulanger. "Quantitative immunolocalization of four immunodominant

<1%

antigens of *Toxoplasma gondii*", *Biology of the Cell*, 1991

Publication

263 A. Haberkorn. "Chemotherapy of human and animal coccidiosis: state and perspectives", *Parasitology Research*, 02/29/1996 <1%

Publication

264 Guido Marle. "Human immunodeficiency virus type 1 genetic diversity in the nervous system: Evolutionary epiphenomenon or disease determinant?", *Journal of NeuroVirology*, 4/1/2005 <1%

Publication

265 Submitted to Charles Sturt University <1%

Student Paper

266 www.internationalscholarsjournals.org <1%

Internet Source

267 opus.uni-hohenheim.de <1%

Internet Source

268 DuBok Choi. "Effects of *Fomitopsis pinicola* extracts on antioxidant and antitumor activities", *Biotechnology and Bioprocess Engineering*, 10/2007 <1%

Publication

269 Submitted to Heriot-Watt University <1%

Student Paper

270	www.apjtc.com Internet Source	<1%
271	Li, Duan, Yong Long, Tingcai Wang, Dan Xiao, Jingxia Zhang, Zhiwen Guo, Bo Wang, and Yongping Yan. "Epidemiology of Hepatitis C Virus Infection in Highly Endemic HBV Areas in China", PLoS ONE, 2013. Publication	<1%
272	Submitted to Concord University Student Paper	<1%
273	Submitted to South Bank University Student Paper	<1%
274	Methods in Pharmacology and Toxicology, 2016. Publication	<1%
275	www.openaire.eu Internet Source	<1%
276	Sadeq Hassan Al-Sheraji, Amin Ismail, Mohd Yazid Manap, Shuhaimi Mustafa, Rokiah Mohd Yusof, Fouad Abdulrahman Hassan. "Purification, characterization and antioxidant activity of polysaccharides extracted from the fibrous pulp of Mangifera pajang fruits", LWT - Food Science and Technology, 2012 Publication	<1%

Submitted to KDU College Sdn Bhd

277	Student Paper	<1%
278	ejournal-s1.undip.ac.id Internet Source	<1%
279	Angus, C. W., Diane Klivington-Evans, J. P. Dubey, and Joseph A. Kovacs. "Immunization with a DNA Plasmid Encoding the SAG1 (P30) Protein of <i>Toxoplasma gondii</i> Is Immunogenic and Protective in Rodents", <i>The Journal of Infectious Diseases</i> , 2000. Publication	<1%
280	Submitted to University of Alabama at Birmingham Student Paper	<1%
281	apps.who.int Internet Source	<1%
282	phytopharmacyresearch.com Internet Source	<1%
283	bmcbiotechnol.biomedcentral.com Internet Source	<1%
284	repository.royalholloway.ac.uk Internet Source	<1%
285	Daniel L. Clark. "Localization of renal oxidative stress and inflammatory response after lithotripsy", <i>BJU International</i> , 06/2009	<1%

286 t-pacient.ru <1 %
Internet Source

287 actavetscand.biomedcentral.com <1 %
Internet Source

288 Ghazanfari, S, Z Mohammadi, and M Adib Moradi. "Effects of Coriander Essential Oil on the Performance, Blood Characteristics, Intestinal Microbiota and Histological of Broilers", *Revista Brasileira de Ciência Avícola*, 2015. <1 %
Publication

289 www.journal.unair.ac.id <1 %
Internet Source

290 rcp-platform.com <1 %
Internet Source

291 farmasi.unhas.ac.id <1 %
Internet Source

292 Submitted to University of Strathclyde <1 %
Student Paper

293 www.embl.de <1 %
Internet Source

294 patrec.cs.tu-dortmund.de <1 %
Internet Source

295	Submitted to Yeditepe University Student Paper	<1%
296	Submitted to Our Lady of Fatima University Student Paper	<1%
297	www.acponline.org Internet Source	<1%
298	Submitted to University of New South Wales Student Paper	<1%
299	Submitted to University of Kent at Canterbury Student Paper	<1%
300	Submitted to Claflin University Student Paper	<1%
301	cora.ucc.ie Internet Source	<1%
302	Lusida, Maria. "Predominance of precore mutations and clinical significance of basal core promoter mutations in chronic hepatitis B virus infection in Indonesia", Biomedical Reports, 2013. Publication	<1%
303	www.ics-ir.org Internet Source	<1%
304	www.ubmthai.com Internet Source	<1%

305	ses.library.usyd.edu.au Internet Source	<1%
306	medforum.pk Internet Source	<1%
307	Alexandrina L. Dumitrescu. "Periodontal Microbiology", Etiology and Pathogenesis of Periodontal Disease, 2010 Publication	<1%
308	Sutini, Mochamad Sodik, Wirdhatul Muslihatin, Mochamad Rasjad Indra. "Production of secondary metabolites trimethyl xanthina by <i>Camellia sinensis</i> L suspension culture", AIP Publishing, 2017 Publication	<1%
309	preview-bmcsystbiol.biomedcentral.com Internet Source	<1%
310	www.google.co.in Internet Source	<1%
311	genome.cshlp.org Internet Source	<1%
312	www.ijrpc.com Internet Source	<1%
313	Submitted to Thames Valley University Student Paper	<1%

314 Thomas J. Raub. "P-Glycoprotein Recognition of Substrates and Circumvention through Rational Drug Design", Molecular Pharmaceutics, 2006 <1%
Publication

315 J.-L. Pons. "Evaluation of antimicrobial interactions between chlorhexidine, quaternary ammonium compounds, preservatives and excipients", Journal of Applied Microbiology, 11/1992 <1%
Publication

316 Hofseth, L.J.. "Nitric oxide as a target of complementary and alternative medicines to prevent and treat inflammation and cancer", Cancer Letters, 20080908 <1%
Publication

317 Submitted to Loughborough University <1%
Student Paper

318 open.bu.edu <1%
Internet Source

319 Lertlakana Bhoopat. "Cell Reservoirs of the Epstein-Barr Virus in Biopsy-proven Lymphocytic Interstitial Pneumonitis in HIV-1 Subtype E Infected Children : Identification by Combined In Situ Hybridization and Immunohistochemistry", Applied

Immunohistochemistry & Molecular Morphology, 05/2010

Publication

320

www.hri.global

Internet Source

<1%

321

Bodhade, Ashish S., Sindhu M. Ganvir, and Vinay K. Hazarey. "Oral manifestations of HIV infection and their correlation with CD4 count", *Journal of Oral Science*, 2011.

Publication

<1%

322

Ashwini Tilay, Mahesh Bule, Uday Annapure. "Production of Biovanillin by One-Step Biotransformation Using Fungus *Pycnoporous cinnabarinus*", *Journal of Agricultural and Food Chemistry*, 2010

Publication

<1%

323

Submitted to Universiti Teknikal Malaysia Melaka

Student Paper

<1%

324

ABC Transporters - 40 Years on, 2016.

Publication

<1%

325

Submitted to Universiti Malaysia Pahang

Student Paper

<1%

326

"Committees", 2015 IEEE International Broadband and Photonics Conference (IBP), 2015.

<1%

327 www.dqb.fc.ul.pt <1 %
Internet Source

328 Submitted to University of Oklahoma <1 %
Student Paper

329 C Nucci, W.D da Silveira, S da Silva Corrêa, G Nakazato, S.Y Bando, M.A Ribeiro, A.F Pestana de Castro. "Microbiological comparative study of isolates of *Edwardsiella tarda* isolated in different countries from fish and humans", *Veterinary Microbiology*, 2002 <1 %
Publication

330 www.kapukonline.com <1 %
Internet Source

331 www.malariajournal.com <1 %
Internet Source

332 ppsub.ub.ac.id <1 %
Internet Source

333 Sheng-Qiu, T, D Xiao-Ying, J Chun-Mei, P Jing-Jing, L Shan-Shan, and C Jin-Ding. "Effect of *Bacillus subtilis natto* on growth performance in Muscovy ducks", *Revista Brasileira de Ciência Avícola*, 2013. <1 %
Publication

334 Aty Widyawaruyanti. "New prenylated flavones <1 %

from *Artocarpus champeden*, and their antimalarial activity in vitro", *Journal of Natural Medicines*, 08/27/2007

Publication

335 Breeding and Biotechnology of Tea and its Wild Species, 2014. <1%

Publication

336 www.medicina.unal.edu.co <1%

Internet Source

337 www.medsci.uu.se <1%

Internet Source

338 modishop.com <1%

Internet Source

339 "Antimicrobial Drug Resistance", Springer Nature, 2017 <1%

Publication

340 www.ascls.org <1%

Internet Source

341 "Chemical constituents and anti-tuberculosis activity of ink extracts of cuttlefish, *Sepiella inermis*", *Journal of Coastal Life Medicine*, 2013 <1%

Publication

342 Submitted to Consorcio CIXUG <1%

Student Paper

343	www.ijat-aatsea.com Internet Source	<1%
344	Chen, J.. "Characterization and antioxidant activity of Ginkgo biloba exocarp polysaccharides", Carbohydrate Polymers, 20120104 Publication	<1%
345	Liping Du, Hongyan Niu, Xuekuang Zhang, Dongguang Xiao. "Preparation of Glucan Sulfates with Different Degree of Substitution and Their Immunoprophylaxis Potentials in Escherichia coli Induced Mice Peritonitis", 2010 4th International Conference on Bioinformatics and Biomedical Engineering, 2010 Publication	<1%
346	www.ijipsr.com Internet Source	<1%
347	new.ijlbpr.com Internet Source	<1%
348	bibapp.mbl.edu Internet Source	<1%
349	H. Nurhayati. " The effect of fertilizer to growth and quality of perennial sow-thistle (L.) ", Acta Horticulturae, 2016 Publication	<1%

350	thejns.org Internet Source	<1%
351	www.omicsgroup.com Internet Source	<1%
352	Jiang, Lun, Jing-Tao Wu, and Xin Peng. "Primary choriocarcinoma of the colon: a case report and review of the literature", World Journal of Surgical Oncology, 2013. Publication	<1%
353	Matthew D. Bramlett. "Assessing a multilevel model of young children's oral health with national survey data", Community Dentistry And Oral Epidemiology, 03/2010 Publication	<1%
354	www.publichealth.bham.ac.uk Internet Source	<1%
355	Flichman, Diego M, Jorgelina L Blejer, Beatriz I Livellara, Viviana E Re, Sonia Bartoli, Juan A Bustos, Claudia P Ansola, Susana Hidalgo, Martin E Cerda, Alicia E Levin, Adriana Huenul, Victoria Riboldi, Elena MC Treviño, Horacio J Salamone, Felix A Nuñez, Robert J Fernández, Juan F Reybaud, and Rodolfo H Campos. "Prevalence and trends of markers of hepatitis B virus, hepatitis C virus and human Immunodeficiency virus in Argentine blood	<1%

donors", BMC Infectious Diseases, 2014.

Publication

356 virologyj.biomedcentral.com <1 %
Internet Source

357 www.elsevier.es <1 %
Internet Source

358 Świzdor, Alina, Anna Panek, Natalia Milecka-Tronina, and Teresa Kołek. "Biotransformations Utilizing β -Oxidation Cycle Reactions in the Synthesis of Natural Compounds and Medicines", International Journal of Molecular Sciences, 2012. <1 %
Publication

359 doc.rero.ch <1 %
Internet Source

360 Minu, K.. "Isolation and purification of lignin and silica from the black liquor generated during the production of bioethanol from rice straw", Biomass and Bioenergy, 201204 <1 %
Publication

361 Marsh, A.. "Differentiation of Neospora hughesi from Neospora caninum based on their immunodominant surface antigen, SAG1 and SRS2", International Journal for Parasitology, 199910 <1 %
Publication

362	www.drugs.com Internet Source	<1%
363	Submitted to Jawaharlal Nehru Technological University Student Paper	<1%
364	Zoonoses - Infections Affecting Humans and Animals, 2015. Publication	<1%
365	malariajournal.biomedcentral.com Internet Source	<1%
366	Robert Elston. "Resistance to HIV Non-Nucleoside Reverse Transcriptase Inhibitors", Antimicrobial Drug Resistance, 2009 Publication	<1%
367	GÜLÇİN, İlhami, and Arif Daştan. "Synthesis of dimeric phenol derivatives and determination of in vitro antioxidant and radical scavenging activities", Journal of Enzyme Inhibition and Medicinal Chemistry, 2007. Publication	<1%
368	Luc J Martin. "Increase of antioxidant capacity of the lowbush blueberry (<i>Vaccinium angustifolium</i>) during fermentation by a novel bacterium from the fruit microflora", Journal of the Science of Food and Agriculture, 07/2005 Publication	<1%

369	paper Student Paper	<1%
370	M. Sobol, G. Skiba, S. Raj. "Effect of n – 3 polyunsaturated fatty acid intake on its deposition in the body of growing-finishing pigs", Animal Feed Science and Technology, 2015 Publication	<1%
371	www.aseanbiotechnology.info Internet Source	<1%
372	www.j3.jstage.jst.go.jp Internet Source	<1%
373	Submitted to Universiti Malaysia Perlis Student Paper	<1%
374	www.iscientific.org Internet Source	<1%
375	T. Utsumi. "Complete Genome Sequence and Phylogenetic Relatedness of Hepatitis B Virus Isolates in Papua, Indonesia", Journal of Clinical Microbiology, 04/22/2009 Publication	<1%
376	paperity.org Internet Source	<1%
377	www.vhpb.org Internet Source	<1%

378	bloodjournal.hematologylibrary.org Internet Source	<1%
379	ejournal.undip.ac.id Internet Source	<1%
380	A. Bonhomme. "Toxoplasma gondii-structure variations of the antigen P30", Parasitology, 04/1994 Publication	<1%
381	doktori.bibl.u-szeged.hu Internet Source	<1%
382	dmauldin.gdxbase.org Internet Source	<1%
383	Submitted to TED Universitas Student Paper	<1%
384	jamanetwork.com Internet Source	<1%
385	Submitted to Middle Tennessee State University Student Paper	<1%
386	Ohshima, Mitsuhiro, Yoko Yamaguchi, Kichibee Otsuka, Masashi Sato, and Masako Ishikawa. "Laminin Expression by Human Periodontal Ligament Fibroblasts", Connective Tissue Research, 2006. Publication	<1%

387	www.ospar.org Internet Source	<1%
388	www.aaaai.org Internet Source	<1%
389	Emmanoel Vilaça Costa, Francisco A. Marques, Maria Lúcia B. Pinheiro, Nelissa P. Vaz et al. "7,7-Dimethylaporphine Alkaloids from the Stem of ", Journal of Natural Products, 2009 Publication	<1%
390	jpkc.fimmu.com Internet Source	<1%
391	Bin Du, Baojun Xu. "Oxygen radical absorbance capacity (ORAC) and ferric reducing antioxidant power (FRAP) of β -glucans from different sources with various molecular weight", Bioactive Carbohydrates and Dietary Fibre, 2014 Publication	<1%
392	www.journalijdr.com Internet Source	<1%
393	Singh, Indu, Rajan Swami, Manish Kumar Jeengar, Wahid Khan, and Ramakrishna Sistla. "p-Aminophenyl- α -d-mannopyranoside engineered lipidic nanoparticles for effective delivery of docetaxel to brain", Chemistry and Physics of Lipids, 2015.	<1%

-
- 394 Artur Javmen, Aušra Nemeikaitė-Čėnienė, Saulius Grigiškis, Jelena Lysovienė et al. "The effect of *Saccharomyces cerevisiae* β -glucan on proliferation, phagocytosis and cytokine production of murine macrophages and dendritic cells", *Biologia*, 2017
Publication <1%
-
- 395 www.sigmaaldrich.com
Internet Source <1%
-
- 396 www.lca4ports.eu
Internet Source <1%
-
- 397 Submitted to University of Iowa
Student Paper <1%
-
- 398 adr.iadrjournals.org
Internet Source <1%
-
- 399 Jasim M. Albandar. "Risk factors for periodontitis in children and young persons", *Periodontology* 2000, 6/2002
Publication <1%
-
- 400 scholarworks.uaeu.ac.ae
Internet Source <1%
-
- 401 Shin, H.R.. "Prevalence and risk factors of hepatitis C virus infection among Koreans in rural area of Korea", *Hepatology Research*, <1%

200006

Publication

402

e-dergi.marmara.edu.tr

Internet Source

<1%

403

Muhammed Shafeekh Muiyyarikkandy, Mary Amalaradjou. "Lactobacillus bulgaricus, Lactobacillus rhamnosus and Lactobacillus paracasei Attenuate Salmonella Enteritidis, Salmonella Heidelberg and Salmonella Typhimurium Colonization and Virulence Gene Expression In Vitro", International Journal of Molecular Sciences, 2017

Publication

<1%

404

Tenkorang, Eric Y. Maticka-Tyndale, Eleanor. "Individual- and community-level influences on the timing of sexual debut among youth in Nyanza, Kenya", International Perspectives on Sexual and Reproductive Health, June 2014 Issue

Publication

<1%

405

Aazam Aarabi, Maryam Mizani, Masoud Honarvar. "The use of sugar beet pulp lignin for the production of vanillin", International Journal of Biological Macromolecules, 2017

Publication

<1%

406

Submitted to Perdana Leadership Foundation

Student Paper

<1%

407 Converti, A., B. Aliakbarian, J.M. DomÃnguez, G. Bustos VÃ¡zquez, and P. Perego. "Microbial production of biovanillin", Brazilian Journal of Microbiology, 2010. <1%

Publication

408 macrothink.org <1%

Internet Source

409 ejournal.litbang.kemkes.go.id <1%

Internet Source

410 ajcn.nutrition.org <1%

Internet Source

411 D. Schaap, A.N. Vermeulen, C.W. Roberts, J. Alexander. "Vaccination Against Toxoplasmosis: Current Status and Future Prospects", Elsevier BV, 2007 <1%

Publication

412 Jones, C. K., M. Bubser, A. D. Thompson, J. W. Dickerson, N. Turle-Lorenzo, M. Amalric, A. L. Blobaum, T. M. Bridges, R. D. Morrison, S. Jadhav, D. W. Engers, K. Italiano, J. Bode, J. S. Daniels, C. W. Lindsley, C. R. Hopkins, P. J. Conn, and C. M. Niswend. "The Metabotropic Glutamate Receptor 4-Positive Allosteric Modulator VU0364770 Produces Efficacy Alone and in Combination with L-DOPA or an Adenosine 2A Antagonist in Preclinical Rodent Models of Parkinson's Disease", Journal of

Pharmacology and Experimental Therapeutics, 2012.

Publication

- 413 Sukla, S., T. K. Bhattacharya, R. T. Venkatachalapathy, P. Kumar, and A. Sharma. "Molecular cloning and characterization of buffalo α 1-casein gene : Full Length Research Paper", DNA Sequence, 2007. <1%
- Publication
-

- 414 Chen, Y. K., S. Q. Chen, X. Li, and S. Zeng. "Quantitative regioselectivity of glucuronidation of quercetin by recombinant UDP-glucuronosyltransferases 1A9 and 1A3 using enzymatic kinetic parameters", Xenobiotica, 2005. <1%
- Publication
-

- 415 Sukla, Soumi, Tarun K. Bhattacharya, R. T. Venkatachalapathy, Pushpendra Kumar, and Arjava Sharma. "Cloning and characterization of α 2-casein gene of Riverine buffalo : Full Length Research Paper", DNA Sequence, 2006. <1%
- Publication
-

- 416 Jurisic-Knezev, Dejana Bergougroux, Veronique Milde, David Fellner, Martin. "Auxin binding protein 4 is involved in the [Ca.sup.2+]/auxin-regulated expression of ZCAX3 gene in m", Botany, May 2014 Issue <1%
- Publication

417	Submitted to Texas A&M University, College Station Student Paper	<1%
418	Durkin, A.J.. "Defining the role of the epidermal growth factor receptor in pancreatic cancer grown in vitro", The American Journal of Surgery, 200311 Publication	<1%
419	rsc.anu.edu.au Internet Source	<1%
420	buy.ecplaza.net Internet Source	<1%
421	ir.lib.hiroshima-u.ac.jp Internet Source	<1%
422	M. Kizerwetter-Świda, M. Binek. "Assessment of potentially probiotic properties of Lactobacillus strains isolated from chickens", Polish Journal of Veterinary Sciences, 2016 Publication	<1%
423	Min Shi, Yingnan Yang, Xuansheng Hu, Zhenya Zhang. "Effect of ultrasonic extraction conditions on antioxidative and immunomodulatory activities of a Ganoderma lucidum polysaccharide originated from fermented soybean curd residue", Food Chemistry, 2014	<1%

424	www.biotek.lipi.go.id Internet Source	<1%
425	118.96.137.51:888 Internet Source	<1%
426	www.iar-anticancer.org Internet Source	<1%
427	circres.ahajournals.org Internet Source	<1%
428	www.najms.net Internet Source	<1%
429	Freitas, Solange Z, Rivaldo V da Cunha, Regina MB Martins, Sheila A Teles, Mary L Ibanhes, and Ana RC Motta-Castro. "Prevalence, genotypes and risk factors associated with hepatitis C virus infection in hemodialysis patients in Campo Grande, MS, Brazil", Memórias do Instituto Oswaldo Cruz, 2008. Publication	<1%
430	Submitted to South Dakota State University Student Paper	<1%
431	portalgaruda.ilkom.unsri.ac.id Internet Source	<1%

Leunga, Carrie Tsz-Tin. "Suprasegmental

432	<p>Features Are Not Acquired Early: Perception and Production of Monosyllabic Cantonese Lexical Tones in 4- to 6-Year-Old Preschool Children.(Research Article)(Report)", Journal of Speech, Language, and Hearing Research</p> <p>Publication</p>	<1%
433	<p>www.thefreelibrary.com</p> <p>Internet Source</p>	<1%
434	<p>www.heterocycles.jp</p> <p>Internet Source</p>	<1%
435	<p>www.jasn.org</p> <p>Internet Source</p>	<1%
436	<p>García-Piñeres, Alfonso J.. "Contribution to the elucidation of the anti-inflammatory activity of Sesquiterpene Lactones", Universität Freiburg, 2003.</p> <p>Publication</p>	<1%
437	<p>rff.net</p> <p>Internet Source</p>	<1%
438	<p>Vinke, C.M.. "The effects of surgical and chemical castration on intermale aggression, sexual behaviour and play behaviour in the male ferret (<i>Mustela putorius furo</i>)", Applied Animal Behaviour Science, 20081215</p> <p>Publication</p>	<1%
439	<p>Sanada, Chiho, Makoto Hasegawa, Akinori</p>	

Maezawa, and Shigeo Uchida. "Cr(III) Removal from Aqueous Solution by Alkaline Solution", International Journal of Advanced Research in Electrical Electronics and Instrumentation Engineering, 2006.

Publication

<1%

440

Pica, . "References", The Avian Erythrocyte Its Phylogenetic Odyssey, 2011.

Publication

<1%

441

Haryanto, Aris, Medania Purwaningrum, Sutopo Verawati, Sri Handayani Irianingsih, and Nastiti Wijayanti. "Pathotyping of Local Isolates Newcastle Disease Virus from Field Specimens by RT-PCR and Restriction Endonuclease Analysis", Procedia Chemistry, 2015.

Publication

<1%

442

Rollinson, Sara, Heather Kesby, and Gareth J. Morgan. "Haplotypic variation in MRE11, RAD50 and NBS1 and risk of non-Hodgkin's lymphoma", Leukemia & Lymphoma, 2006.

Publication

<1%

443

124.16.170.34

Internet Source

<1%

444

Sun Lin, Sumant Chugh, Xiaomin Pan, Elisabeth I. Wallner, Jun Wada, Yashpal S. Kanwar. "Identification of up-regulated Ras-like

<1%

GTPase, Rap1b, by suppression subtractive hybridization", *Kidney International*, 2001

Publication

-
- | | | |
|-----------------|--|-----|
| 445 | Kandathil, A. Kannangai, R. Verghese, V.. "Drug resistant mutations detected by genotypic drug resistance testing in patients failing therapy i", <i>Indian Journal of Medical Microbiology</i> , July-Sept 2009 Issue | <1% |
| Publication | | |
| 446 | www.bioinfoau.org | <1% |
| Internet Source | | |
| 447 | www.wseas.us | <1% |
| Internet Source | | |
| 448 | intl-toxsci.oxfordjournals.org | <1% |
| Internet Source | | |
| 449 | Federigo Sicuteri, Marcello Fanciullacci, Pierangelo Geppetti, Daniela Renzi, Daniela Caleri, Maria Grazia Spillantini. "Substance P Mechanism in Cluster Headache: Evaluation in Plasma and Cerebrospinal Fluid", <i>Cephalalgia</i> , 2016 | <1% |
| Publication | | |
| 450 | litbang.dephut.go.id | <1% |
| Internet Source | | |
| 451 | www.hoajonline.com | <1% |
| Internet Source | | |
-

452	Deepa Bisht. "Potential of Plant-Derived Products in the Treatment of Mycobacterial Infections", Modern Phytomedicine, 09/09/2006 Publication	<1%
453	Pai Peng. "A comparative study of bamboo (<i>Phyllostachys incarnata</i> Wen) milled wood lignin and the successively alkali-fractionated lignins", Wood Science and Technology, 11/08/2011 Publication	<1%
454	www.asiaandro.com Internet Source	<1%
455	Mau, J.-L.. "Antioxidant properties of several specialty mushrooms", Food Research International, 2002 Publication	<1%
456	Akshay K. Singh, Anjali Srivastava, Vivek Kumar, Karunakar Singh. "Phytochemicals, Medicinal and Food Applications of Shatavari (<i>Asparagus racemosus</i>): An Updated Review", The Natural Products Journal, 2018 Publication	<1%
457	etheses.saurashtrauniversity.edu Internet Source	<1%
458	uroweb.org Internet Source	<1%

459	www.myvmc.com Internet Source	<1%
460	www.esciencecentral.org Internet Source	<1%
461	www.aapd.org Internet Source	<1%
462	K. Kiyosawa, E. Tanaka, T. Sodeyama. "Hepatitis C Virus and Hepatocellular Carcinoma", S. Karger AG, 1998 Publication	<1%
463	www.emro.who.int Internet Source	<1%
464	posstrictosensu.iptsp.ufg.br Internet Source	<1%
465	Meta Dewi Thedja. "Ethnogeographical structure of hepatitis B virus genotype distribution in Indonesia and discovery of a new subgenotype, B9", Archives of Virology, 02/12/2011 Publication	<1%
466	www.naturalproduct.us Internet Source	<1%
467	ufh.netd.ac.za Internet Source	<1%

468	www.probiotic-conference.net Internet Source	<1%
469	jjmicrobiol.com Internet Source	<1%
470	jdmt.mums.ac.ir Internet Source	<1%
471	M.P. Singh, M.L. Dubey, A Sud, N. Malla. "Antibody response to in saliva samples from human immunodeficiency virus-infected patients ", British Journal of Biomedical Science, 2016 Publication	<1%
472	bmcoralhealth.biomedcentral.com Internet Source	<1%
473	Patton, LL, V Ramirez-Amador, G Anaya-Saavedra, W Nittayananta, M Carrozzo, and K Ranganathan. "Urban legends series: oral manifestations of HIV infection", Oral Diseases, 2013. Publication	<1%
474	Christian Fleige, Florian Meyer, Alexander Steinbüchel. "Metabolic Engineering of the Actinomycete Amycolatopsis sp. Strain ATCC 39116 towards Enhanced Production of Natural Vanillin", Applied and Environmental Microbiology, 2016	<1%

475 pages.cnpem.br <1 %
Internet Source

476 bioresources.cnr.ncsu.edu <1 %
Internet Source

477 Maciel, A.V., A.E. Job, W.N. Mussel, and V.M.D. Pasa. "Pyrolysis and auto-gasification of black liquor in presence of ZnO: An integrated process for Zn/ZnO nanostructure production and bioenergy generation", Biomass and Bioenergy, 2012. <1 %
Publication

478 pvj.com.pk <1 %
Internet Source

479 scholar.uwindsor.ca <1 %
Internet Source

480 Khalesi, Mohammadreza, Kurt Gebruers, David Riveros-Galan, Sylvie Deckers, Ali Akbar Moosavi-Movahedi, Hubert Verachtert, and Guy Derdelinckx. "Hydrophobin Purification Based on the Theory of CO₂-nanobubbles", Journal of Liquid Chromatography & Related Technologies, 2015. <1 %
Publication

481 www.spiedigitallibrary.org <1 %
Internet Source

482	www.theseus.fi Internet Source	<1%
483	www.research-collection.ethz.ch Internet Source	<1%
484	zidapps.boku.ac.at Internet Source	<1%
485	Morahem Ashengroph. "Novel strain of <i>Bacillus licheniformis</i> SHL1 with potential converting ferulic acid into vanillic acid", <i>Annals of Microbiology</i> , 06/17/2011 Publication	<1%
486	aricjournal.biomedcentral.com Internet Source	<1%
487	Fadi Kheder, Stéphane Delaunay, Ghassan Abo-Chameh, Cédric Paris, Lionel Muniglia, Michel Girardin. " Production and biochemical characterization of a type B ferulic acid esterase from ", <i>Canadian Journal of Microbiology</i> , 2009 Publication	<1%
488	bdtd.biblioteca.ufpb.br Internet Source	<1%
489	bmcsystbiol.biomedcentral.com Internet Source	<1%
490	Bandeira, Suziy de M., Glaucevane da S.	

Guedes, Lucas José S. da Fonseca, André S. Pires, Daniel P. Gelain, José Claudio F. Moreira, Luíza A. Rabelo, Sandra Mary L. Vasconcelos, and Marília Oliveira F. Goulart. "Characterization of Blood Oxidative Stress in Type 2 Diabetes Mellitus Patients: Increase in Lipid Peroxidation and SOD Activity", *Oxidative Medicine & Cellular Longevity*, 2012.

Publication

<1%

491

edoc.unibas.ch

Internet Source

<1%

492

Bastien, P.. "Molecular diagnosis of toxoplasmosis", *Transactions of the Royal Society of Tropical Medicine and Hygiene*, 200204

Publication

<1%

493

www.davidpublishing.com

Internet Source

<1%

494

Kazuhito Asano. "Tiotropium bromide inhibits TGF- β -induced MMP production from lung fibroblasts by interfering with Smad and MAPK pathways in vitro", *International Journal of Chronic Obstructive Pulmonary Disease*, 08/2010

Publication

<1%

495

N. Nenadis. "14 Assessing the activity of natural food antioxidants", *Oxidation in foods*

<1%

and beverages and antioxidant applications,
2010

Publication

496	www.bioflux.com.ro Internet Source	<1%
497	greenteax50.com.au Internet Source	<1%
498	Kızıl, Göksel, Murat Kızıl, Murat Yavuz, Sevil Emen, and Fidan Hakimoğlu. "Antioxidant Activities of Ethanol Extracts of <i>Hypericum triquetrifolium</i> . and <i>Hypericum scabroides</i> .", <i>Pharmaceutical Biology</i> , 2008. Publication	<1%
499	Submitted to Eastern Illinois University Student Paper	<1%
500	Martinez-Picado, J.. "HIV-1 reverse transcriptase inhibitor resistance mutations and fitness: A view from the clinic and ex vivo", <i>Virus Research</i> , 200806 Publication	<1%
501	www.cshmedicine.org Internet Source	<1%
502	avpivnik.ru Internet Source	<1%
503	Diaz, R.S.. "Selective regimes and evolutionary	<1%

rates of HIV-1 subtype B V3 variants in the
Brazilian epidemic", Virology, 20081125

Publication

504

dugi-doc.udg.edu

Internet Source

<1%

505

J. A. Gokhale. "Immunocytochemical
localization of Tamm-Horsfall protein in the
kidneys of normal and nephrolithic rats",
Urological Research, 08/1996

Publication

<1%

506

ethesis.nitrkl.ac.in

Internet Source

<1%

507

livestockscience.in

Internet Source

<1%

508

www.jclmm.com

Internet Source

<1%

509

Salim , Farah D. | Ahmed , Sundus H. | Ibrahim
, Kadhim M.. "Total Phenol Determent and
Antimicrobial and Anti-Inflammatory Activity of
the Extracts of Tagetes Patula L. Flowers \\
International Journal for Sciences and
Technology .- 2012 , Vol. 7 , No. 1 , pp. 71 -
76.", , 2012.

Publication

<1%

510

urduhomeopath.com

Internet Source

<1%

511	iris.unipa.it Internet Source	<1%
512	www.ijp-online.com Internet Source	<1%
513	www.bvv.sld.cu Internet Source	<1%
514	Fouad Abdulrahman Hassan, Amin Ismail, Azizah Abdulhamid, Azrina Azlan. " Identification and Quantification of Phenolic Compounds in Bambang (Kort.) Peels and Their Free Radical Scavenging Activity ", Journal of Agricultural and Food Chemistry, 2011 Publication	<1%
515	Jeng-Leun Mau, Guei-Rung Chao, Kaun-Tzer Wu. "Antioxidant Properties of Methanolic Extracts from Several Ear Mushrooms", Journal of Agricultural and Food Chemistry, 2001 Publication	<1%
516	D.L. Williams. "Preclinical and clinical evaluation of carbohydrate immunopharmaceuticals in the prevention of sepsis and septic sequelae", Innate Immunity, 06/01/1995 Publication	<1%

517 Jose, Polpass Arul Jebakumar, Solomon Ro. <1%
"Successive nonstatistical and statistical
approaches for the improved antibiotic activity
of rare ac", BioMed Research International,
Annual 2014 Issue
Publication

518 Kolečkar, Vit, Lubomir Opletal, Eliska <1%
Brojerova, Zuzana Rehakova, Frantisek
Cervenka, Katerina Kubikova, Kamil Kuca,
Daniel Jun, Miroslav Polasek, JIRI KUNES, and
Ludek Jahodar. "Evaluation of natural
antioxidants of Leuzea carthamoides as a
result of a screening study of 88 plant extracts
from the European Asteraceae and
Cichoriaceae", Journal of Enzyme Inhibition
and Medicinal Chemistry, 2008.
Publication

519 www.riubon.ac.th <1%
Internet Source

520 www.rilub.it <1%
Internet Source

521 allie.dbcls.jp <1%
Internet Source

522 www.google.com <1%
Internet Source

523

Internet Source

<1%

524

Submitted to Universitas Riau

Student Paper

<1%

525

www.rku.ac.in

Internet Source

<1%

526

Rafael Antonio Casarin Penha Filho, Silvia Juliana Acelas Díaz, Filipe Santos Fernando, Yung-Fu Chang et al. "Immunomodulatory activity and control of Salmonella Enteritidis colonization in the intestinal tract of chickens by Lactobacillus based probiotic", Veterinary Immunology and Immunopathology, 2015

Publication

<1%

527

Garvin, Peter, Lennart Nilsson, John Carstensen, Lena Jonasson, and Margareta Kristenson. "Plasma Levels of Matrix Metalloproteinase-9 are Independently Associated With Psychosocial Factors in a Middle-Aged Normal Population :", Psychosomatic Medicine, 2009.

Publication

<1%

528

N., M. Warrag, M. Tag Eldin I., and M. Ahmed E.. "Effect of Cymbopogon proximus (Mahareb) on ethylene glycol-induced nephrolithiasis in rats", African Journal of Pharmacy and

<1%

Pharmacology, 2014.

Publication

529 tigerprints.clemson.edu <1 %
Internet Source

530 M. J. Cuevas. "Suppression of
Amphiregulin/Epidermal Growth Factor
Receptor Signals Contributes to the Protective
Effects of Quercetin in Cirrhotic Rats", Journal
of Nutrition, 05/11/2011 <1 %
Publication

531 Md Jawaid Akhtar, M. Shahar Yar, Ahsan
Ahmed Khan, Zulphikar Ali, Md Rafi Haider.
"Recent Advances in the Synthesis and
Anticancer Activity of Some Molecules Other
Than Nitrogen Containing Heterocyclic
Moeities", Mini-Reviews in Medicinal
Chemistry, 2017 <1 %
Publication

532 Zhang, Z.. "Enhanced Therapeutic Effect on
Androgen-Independent Prostate Cancer by
Depsipeptide (FK228), a Histone Deacetylase
Inhibitor, in Combination with Docetaxel",
Urology, 200708 <1 %
Publication

533 Suvi Manner, Malena Skogman, Darla Goeres,
Pia Vuorela, Adyary Fallarero. "Systematic
Exploration of Natural and Synthetic <1 %

Flavonoids for the Inhibition of Staphylococcus aureus Biofilms", International Journal of Molecular Sciences, 2013

Publication

- 534 Osman, Neamt H. A., Usama Z. Said, Ahmed M. El-Waseef, and Esraa S. A. Ahmed. "Luteolin supplementation adjacent to aspirin treatment reduced dimethylhydrazine-induced experimental colon carcinogenesis in rats", Tumor Biology, 2015.

Publication

- 535 Jonas A. Rodrigues. "Prevention of crown and root caries in adults : Prevention of crown and root caries in adults", Periodontology 2000, 02/2011

Publication

- 536 L. Hariprasath, R. Jegadeesh, P. Arjun, N. Raaman. "In vitro propagation of Senecio candicans DC and comparative antioxidant properties of aqueous extracts of the in vivo plant and in vitro-derived callus", South African Journal of Botany, 2015

Publication

- 537 hzi.openrepository.com

Internet Source

- 538 ijapsbs.com

Internet Source

- 539 Cheng-Wei Lin. "12-O-tetradecanoylphorbol-13-acetate-induced invasion/migration of glioblastoma cells through activating PKC α /ERK/NF- κ B-dependent MMP-9 expression", Journal of Cellular Physiology, 2010
Publication <1%
-
- 540 www.astdd.org
Internet Source <1%
-
- 541 www.benthamopen.com
Internet Source <1%
-
- 542 Farshadpour, Fatemeh, Reza Taherkhani, Saeed Tajbakhsh, Marziyeh Gholizadeh Tangestani, Gholamreza Hajiani, Nasrin Sharifi, Sakineh Taherkhani, and Abdolreza Nejadbolkehr. "Prevalence and Trends of Transfusion-Transmissible Viral Infections among Blood Donors in South of Iran: An Eleven-Year Retrospective Study", PLoS ONE, 2016.
Publication <1%
-
- 543 repository.kulib.kyoto-u.ac.jp
Internet Source <1%
-
- 544 Marcel G. R. ter Veld, Bastiaan Schouten, Jochem Louisse, Daan S. van Es et al. "Estrogenic Potency of Food-Packaging-Associated Plasticizers and Antioxidants As <1%

Detected in ER α and ER β Reporter Gene Cell Lines", Journal of Agricultural and Food Chemistry, 2006

Publication

545

scihub.org

Internet Source

<1%

546

www.tipharma.com

Internet Source

<1%

547

sbhepatologia.org.br

Internet Source

<1%

548

Bouchra Kitab, Abdellah Essaid El Feydi, Rajaa Afifi, Omar Derdabi et al. "Hepatitis B genotypes/subgenotypes and MHR variants among Moroccan chronic carriers", Journal of Infection, 2011

Publication

<1%

549

www.med.kobe-u.ac.jp

Internet Source

<1%

550

Kurt S. Zaenker. "Paving Roads for New Drugs in Oncology", Recent Patents on Anti-Cancer Drug Discovery, 06/01/2009

Publication

<1%

551

mpera.mt.gov

Internet Source

<1%

552

"Bottlenecks and Hubs in Inferred Networks Are

<1%

Important for Virulence in *Salmonella typhimurium*", Journal of Computational Biology, 01/29/2009

Publication

553 revistas.inia.es <1 %
Internet Source

554 www.rroij.com <1 %
Internet Source

555 arizona.openrepository.com <1 %
Internet Source

556 hivbook.files.wordpress.com <1 %
Internet Source

557 M. Moodley. "Gestational trophoblastic syndrome: An audit of 112 patients. A South African experience", International Journal of Gynecological Cancer, 3/2003
Publication

558 ourarchive.otago.ac.nz <1 %
Internet Source

559 Ocon, Susan, Christina Murphy, Angeline T. Dang, Sumathi Sankaran-Walters, Chin-Shang Li, Ross Tarara, Niku Borujerdpur, Satya Dandekar, Bruce J. Paster, and Michael D. George. "Transcription Profiling Reveals Potential Mechanisms of Dysbiosis in the Oral Microbiome of Rhesus Macaques with Chronic

Untreated SIV Infection", PLoS ONE, 2013.

Publication

-
- | | | |
|-----|--|-----|
| 560 | Mostafa Nokta. "Oral manifestations associated with HIV infection", Current HIV/AIDS Reports, 02/2008
Publication | <1% |
| 561 | David Andrean, Susiana Prasetyo, Anastasia Prima Kristijarti, Tedi Hudaya. "The Extraction and Activity Test of Bioactive Compounds in Phaleria Macrocarpa as Antioxidants", Procedia Chemistry, 2014
Publication | <1% |
| 562 | Advanced Structured Materials, 2016.
Publication | <1% |
| 563 | ediss.sub.uni-hamburg.de
Internet Source | <1% |
| 564 | globenewswire.com
Internet Source | <1% |
| 565 | etd.auburn.edu
Internet Source | <1% |
| 566 | dspace.unitus.it
Internet Source | <1% |
| 567 | Mathew, Sindhu, and T. Emilia Abraham. "Bioconversions of Ferulic Acid, an Hydroxycinnamic Acid", Critical Reviews in | <1% |

Microbiology, 2006.

Publication

568 Lalitendu Das, Praveen Kolar, Ratna Sharma-Shivappa, John Classen, Jason Osborne. "Oxidative Depolymerization of Lignin Using Supported Niobium Catalysts", ChemEngineering, 2017

Publication

569 eprints.uwe.ac.uk

Internet Source

570 Devin J Rose. "Utilisation of corn (*Zea mays*) bran and corn fiber in the production of food components", Journal of the Science of Food and Agriculture, 2010

Publication

571 mrmjournal.biomedcentral.com

Internet Source

572 Maria Maximina B. Moreno-Altamirano, Oscar Rodríguez-Espinosa, Oscar Rojas-Espinosa, Bernardo Pliego-Rivero et al. "Dengue Virus Serotype-2 Interferes with the Formation of Neutrophil Extracellular Traps", Intervirology, 2015

Publication

573 "Encyclopedia of Membranes", Springer Nature, 2016

Publication

574

www.e-webplayground.net

Internet Source

<1%

575

Maftuchah, , and Agus Zainudin. "In Vitro Selection of *Jatropha Curcas* Linn. Hybrids Using Polyethylene Glycol to Obtain Drought Tolerance Character", *Procedia Chemistry*, 2015.

Publication

<1%

576

Camelia Papuc, Gheorghe V. Goran, Corina N. Predescu, Valentin Nicorescu, Georgeta Stefan. "Plant Polyphenols as Antioxidant and Antibacterial Agents for Shelf-Life Extension of Meat and Meat Products: Classification, Structures, Sources, and Action Mechanisms", *Comprehensive Reviews in Food Science and Food Safety*, 2017

Publication

<1%

577

Jordan, J.L., A.M. Sullivan, and T.D.G. Lee. "Immune Activation by a Sterile Aqueous Extract of *Cordyceps Sinensis*: Mechanism of Action", *Immunopharmacology and Immunotoxicology*, 2008.

Publication

<1%

578

Bo KONG. "Display of aggregation-prone ligand binding domain of human PPAR gamma on surface of bacteriophage lambda1", *Acta Pharmacologica Sinica*, 1/2006

<1%

579 www.paolobellavite.it <1 %
Internet Source

580 researchbank.rmit.edu.au <1 %
Internet Source

581 www.google.com.mx <1 %
Internet Source

582 J. Auta. "Nucleic Acid Quantitation Using the Competitive Polymerase Chain Reaction", Handbook of Neurochemistry and Molecular Neurobiology, 2007 <1 %
Publication

583 Fayza Sayed Mohamed Habib. "Sequential recognition of antigenic markers of Toxoplasma gondii tachyzoite by pooled sera of mice with experimental toxoplasmosis", Parasitology Research, 09/22/2010 <1 %
Publication

584 www.commonwealthvetassoc.org <1 %
Internet Source

585 cid.oxfordjournals.org <1 %
Internet Source

586 www.karlstorz.com <1 %
Internet Source

587 pubs.sciepub.com

Internet Source

<1%

588

repository.osakafu-u.ac.jp

Internet Source

<1%

589

thorax.bmj.com

Internet Source

<1%

590

www.anesthesia-analgesia.org

Internet Source

<1%

591

Ohara, Kazuyuki Uchida, Asako Nagasaka, .
"The effects of hydroxycinnamic acid
derivatives on adiponectin secretion.(Report)",
Phytomedicine: International Journal of , March
2009 Issue

Publication

<1%

592

Kramer, Frank, and Alex Dusek. "Biomarkers of
Lung Tissue Remodeling in Pulmonary
Diseases: Implications for Clinical Practice and
Research", Current Respiratory Medicine
Reviews, 2012.

Publication

<1%

593

www.termia.pl

Internet Source

<1%

594

worldwidescience.org

Internet Source

<1%

595

www.mmnp-journal.org

Internet Source

<1%

596

hyper.ahajournals.org

Internet Source

<1%

597

www.ajronline.org

Internet Source

<1%

598

wwwnc.cdc.gov

Internet Source

<1%

599

X. Li. "Hepatitis B Virus (HBV) Subgenotypes C2 and B2 Differ in Lamivudine- and Adefovir-Resistance-Associated Mutational Patterns in HBV-Infected Chinese Patients", Journal of Clinical Microbiology, 12/01/2010

Publication

<1%

600

Nagalingeswaran Kumarasamy. "Rapid viral load suppression following generic highly active antiretroviral therapy in Southern Indian HIV-infected patients", AIDS, 04/2005

Publication

<1%

601

www.oncotarget.com

Internet Source

<1%

602

www.clusterportal-bw.de

Internet Source

<1%

603

apnmr2007.life.nthu.edu.tw

Internet Source

<1%

604 Ozturk, M.. "Antioxidant activity of stem and root extracts of Rhubarb (*Rheum ribes*): An edible medicinal plant", *Food Chemistry*, 2007 <1%
Publication

605 Brul, Stanley, Frans Klis, Klaas Hellingwerf, and Piet de Groot. "Molecular organization and biogenesis of the cell wall", *Metabolism and Molecular Physiology of Saccharomyces Cerevisiae* 2nd Edition, 2004. <1%
Publication

606 Rolf Gebhardt, Jan G. Hengstler, Dieter Müller, Reinhild Glöckner et al. "New Hepatocyte In Vitro Systems for Drug Metabolism: Metabolic Capacity and Recommendations for Application in Basic Research and Drug Development, Standard Operation Procedures", *Drug Metabolism Reviews*, 2003 <1%
Publication

607 Jiunn H. Lin, Masayo Yamazaki. "Clinical Relevance of P-Glycoprotein in Drug Therapy", *Drug Metabolism Reviews*, 2003 <1%
Publication

608 KENDO KIYOSAWA. "Review of hepatitis C in Japan", *Journal of Gastroenterology and Hepatology*, 8/1991 <1%
Publication

609 M Amin, A Bakhtiar, M Subarjo, EB Aksono, P

Widiyanti, K Shimizu, Y Mori. "Screening for Middle East respiratory syndrome coronavirus among febrile Indonesian Hajj pilgrims: A study on 28,197 returning pilgrims", Journal of Infection Prevention, 2018

Publication

<1%

610

Biomass and Bioenergy, 2014.

Publication

<1%

611

Methods in Molecular Biology, 2015.

Publication

<1%

612

"RNAi and Small Regulatory RNAs in Stem Cells", Springer Nature, 2017

Publication

<1%

613

Dan Turner. "Prevalence of the K65R resistance reverse transcriptase mutation in different HIV-1 subtypes in Israel", Journal of Medical Virology, 09/2009

Publication

<1%

614

"List of Abstract", European Heart Journal Supplements, 2018

Publication

<1%

615

JOH, Seong-Joon, Min-Jeong KIM, Hyuk-Man KWON, Eun-Hye AHN, Hwan JANG, and Jun-Hun KWON. "Characterization of Edwardsiella tarda Isolated from Farm-Cultured Eels, Anguilla japonica, in the Republic of Korea", Journal of Veterinary Medical Science, 2011.

<1%

616 Xu, Xin, Qin Huang, Yulong Mao, Zhiwen Cui, Yali Li, Yi Huang, Imran Rashid Rajput, Dongyou Yu, and Weifen Li. "*Immunomodulatory effects of Bacillus subtilis (natto) B4 spores on murine macrophages : Effects of on macrophages*", *Microbiology and Immunology*, 2012.

Publication

617 "*Nutrition and Oral Medicine*", Springer Nature, 2014

Publication

618 B. Rochat. "*Importance of Influx and Efflux Systems and Xenobiotic Metabolizing Enzymes in Intratumoral Disposition of Anticancer Agents*", *Current Cancer Drug Targets*, 08/01/2009

Publication

619 *Proteases and Their Receptors in Inflammation*, 2011.

Publication

620 Kamollerd, Chuchat, Preeyaporn Surachon, Punchompoo Maunglai, Wilailak Siripornadulsil, and Peerapol Sukon. "*Assessment of probiotic potential of Lactobacillus reuteri MD5-2 isolated from ceca of Muscovy ducks*", *Korean Journal of*

621 RUNCANG SUN. "Separation and Characterization of Lignins from the Black Liquor of Oil Palm Trunk Fiber Pulping", Separation Science and Technology, 11/1/1999 <1%
Publication

622 Gallage, N. J., and B. L. Moeller. "Vanillin - Bioconversion and Bioengineering of the most popular plant flavour and its de novo biosynthesis in the vanilla orchid", Molecular Plant, 2014. <1%
Publication

623 Puente-Garza, César A., Antonia Gutiérrez-Mora, and Silverio García-Lara. "Micropropagation of Agave salmiana: Means to Production of Antioxidant and Bioactive Principles", Frontiers in Plant Science, 2015. <1%
Publication

624 Afsaneh Noormandi, Fatemeh Dabaghzadeh. "Effects of green tea on Escherichia coli as a uropathogen", Journal of Traditional and Complementary Medicine, 2015 <1%
Publication

625 Hans Gerhard Vogel. "Chapter 6 Psychotropic and Neurotropic Activity", Springer Nature, 2007 <1%

626

U. M. Parikh. "The K65R Mutation in Human Immunodeficiency Virus Type 1 Reverse Transcriptase Exhibits Bidirectional Phenotypic Antagonism with Thymidine Analog Mutations", *Journal of Virology*, 05/15/2006

<1%

Publication

627

Lin, Z.M.. "Hepatitis B virus of genotype C persistence after recovery from acute hepatitis B virus infection in Japan", *Hepatology Research*, 200303

<1%

Publication

Exclude quotes On
Exclude bibliography Off

Exclude matches < 5 words

Analyze Activation Marker of Azurophilic Granule (CD63) and CFSE CD11C Expressions of Salivary Neutrophils Insevere Early Childhood Caries.

GRADEMARK REPORT

FINAL GRADE

/100

GENERAL COMMENTS

Instructor

PAGE 1

PAGE 2

PAGE 3

PAGE 4

PAGE 5

PAGE 6

PAGE 7

PAGE 8

PAGE 9

PAGE 10

PAGE 11

PAGE 12

PAGE 13

PAGE 14

PAGE 15

PAGE 16

PAGE 17

PAGE 18

PAGE 19

PAGE 20

PAGE 21

PAGE 22

PAGE 23

PAGE 24

PAGE 25

PAGE 26

PAGE 27

PAGE 28

PAGE 29

PAGE 30

PAGE 31

PAGE 32

PAGE 33

PAGE 34

PAGE 35

PAGE 36

PAGE 37

PAGE 38

PAGE 39

PAGE 40

PAGE 41

PAGE 42

PAGE 43

PAGE 44

PAGE 45

PAGE 46

PAGE 47

PAGE 48

PAGE 49

PAGE 50

PAGE 51

PAGE 52

PAGE 53

PAGE 54

PAGE 55

PAGE 56

PAGE 57

PAGE 58

PAGE 59

PAGE 60

PAGE 61

PAGE 62

PAGE 63

PAGE 64

PAGE 65

PAGE 66

PAGE 67

PAGE 68

PAGE 69

PAGE 70

PAGE 71

PAGE 72

PAGE 73

PAGE 74

PAGE 75

PAGE 76

PAGE 77

PAGE 78

PAGE 79

PAGE 80

PAGE 81

PAGE 82

PAGE 83

PAGE 84

PAGE 85

PAGE 86

PAGE 87

PAGE 88

PAGE 89

PAGE 90

PAGE 91

PAGE 92

PAGE 93

PAGE 94

PAGE 95

PAGE 96

PAGE 97

PAGE 98

PAGE 99

PAGE 100

PAGE 101

PAGE 102

PAGE 103

PAGE 104

PAGE 105

PAGE 106

PAGE 107

PAGE 108

PAGE 109

PAGE 110
