

PharmaScientia

VOL. 2021, 2, 181-188 (2021)

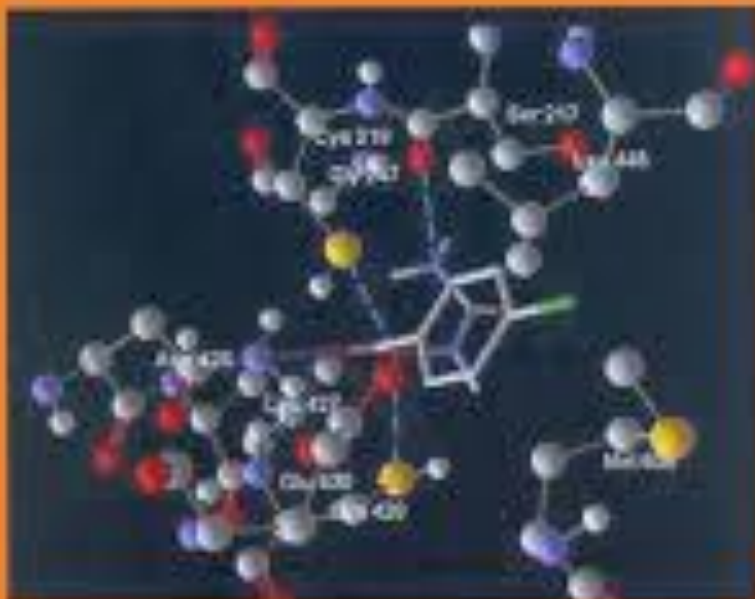

RESEARCH
DEPARTMENT PHARMACEUTICAL CHEMISTRY
UNIVERSITY ABRUZZO

Table of Content PHARM

PharmaScientia

ISSN : 2302-0725

Volume 1 / Nomor : 1 / Published : 2012-07

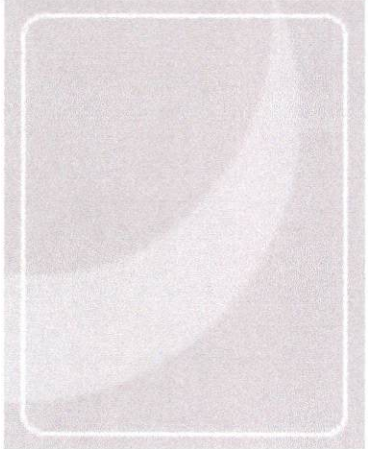
Cover Media	Content
	<ol style="list-style-type: none">1. Karakteristik sediaan dan pelepasan natrium diklofenak dalam sistem niosom dengan basis gel carbomer 9402. Physical characterization and in vitro release study on theophylline-chitosan microparticles (effect on crosslinking time and method of preparation)3. Characterisation of solid lipid nanoparticles p-methoxycinnamic acid (sln-pmca) formulated with different lipid component: stearic acid and cetyl alcohol4. Pengaruh penambahan manitol terhadap pelepasan ranitidin hcl dari tablet floating dengan hpmc k100m sebagai matriks5. The influence of niosome system (span 20/60-cholesterol) on the preparation characteristics and released of diclofenac sodium from gel carbopol etd 2020

Information PharmaScientia

Susunan Dewan Redaksi

Dewan Redaksi

Ketua : Dra. Hj. Esti Hendradi, MSi., PhD., Apt.

Anggota : Prof. Dr. Widji Soeratri, DEA., Apt.

Dr. H. Achmad Radjaram, Apt.

Redaksi Pelaksana: Dewi Melani Hariyadi, SSi., MPhil., PhD., Apt.

Ari Ardhi Asih Setjowijono, S.Pd.

Alamat Redaksi : Fakultas Farmasi Universitas Airlangga

Jl. Dharmawangsa Dalam, Surabaya 60286

Telp. 031-5033710, Fax. 031-5020514

**THE INFLUENCE OF NIOSOME SYSTEM (SPAN 20/60-
CHOLESTEROL) ON THE PREPARATION CHARACTERISTICS AND
RELEASED OF DICLOFENAC SODIUM FROM GEL CARBOPOL ETD**

2020

Esti Hendradi^{1*}, Tutiek Purwanti¹, Atika Rizkia Noviani¹, Riza Ariesta Hellinda¹

¹Department of Pharmaceutics of Faculty of Pharmacy, Airlangga University, Surabaya

*Corresponding author: esti_hendradi@yahoo.com

ABSTRACT

The purpose of the study was to determine the influence of niosome system that was formed by span (20/60) and cholesterol in molar ratio of sodium diclofenac, span (20/60), and cholesterol = 1:6:6 on the preparation characteristics and released of diclofenac sodium from gel carbopol ETD 2020. Formula I and II was a control of gel using Span 20 and 60, respectively. Formula III and IV were gel of diclofenac sodium that was prepared into niosome system with Span 20 and 60, respectively. The released was done by diffusion cell and cellophane membrane. Released of diclofenac sodium from all formulation was shown by value of flux and analyzed by statistic. The result of diclofenac-Span 20/60-cholesterol showed that there was a significant difference between formula I and formula III; formula II and formula IV ; formula III and formula IV. The conclusion was niosome system that was formed by span (20/60) and cholesterol in molar ratio of sodium diclofenac, span 20, and cholesterol = 1:6:6 influenced on the preparation characteristics and increased the released of diclofenac sodium from gel. The highest released of diclofenac sodium was from niosom system of sodium diclofenac, span 60, and cholesterol with molar ratio=1:6:6.

Keywords: Niosome, diclofenac sodium, carbopol ETD 2020, Span 20, Span 60, released of diclofenac.

INTRODUCTION

Transdermal delivery offers several advantages over the conventional drug therapy, including avoidance of gastrointestinal irritation, elimination pass metabolism, minimization of pain, and possible sustained release of drugs. The main barrier for absorption the compound through the skin is stratum corneum. Diffusion of the drug through stratum corneum is affected by released of drug from the based. Released of drug from the based is affected by physicochemical of the drug such as

solubility, partition and interaction of drug to the based. Diclofenac sodium is NSAID, the drug causes gastric irritation and undergoes hepatic first-pass metabolism (40-50%) (Ganiswara, 1995). Diclofenac sodium has log P 1.13 (Budavari et al, 2001), so it hydrophobic compound and has small solubility in water and distribution in the gel based not well. One of the method to increase distribution in the gel based by made vesicle, niosome (Choi and Maibach, 2005). Niosome is well documented for transdermal drug

delivery. Niosome system is unilamellar or multilamellar vesicle where in an aqueous solution is enclosed in highly ordered bilayer made up of nonionic surfactant with or without cholesterol and dicetyl phosphate (Biju et al, 2006). The recent study, to improve the released of diclofenac, a niosome composed of Span 20/60, cholesterol was prepared. In this study, the influence of niosome system on preparation characteristics and released of diclofenac sodium from carbopol ETD 2020 was evaluated.

MATERIALS AND METHODS

Materials

Diclofenac sodium was obtained as a gift sample from PT Dexa Medika, Carbopol ETD 2020, Trietanolamin (TEA) p.a, Sodium Edetate (Na-EDTA) p.a and propyleneglycol were purchased from PT. Tristar (Surabaya, Indonesia), Span 60 was obtained as a gift sample from PT Surya Dermato, Span 20, and Cholesterol (Sigma), KCl (E.Merck), NaCl p.a (E.Merck), Na₂HPO₄.12 H₂O p.a (E.Merck), dan KH₂PO₄ p.a (E.Merck). Compound was used without mention the specification was a pharmaceutical grade. All ingredient were used without further purification.

Preparation and characterization of niosome

Niosomes were prepared by using Reverse Phase Evaporation Technique (REV). The molar ratio of diclofenac sodium, Span 20/60 and cholesterol is 1:6:6. Drug, non ionic surfactant and Cholesterol were weighed as indicated in Table 1. Cholesterol and Span were dissolved in chloroform, diclofenac sodium in aquadest than mixed and sonification at temperature 4-5⁰C for 12 minutes. The mixture was added PBS pH 7.4 ± 0.05 and sonification at 4-5⁰C

for 4 minutes. Than the mixture was rotavapored at 40⁰C, 300 mmHg until chloroform disappeared (± 2 h) and the end evaporated at waterbath until 2 h to make the niosome system.

Determination of the entrapment diclofenac sodium in the niosome system.

The entrapment of diclofenac in the niosome system was calculated using equation 1:

$$Ep (\%) = \left[\frac{(C_t - C_f)}{C_t} \right] \times$$

100%.....1)

Where,

Ep : diclofenac sodium entrapment in the niosome system

C_f : concentration of diclofenac free (un entrapped)

C_t : total concentration of diclofenac sodium in the formulation of niosome system.

Determination of pH on the formulation

The pH of preparation was done by mixed the preparation in the aqua free of CO₂ in ratio 1:9. Mix well and than the pH of preparation was measured using pHmeter.

Determination of diclofenac released from the preparation.

Permeation study was performed apparatus 5 paddle over disk completely with diffusion cell (Figure 1) at 37⁰C for 6 h. As a membrane was cellophane and as donor compartment was filled by preparation of niosome system in carbopol ETD 2020 gel. As receptor solution was phosphate buffer saline pH 7.4. At the appropriate time sample was

taken from receptor solution.

Tabel 1. Formula of niosome system (Span 20/60-Cholesterol) in Gel of Carbopol ETD 2020

	FI	FII	FIII	FIV
Diclofenac Sod*	0.200 g	0.200 g	-	-
Span 20	1.2996 g	-	-	-
Span 60	-	1.6206 g	-	-
Cholesterol	1.4480 g	1.4480 g	-	-
PBS	2.8 ml	3 ml	-	-
Niosome	-	-	15.5250 g**	14.0905 g**
Carbopol gel	ad 20 g	ad 20 g	ad 20 g	ad 20 g

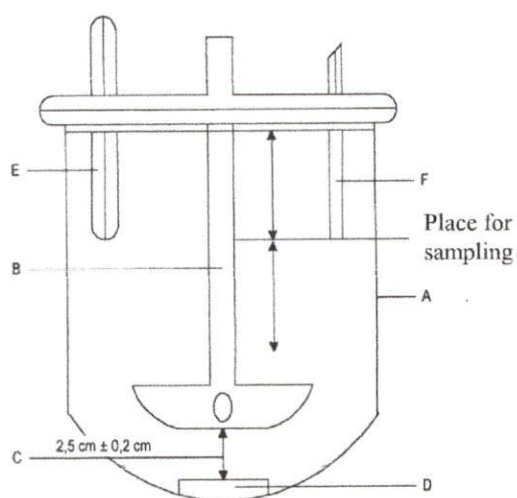

- A : Diffusion chamber contain PBS pH 7.4
 C : Distance from paddle to diffusion membrane
 D : Diffusion cell
 E : Thermometer
 F : Sample holder

Figure 1. Apparatus 5-paddle Over Disk (The United States Pharmacopeial Convention, 2002)

Diclofenac concentration of sample solution was measured using Spectrophotometer. Released of equation 2 (Higuchi, 1959).
 diclofenac sodium was calculated using

$$Q = \frac{q}{x} = [Dt (2A-C_s) C_s]^{1/2} \dots\dots\dots(2)$$

Where,
 Q = flux of drug released
 D = coefficient diffusion of drug in the based
 A = concentration of drug in the based
 C_s = solubility of drug in the based
 t = time

RESULTS AND DISCUSSION

The percent entrapment of diclofenac sodium in the niosome system was shown at the Figure 2. Percent efficiency entrapment although with Span 60 higher compare with that Span 20, but insignificant different.

The pH value of FI - FIII, and FII - FIV were increased significant different. It means the niosome system increased the pH preparation (Figure 3)

Flux is the most useful index to evaluate the released of drug. The cumulative amount of drug released was plotted as function of root time. From the result of linear regression of steady state condition I get flux at the slope. As shown in the Figure 4, the released profile shows the sufficient linearity with the coefficient r was ≥ 0.98.

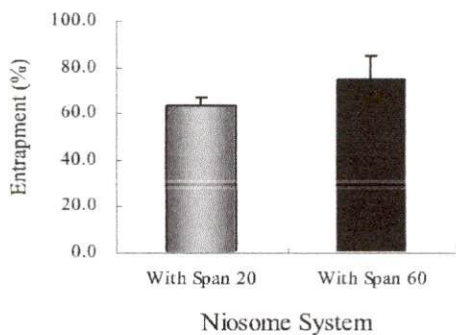

Figure 2. The diclofenac sodium was entrapped (%) in the niosome system.

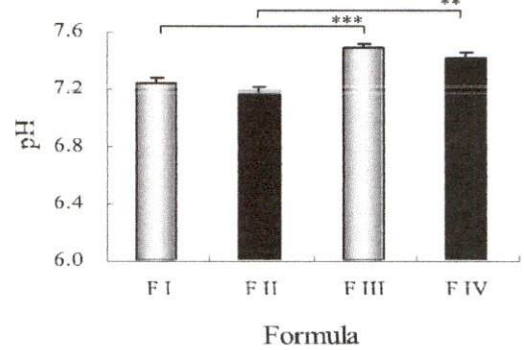

Figure 3. The pH value of the formulation

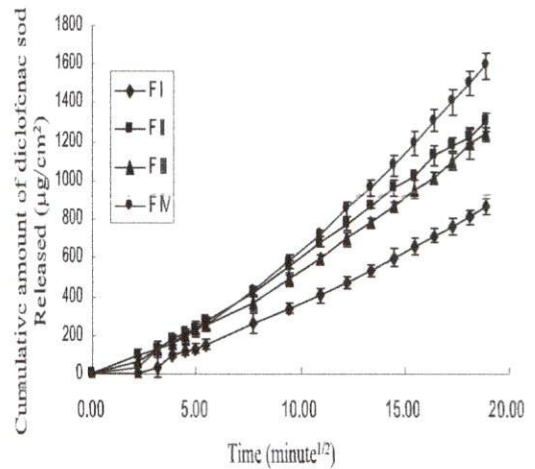

Figure 4. Released profile of diclofenac sodium through cellophane membrane in preparation of niosome system (F III and IV) and control (F I and F II) from Carbopol ETD 2020 gel based.

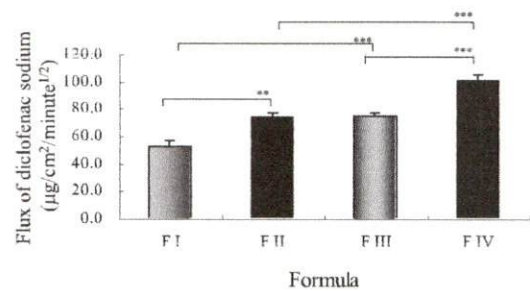

Figure 5. Flux of diclofenac sodium from preparation of niosome system in Carbopol ETD 2020 gel.

In Figure 5 shown the flux of diclofenac from preparation of niosome system diclofenac sodium: Span 60: cholesterol with molar ratio 1:6:6 in Carbopol ETD 2020 gel based was significantly increased compared with that of control. It suggested that the niosome system increased the flux of diclofenac sodium from Carbopol ETD 2020 gel based. The mechanism of increasing flux released of diclofenac sodium suggestion was the increasing solubility of drug in the Carbopol ETD 2020 gel based. Flux of diclofenac sodium from niosome with composition diclofenac sodium: Span 60: cholesterol was higher compared with flux of diclofenac sodium with composition diclofenac sodium: Span 20: cholesterol probably it caused Span 60 more hydrophobic than Span 20. So, the released of diclofenac sodium in niosome system with Span 60 from the Carbopol ETD 2020 gel based was higher compared with that of Span 20.

CONCLUSIONS

The pH of the preparation of niosome system significantly increased compared with control. The flux of diclofenac significantly increased by the administration of niosome system. The greatest flux was observed in the niosome system of Span 60.

REFERENCES

- Biju, S.S., Sushama,T., Mishra P.R., Khar R.K., (2006). Vesicular Systems: An Overview, *Review Article*, Vol. 68(2), pp. 141-153.
- Budavari, S., (2001). *The Merck Index: An Encyclopedia of Chemicals, Drugs And Biological*, 13th Edition, Book 1, USA: Merck and Co., Inc, pp. 3106
- Choi, M. J., Maibach, H. I., (2005). Liposomes and Niosomes as Topical Drug Delivery Systems, *Skin Pharmacology and Physiology 2005, Journal of Pharmacological and Biophysiological Research*, Vol. 18, No. 5, pp.209-219.
- Ganiswara, S. G., (1995). *Farmakologi dan Terapi*, Edisi IV, Jakarta: Bagian Farmakologi FKUI, hal. 207-209, 219
- Higuchi, T., (1959). *Physical Chemical Analysis of Percutaneous Absorption Process From Creams and Ointments*. Presented September 23-24, 1959, Seminar, New York City
- Shahiwala, A., Misra, A., (2002). Studies in Topical Application of Niosomally entrapped Nimesulide, *Journal of Pharmaceutical Sciences*, Vol. 5(3), pp. 220-225.
- The United States Pharmacopeial Convention, Inc., (2002). *The Official Compendia of Standards, The United States Pharmacopeia XXV and The National Formulary XIX*, Philadelphia, pp. 2011, 2018